

MONA

K 104

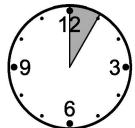
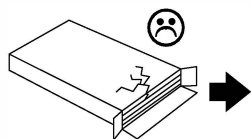
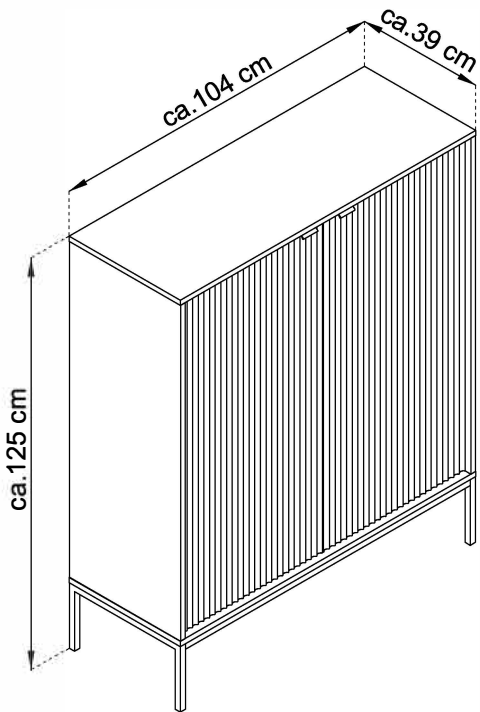
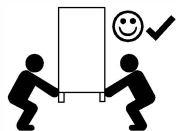
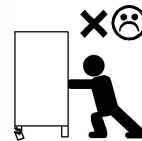
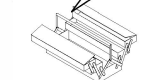
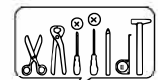
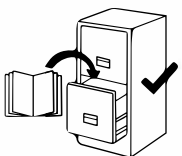
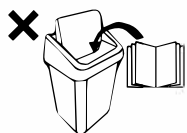
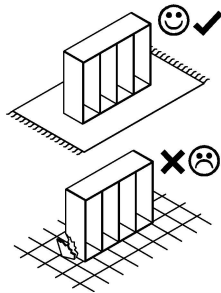
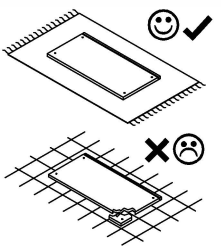

ca. 1,5H

- (D) Montageanleitung
- (FR) Notice de montage
- (NL) Handleiding voor de montage
- (CZ) Montážní návod
- (HU) Szerelési útmutató
- (TR) Montaj talimatı

- (GB) Assembly Instructions
- (IT) Istruzioni di montaggio
- (PL) Instrukcja montażu
- (SK) Návod na montáž
- (RO) Instrucțiuni de montaj
- (RU) Инструкции по монтажу

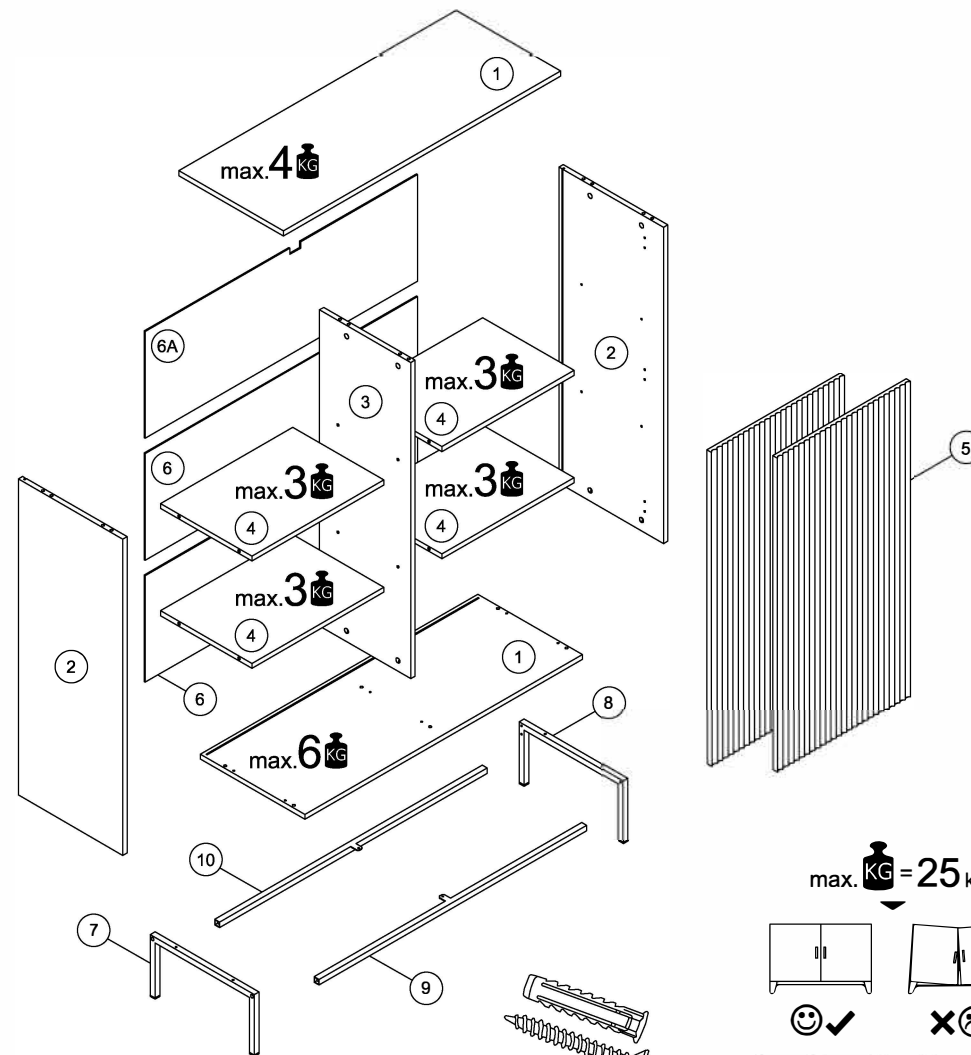

max. KG = 25 kg.

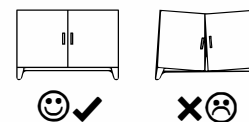

A	8x32	B	x12	B1	x20	C	x4	C	x28		
H0	x6	N	3x20	NS	3,5x13	NE	4x16	R6	x2		
TA	x1	WH	x6	X	x14	ZC	x16	Z	x12		

1	1035	390	16	x2	2 / 3
2	1023	390	16	x2	2 / 3
3	1023	341	16	x1	2 / 3
4	493	341	16	x4	2 / 3
5	1015	495	16	x2	3 / 3
6	1014	345	2.5	x2	2 / 3
6A	1014	345	2.5	x1	2 / 3
7	389	200	18	x1	1 / 3
8	389	200	18	x1	1 / 3
9	998	18	18	x1	1 / 3
10	998	18	18	x1	1 / 3

08.04.2022

! **Uwaga • Upozornění • Achtung • Attention • Caution • Figyelem**
Attenzione • Opgelet • Внимание • Atenție • Upozornenie • Dikkat !

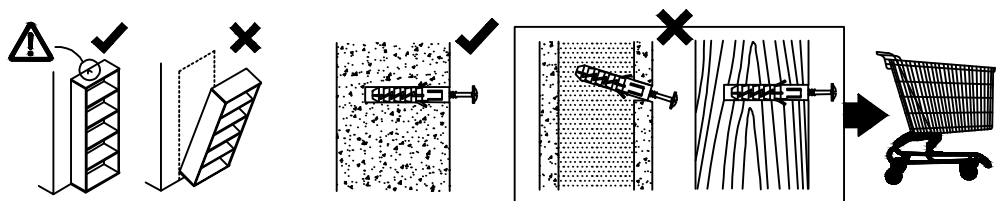
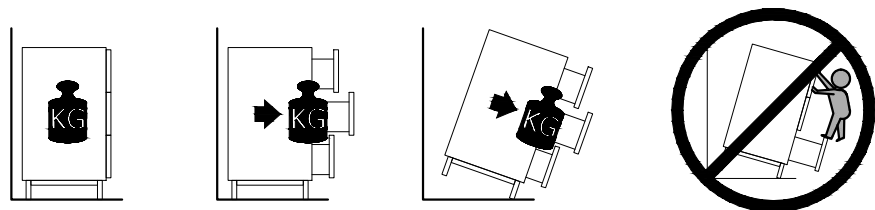

! **Uwaga • Upozornění • Achtung • Attention • Caution • Figyelem**
Attenzione • Opgelet • Внимание • Atenție • Upozornenie • Dikkat !

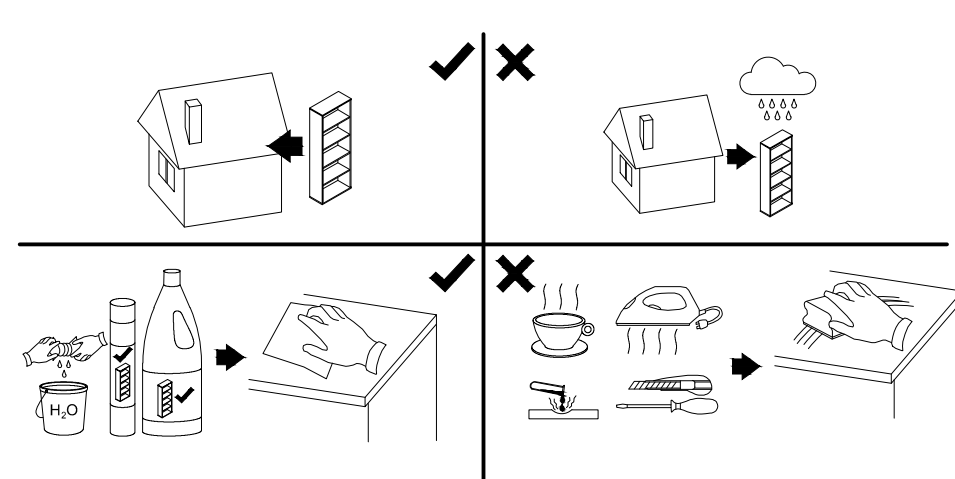

PL	Mocowanie do ściany jest jednocześnie zabezpieczeniem przed przewróceniem - koniecznie zamontować! Do niektórych rodzajów ścian koniecznie zastosować specjalne kołki mocujące.
CZ	Montáž na stěnu slouží jako ochrana proti převrnutí - bezpodmínečně umístěte! U některých typů stěn může být zapotřebí speciální hmoždinka!
DE	Wandbefestigung dient als Kippschutz - unbedingt anbringen! bei einigen Wandtypen kann ein Spezialdübel erforderlich sein!
GB	The wall fastening serves to prevent tipping - be absolutely sure to mount it! For certain wall types, a special wall plug may be necessary!
FR	La fixation murale sert de protection contre le basculement - à installer impérativement! Pour certains types de murs il faut des chevilles spéciales!
NL	Bevestiging aan de muur dient als kantelbescherming - zeker en vast bevestigen! Bij enkele muurtypen is een speciale plug misschien vereist!
IT	Il fissaggio alla parete serve da protezione anti-ribaltamento-attaccarla assolutamente! Per alcune strutture di parete può essere necessario un tassello speciale!
HU	A terméket a falhoz kel rögzíteni, különben az felborulhat! Egyes faltípusoknál speciális titlót kell használni!
RU	Обязательно установите крепление на стене во избежание опрокидывания! Для некоторых типов стен может потребоваться специальный дюбель!
RO	Sistemul de fixare la perete servește ca protecție la răsturnare - de montat obligatoriu! Pentru unele tipuri de pereți este posibil să fie necesar un diblu special!
SK	Upevnenie na stenu slúži ako ochrana proti prevráteniu - bezpodmienečne použite! Pre niektoré druhy stien môže byť potrebná špeciálna hmoždinka!
TR	Duvardaki sabitleme, devrilmeye karşı bir emniyet tedbiridir ve mutlaka monte edilmelidir! Bazi duvar tiplerinde bunun için özel bir dübel gerekli olabilir!

PL	Czyszczenie należy wykonać wyłącznie za pomocą ściereczki lub lekko nawilżonego ręcznika. Nie stosować środków czyszczących do szorowania.
CZ	Čistění je nutné vykonávat výhradně pomocí utěrky nebo lehce navlhčeného ručníku. Nepoužívejte čisticí prostředky obsahující abrazivní částice.
DE	Bitte nur mit einem Staubtuch oder leicht feuchtern Lappen reinigen. Keine scheuernden Putzmittel verwenden.
GB	Please only clean with a duster or damp cloth. Do not use any abrasive cleaners.
FR	Le nettoyage se fait uniquement à l'aide d'un torchon ou d'une serviette légèrement mouillée.
NL	Reinig alleen met een stofdoek of een lichtjes vochtige doek. Gebruik geen schurende poetsmiddelen.
IT	Pulire esclusivamente con un panno o un asciugamano umido.
HU	A tisztítás kizárólag törölrőruha vagy enyhén nedvesített törölköző segítségével végezhető. Súroló hatású tisztítószerket nem szabad használni.
RU	Очищайте от пыли тряпкой или слегка влажной ветошью. Не допускается применение чистящих средств, не предназначенных для ухода за мебелью.
RO	Curățarea trebuie efectuată numai cu o cârpă sau cu un prosop ușor umezit. Nu utilizați agenți de curățare abrazivi.
SK	Čistení je nutné vykonávať výhradne pomocí utierky alebo ľahko zvlhnutým ručníkom. Nepoužívajte čistiace prostriedky obsahujúce abrazívne častice.
TR	Lütfen sadece bir toz bezile veya hafif nemli yumuşak bir bezle siliniz. Aşındırıcı temizlik malzemeleri kullanmayınız.

1

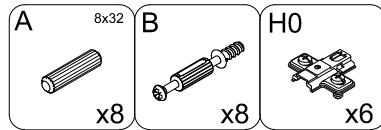
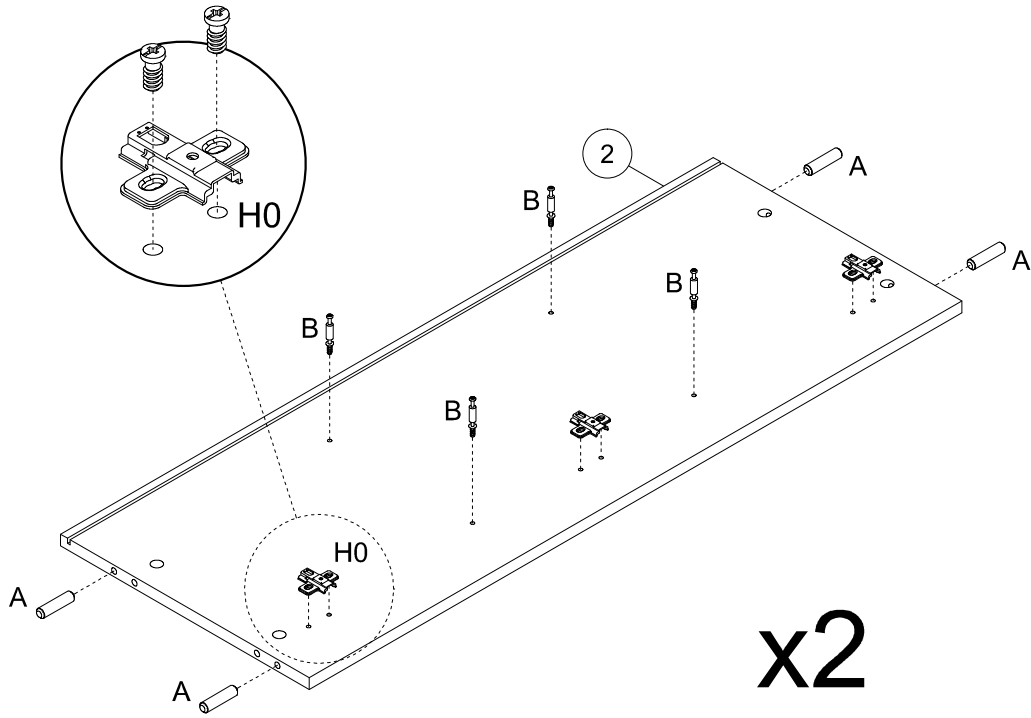
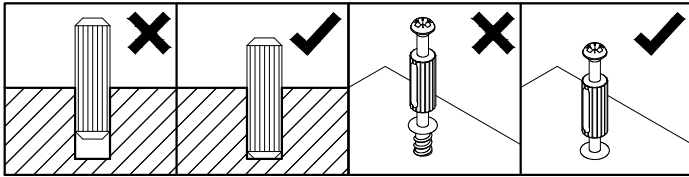

2

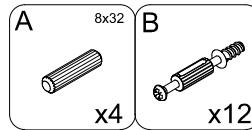
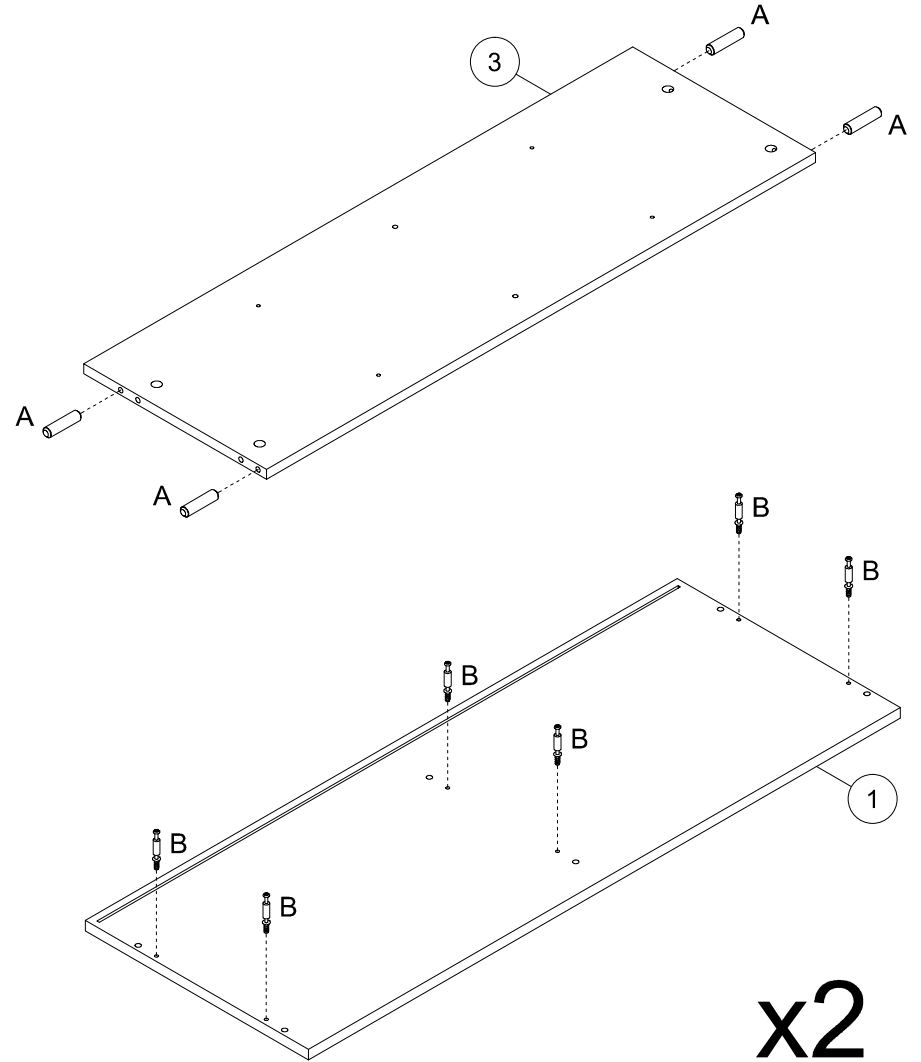

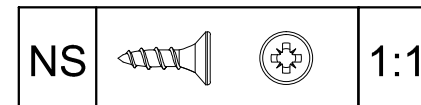
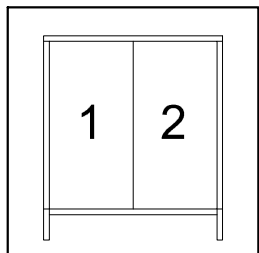
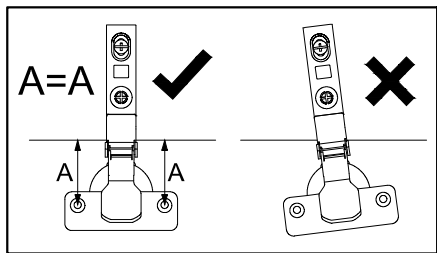

3

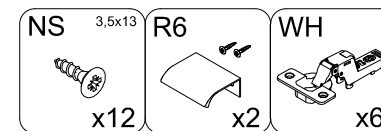
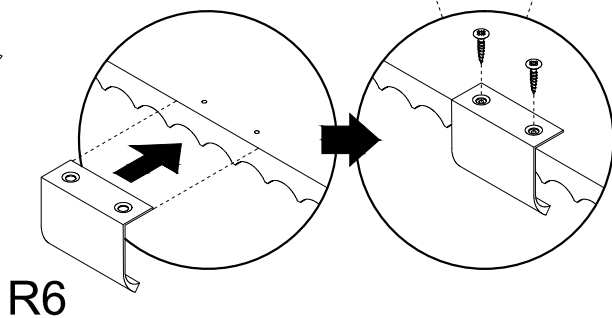
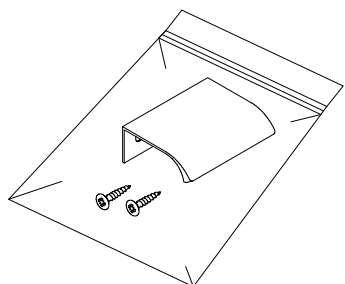
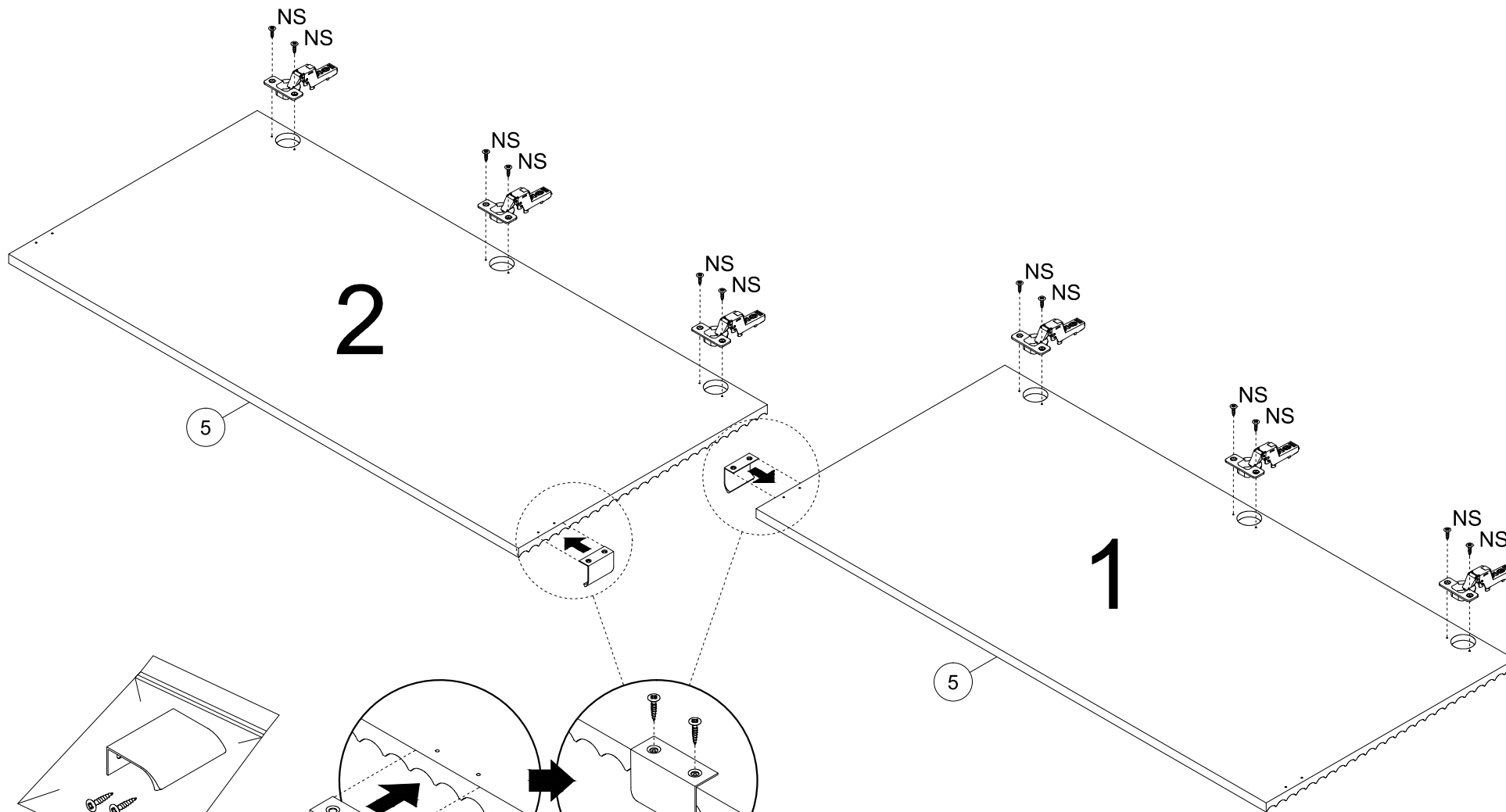

4

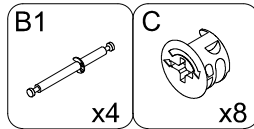
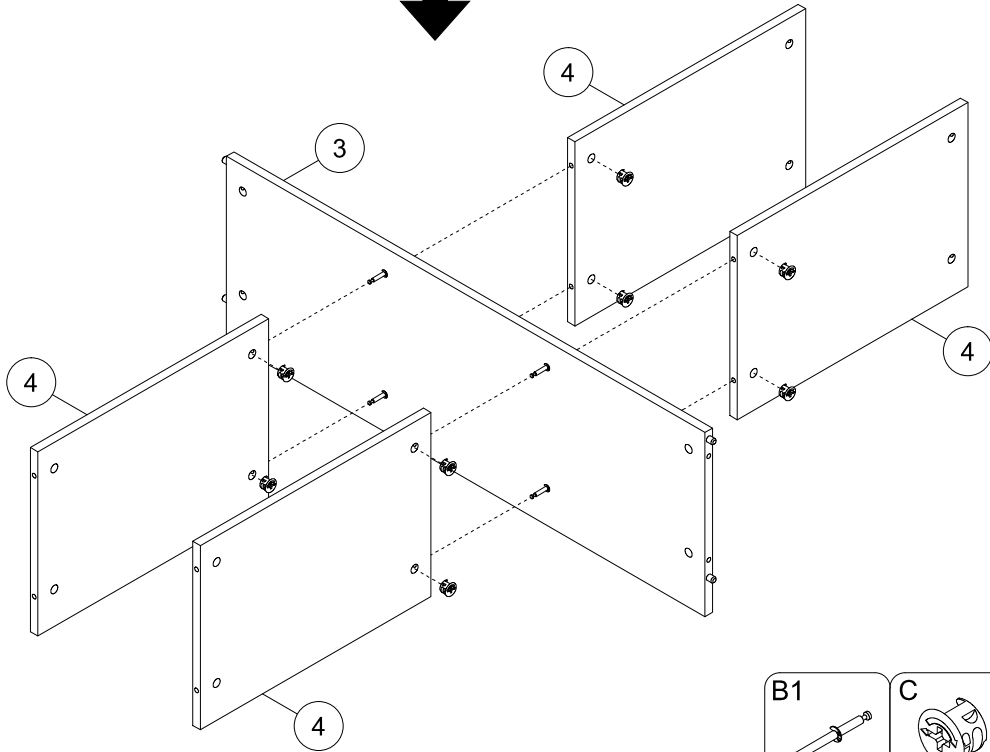
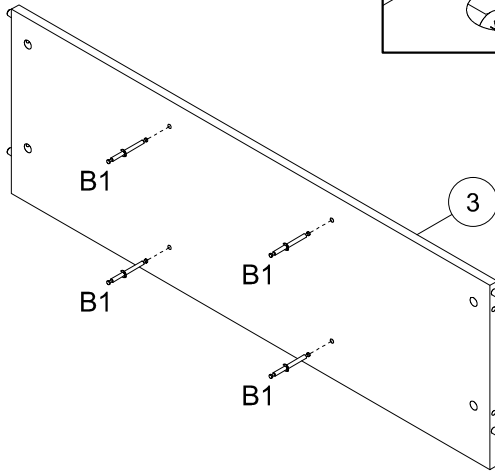
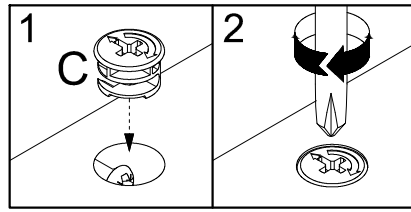

5

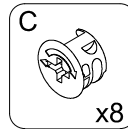
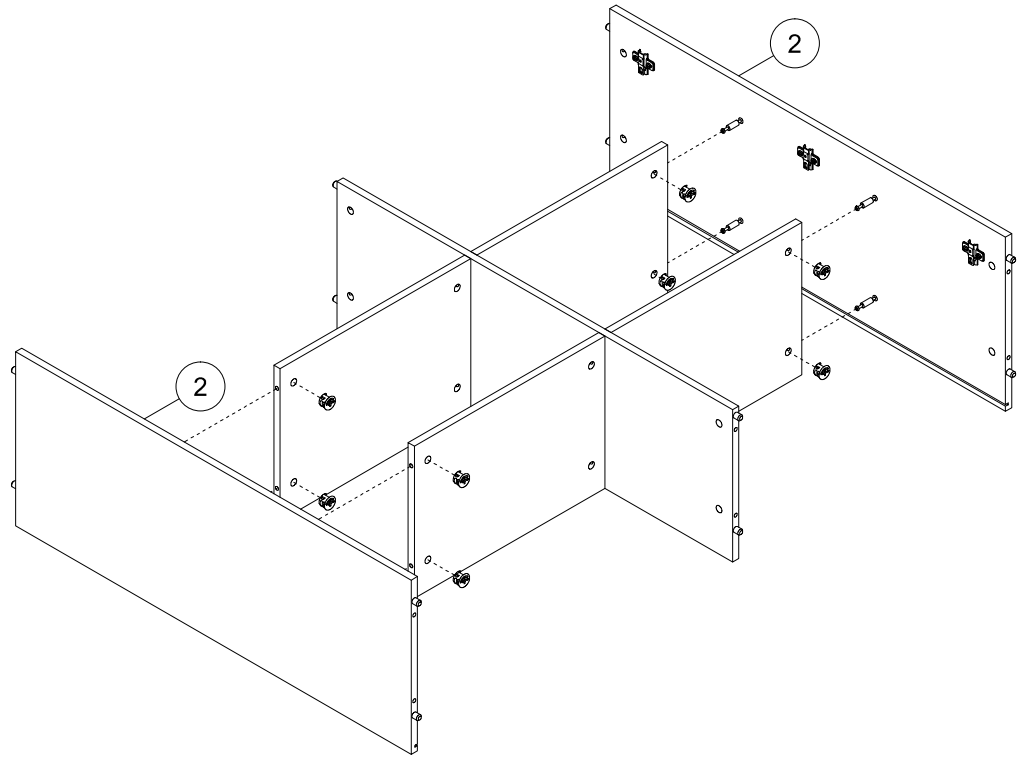
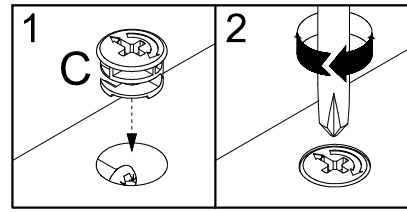

6

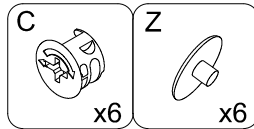
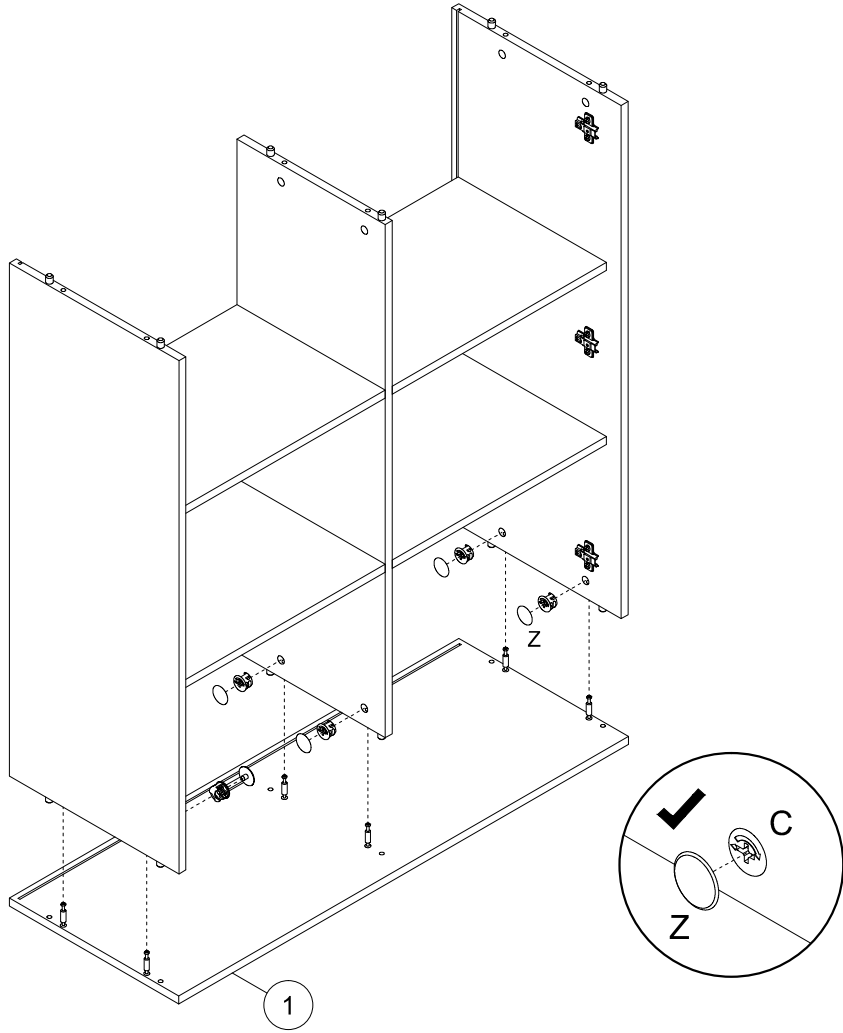
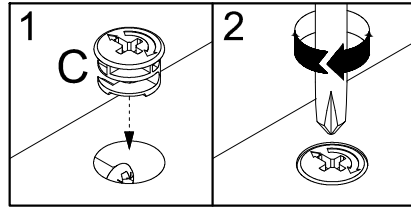

7

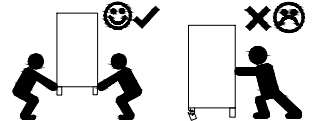
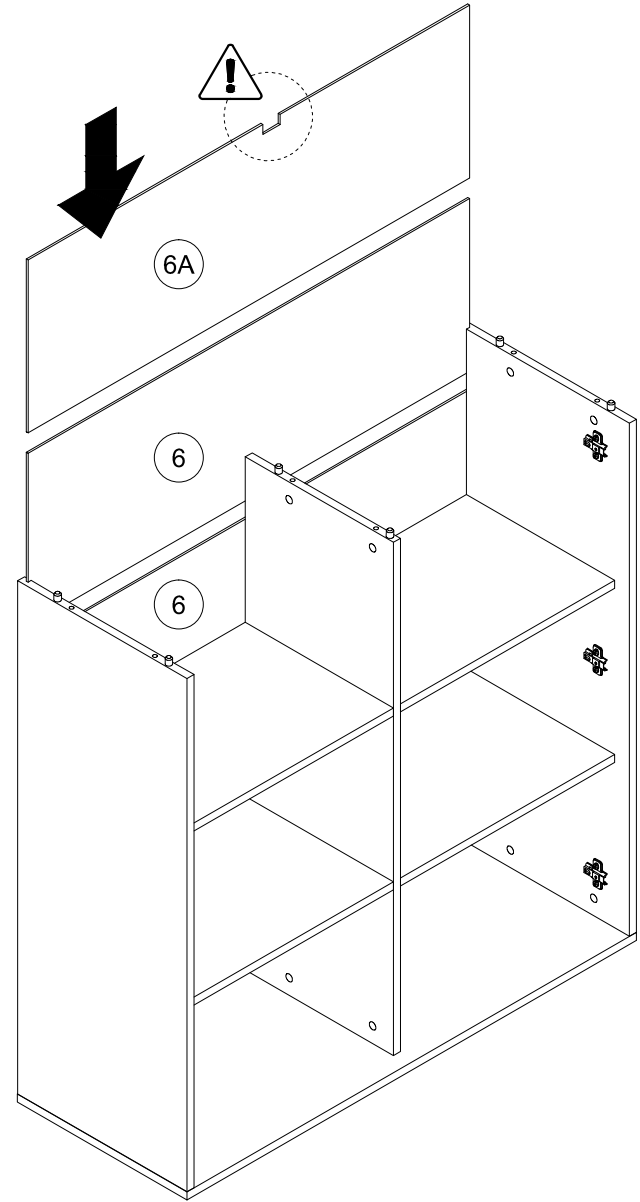

8

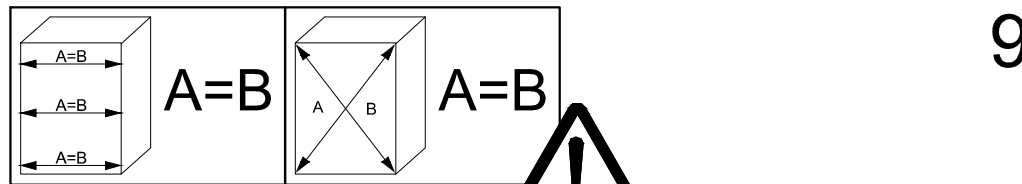
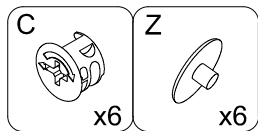
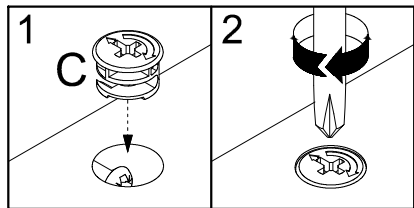
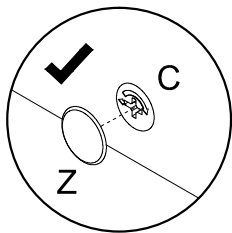
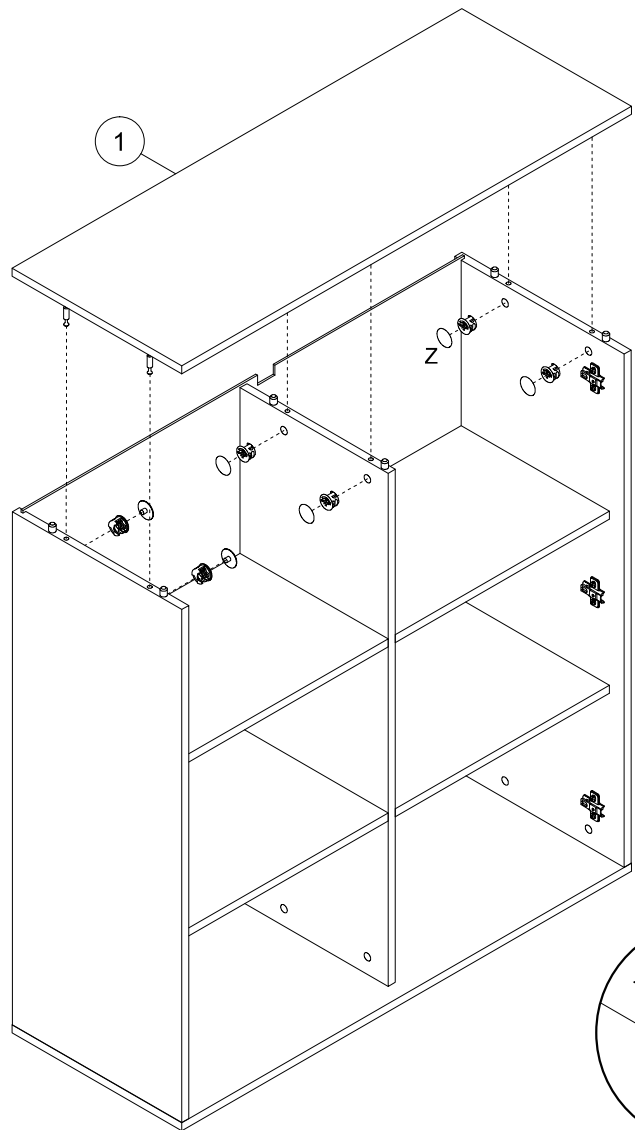

9

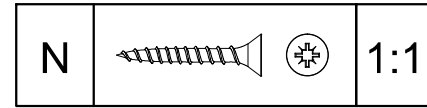
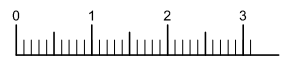
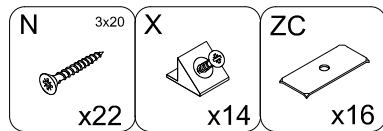
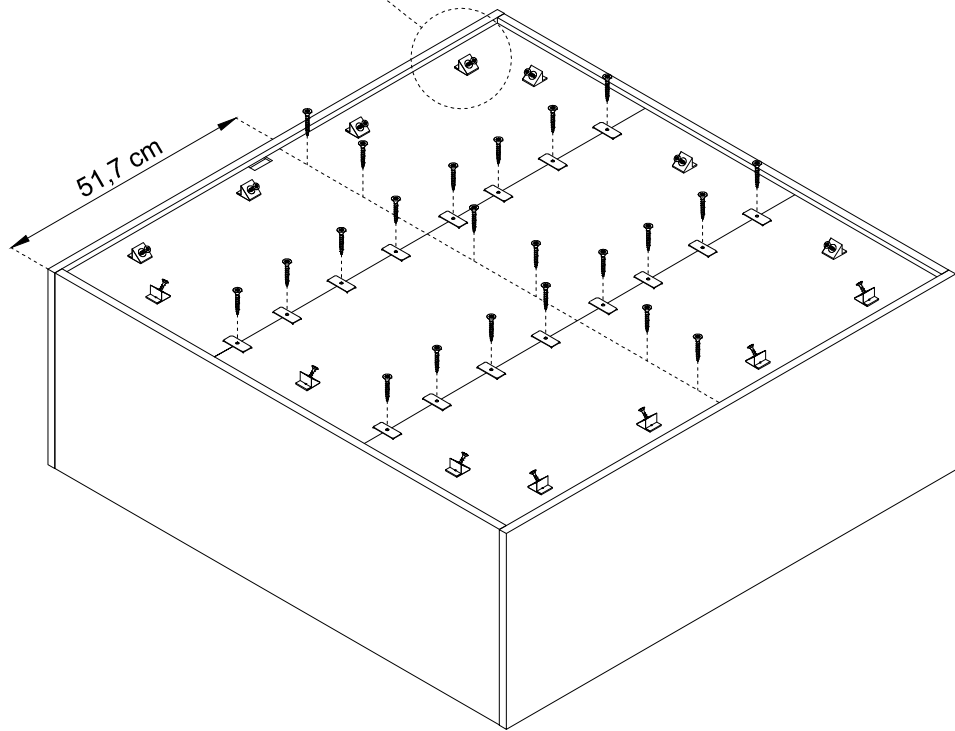
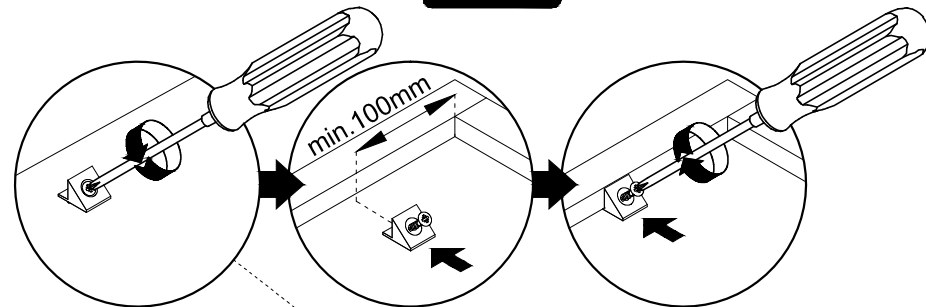

10

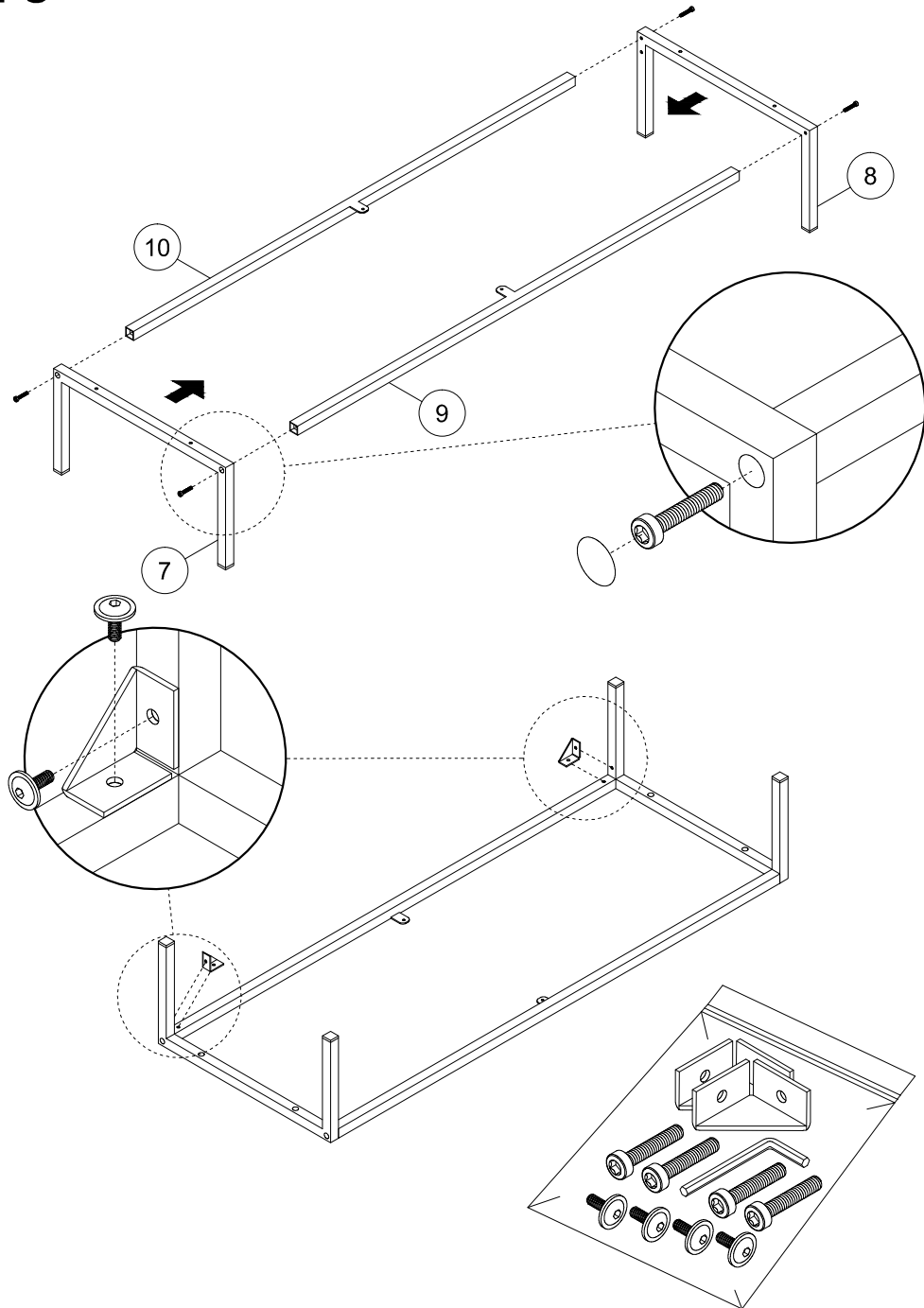

11

