

KAYLA III 200

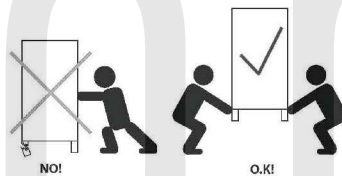
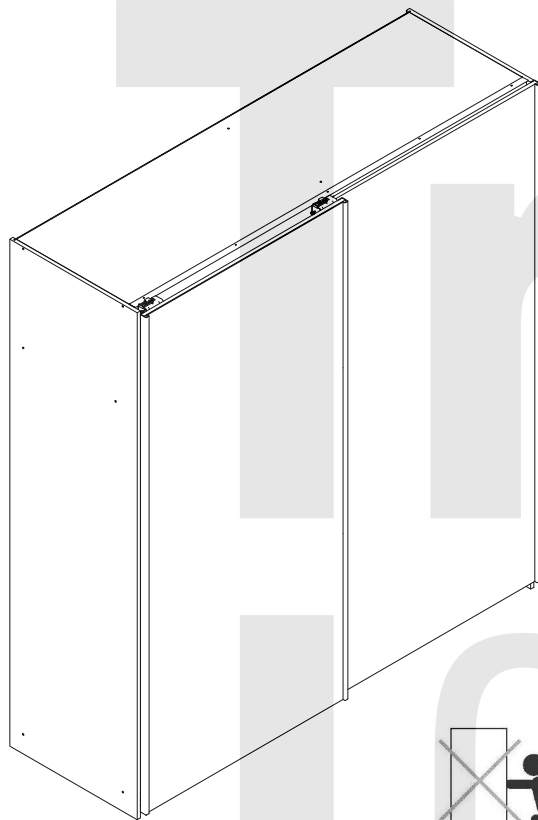

29.03.2017

- (D) Montageanleitung
- (FR) Notice de montage
- (NL) Handleiding voor de montage
- (CZ) Montážní návod
- (HU) Szerelési útmutató
- (TR) Montaj talimati

- (GB) Assembly Instructions
- (IT) Istruzioni di montaggio
- (PL) Instrukcja montażu
- (SK) Návod na montáž
- (RO) Instrucțiuni de montaj
- (RU) Инструкции по монтажу

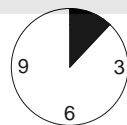
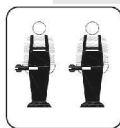





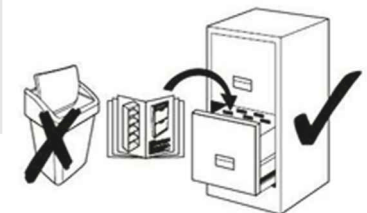
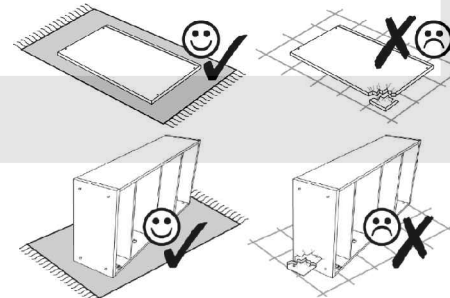
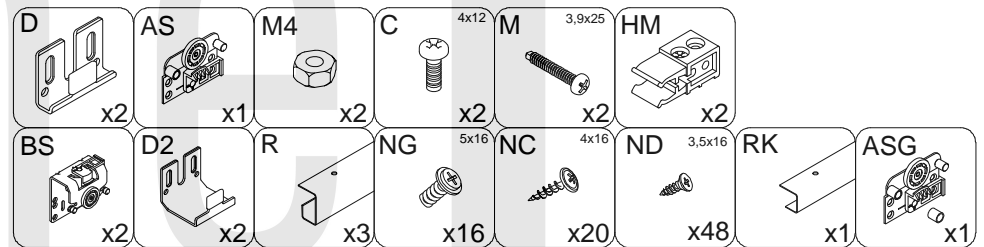
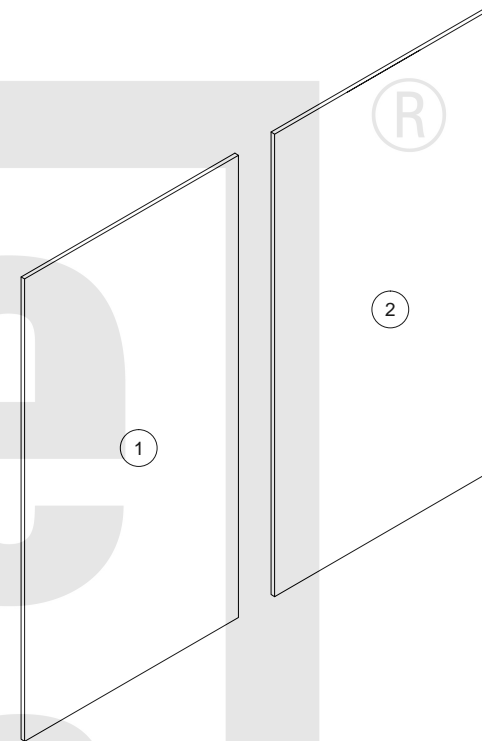

2-2,5

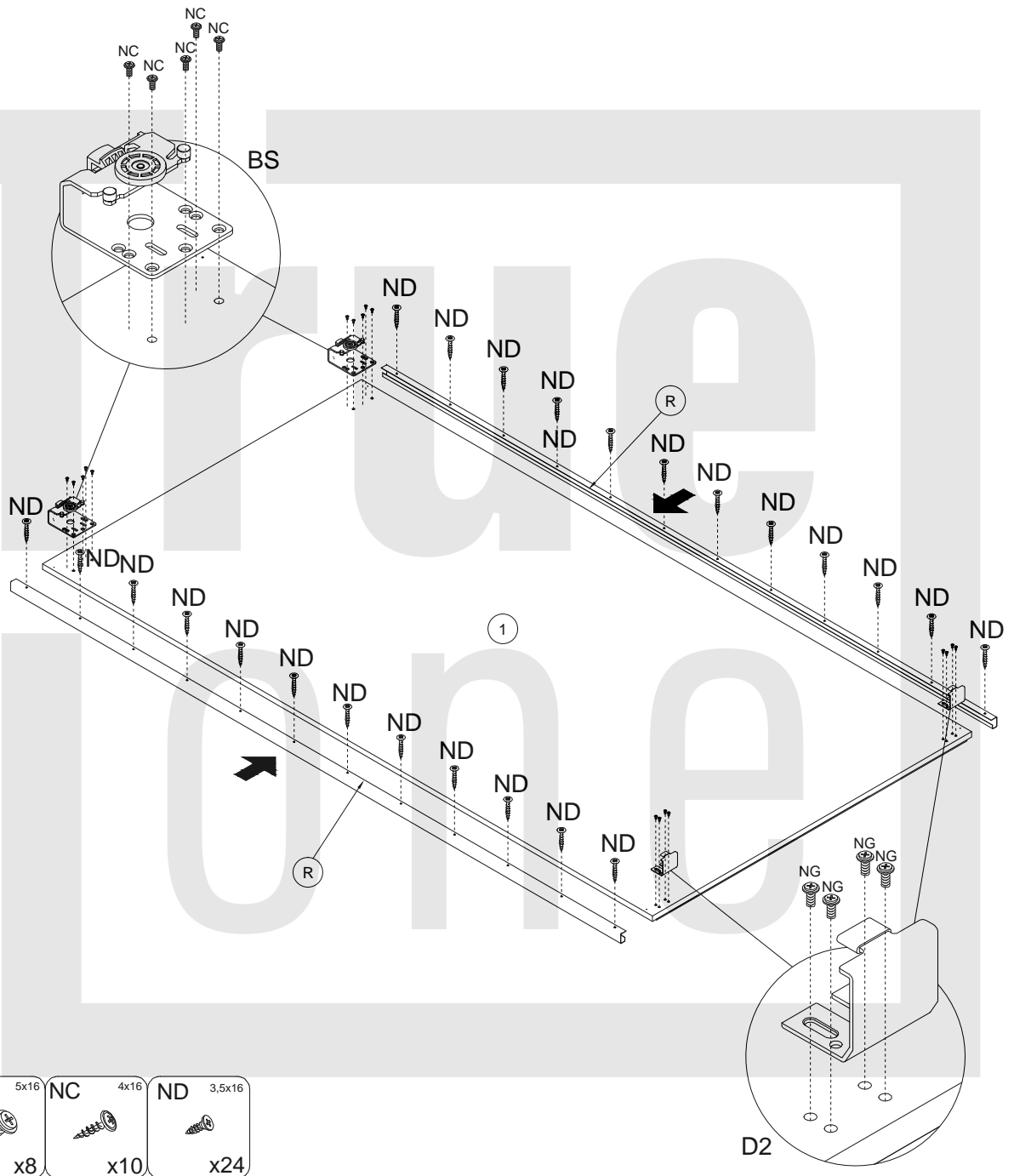
1







2

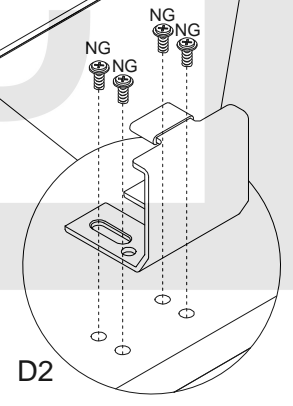

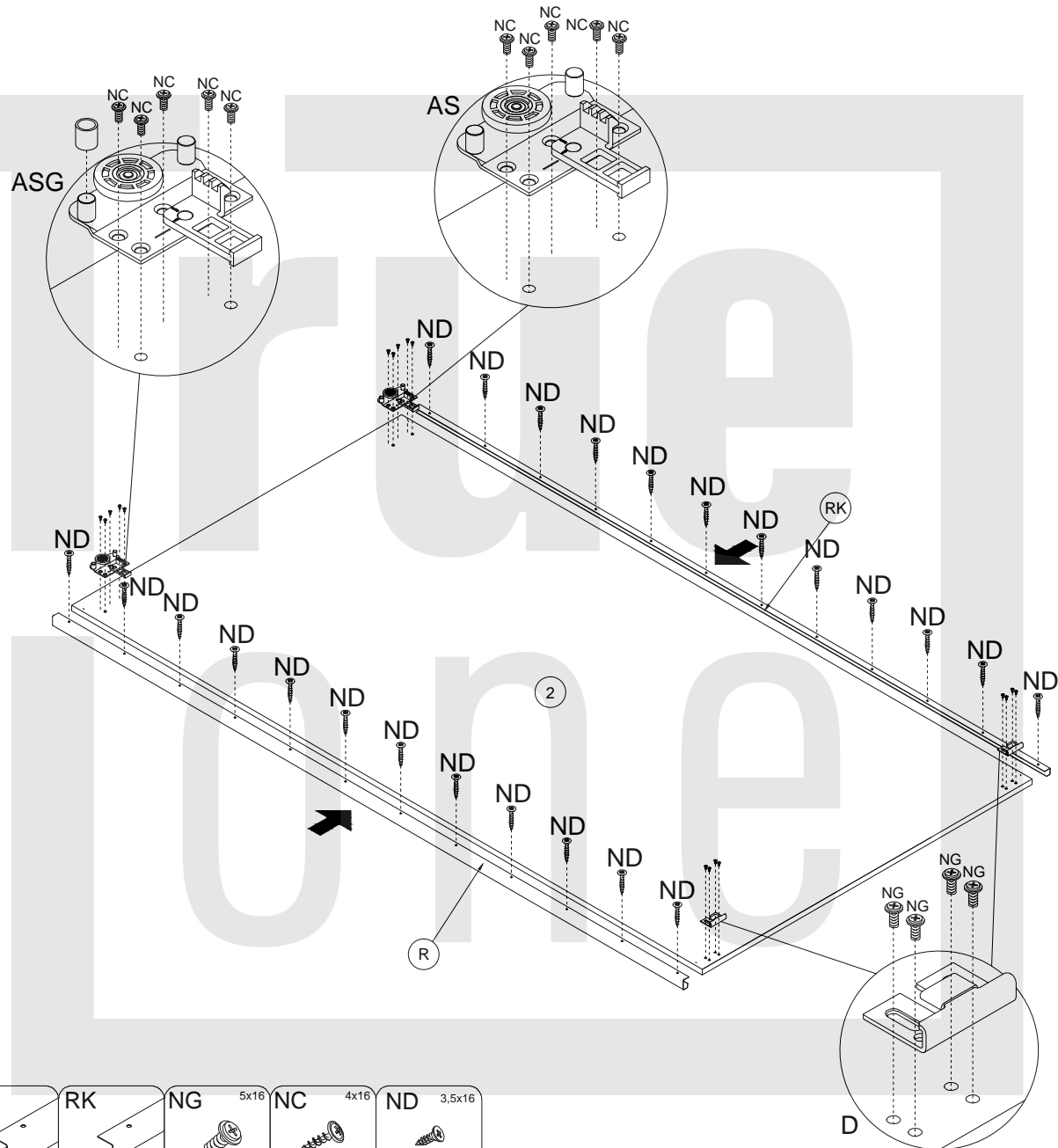
BS  x2	D2  x2	R  x2	NG 5x16  x8	NC 4x16  x10	ND 3,5x16  x24
--	--	---	---	--	--

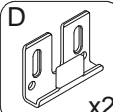
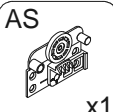

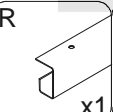
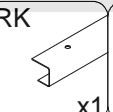

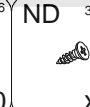
- | | | | | | | | |
|---|---|---|---|---|---|---|--|
|  |  |  |  |  |  |  |  |
| x2 | x1 | x1 | x1 | x1 | 5x16
x8 | 4x16
x10 | 3,5x16
x24 |

