

KAYLA II 200

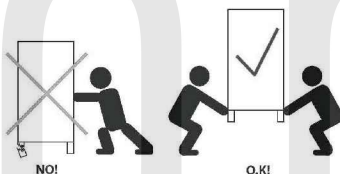
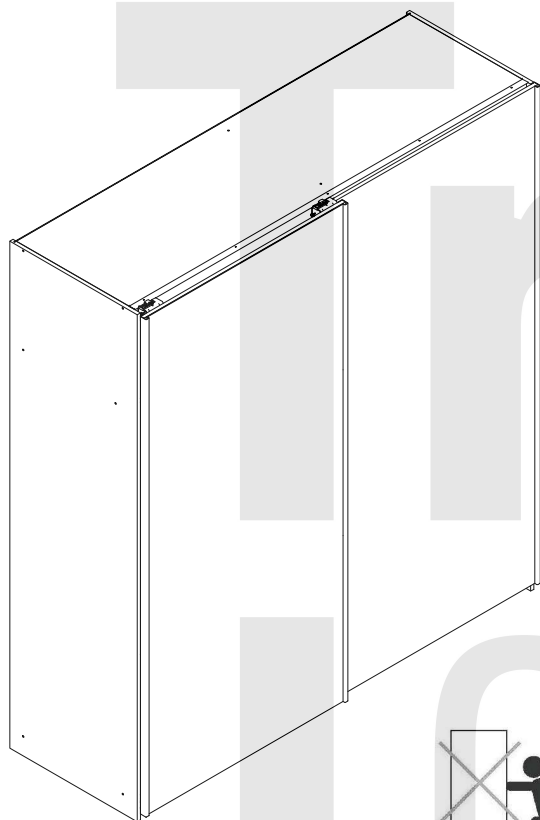

29.03.2017

- (D) Montageanleitung
- (FR) Notice de montage
- (NL) Handleiding voor de montage
- (CZ) Montážní návod
- (HU) Szerelési útmutató
- (TR) Montaj talimati

- (GB) Assembly Instructions
- (IT) Istruzioni di montaggio
- (PL) Instrukcja montażu
- (SK) Návod na montáž
- (RO) Instrucțiuni de montaj
- (RU) Инструкции по монтажу

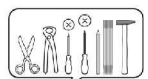





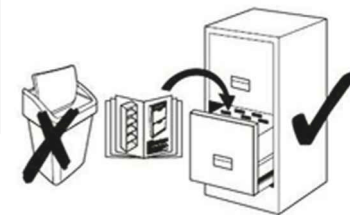
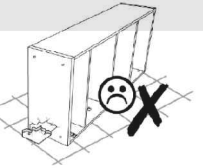
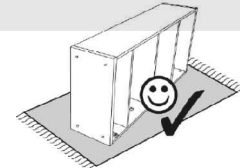
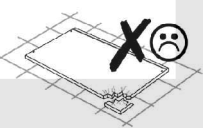
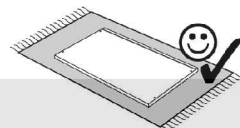
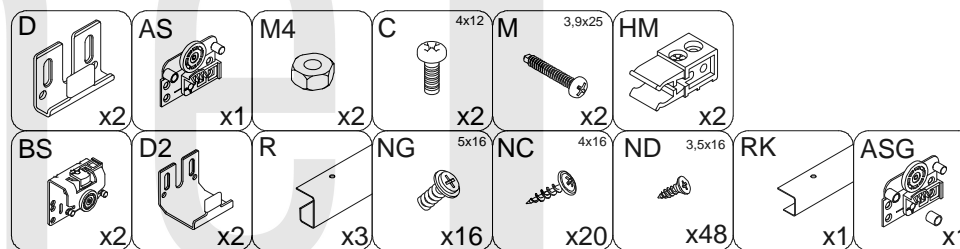
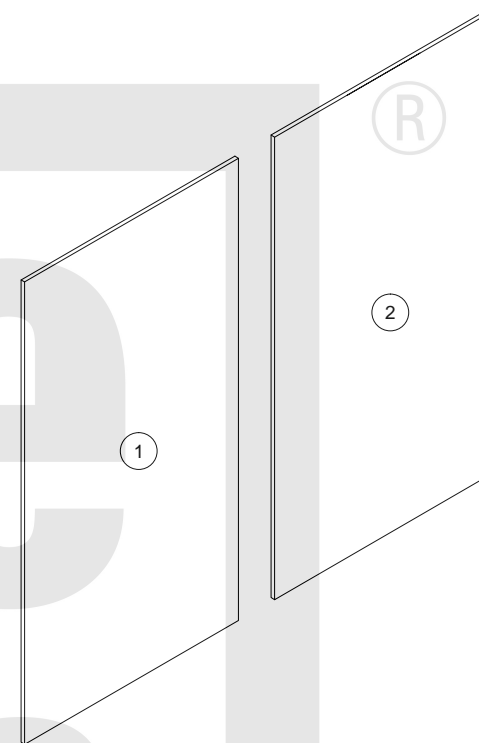

2-2,5

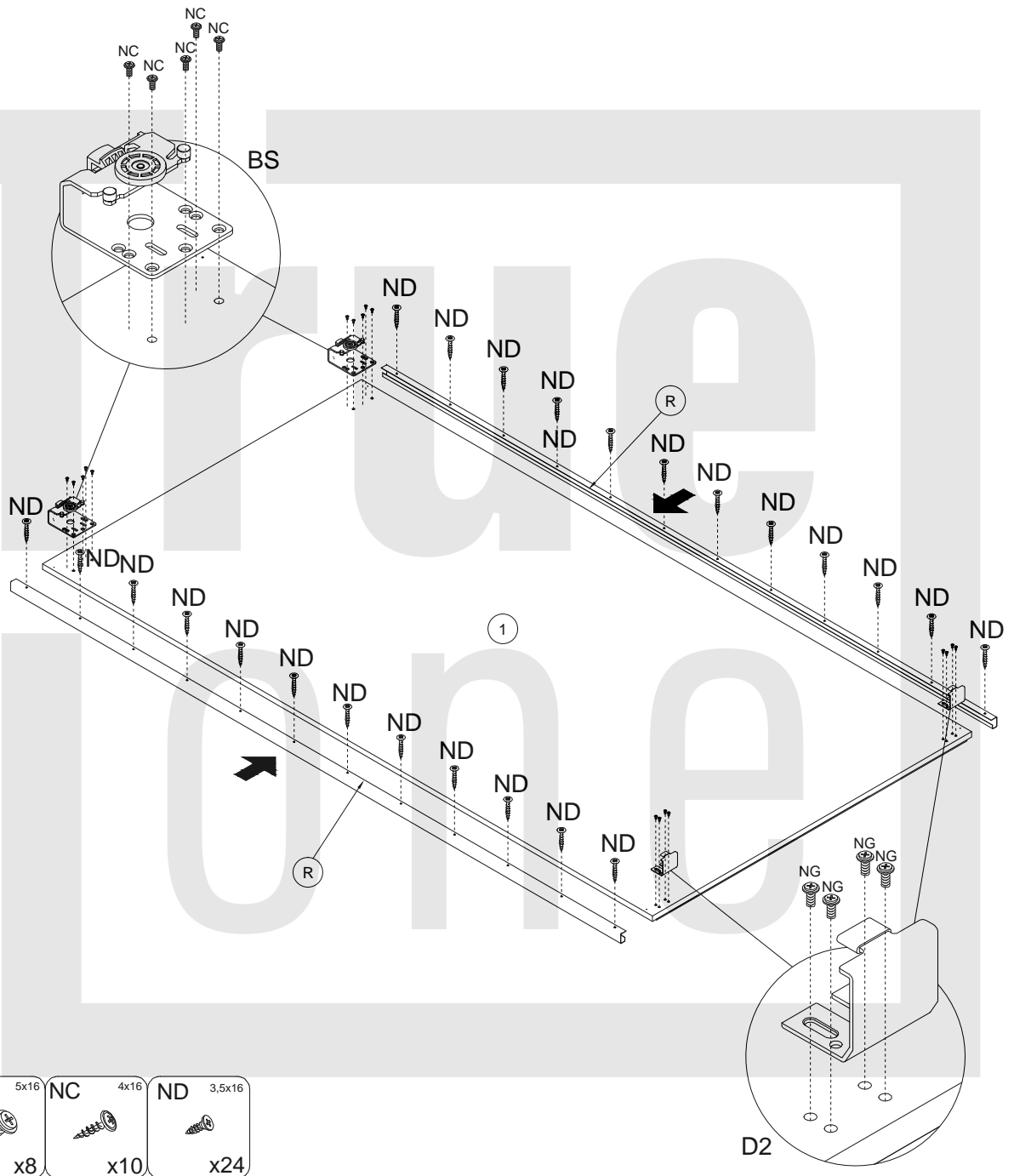
1







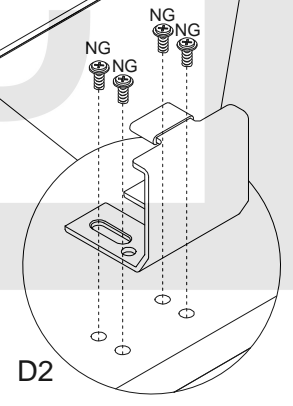

2

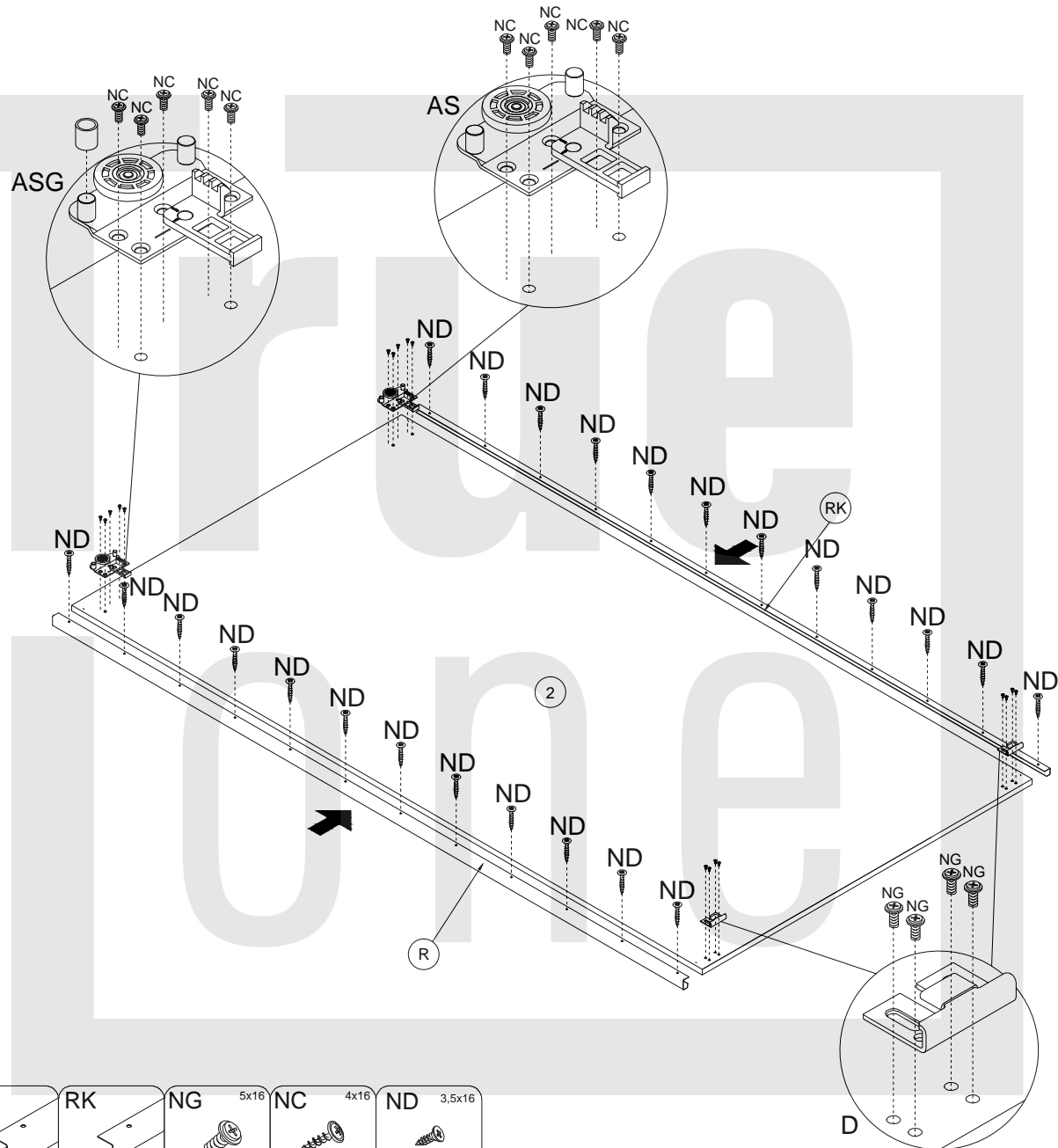

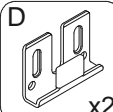
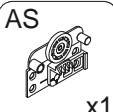
- | | | | | | |
|--|--|---|---|--|--|
| BS

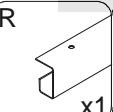
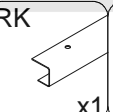
x2 | D2

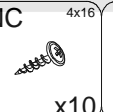
x2 | R

x2 | NG 5x16

x8 | NC 4x16

x10 | ND 3,5x16

x24 |
|--|--|---|---|--|--|





- | | | | | | | | |
|---|--|---|---|--|---|---|--|
|  D |  AS |  ASG |  R |  RK |  NG 5x16 |  NC 4x16 |  ND 3,5x16 |
| x2 | x1 | x1 | x1 | x1 | x8 | x10 | x24 |

