

**Produkt
POLSKI****2 Osoby****Opcje szafki**

Typ:L

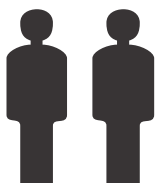
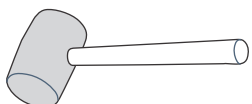
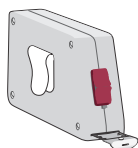
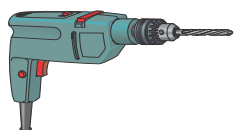
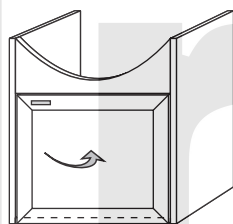
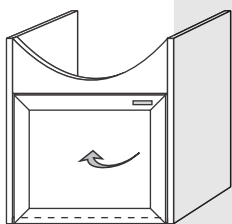
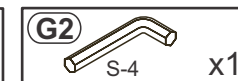
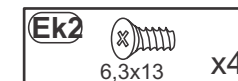
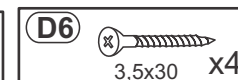
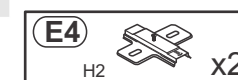
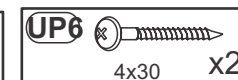
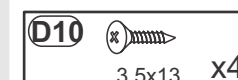
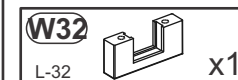
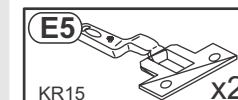
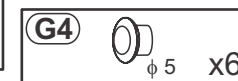
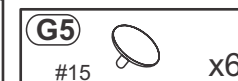
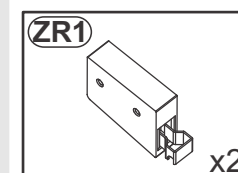
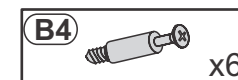
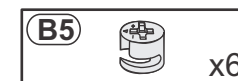
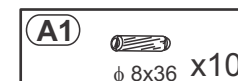
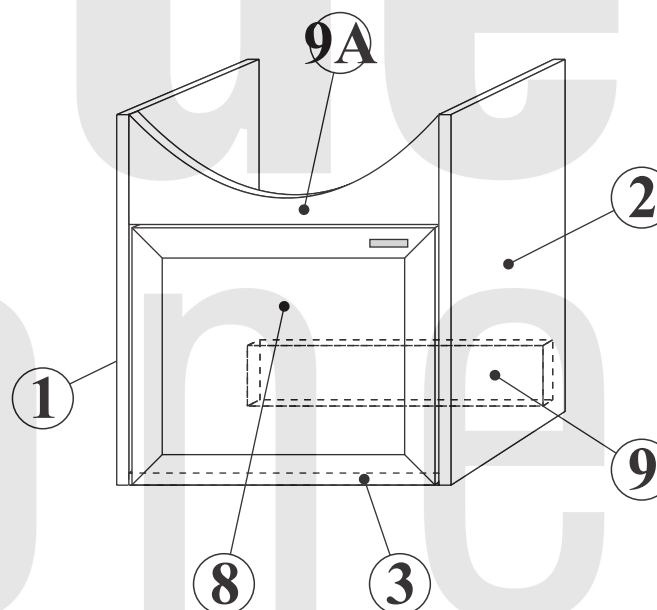

Typ:P

**INSTRUKCJA MONTAŻOWA****Wskazówka dotycząca
pielęgnacji!**

Proszę czyścić tylko suchą
lub lekko wilgotną szmatką do kurzu.
Nie używać żadnych środków szorstkich !

Ostatecznie montujący jest odpowiedzialny za zamocowanie na ścianie i za użyte przy tym materiały (kołki). W razie potrzeby oznacza to, że może być osadzony tylko taki kołek, który jest odpowiedni i konieczny dla danej ściany. Odpowiedni kołek otrzymają Państwo w każdym specjalistycznym sklepie wraz z niezbędną poradą.

1

Typ:L

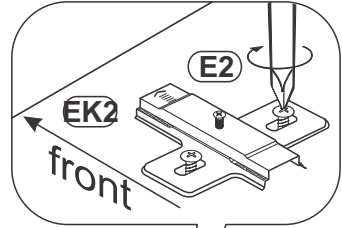

B4

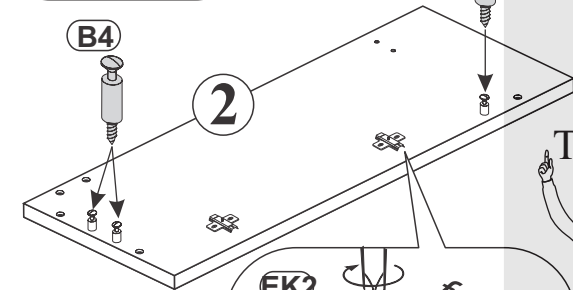
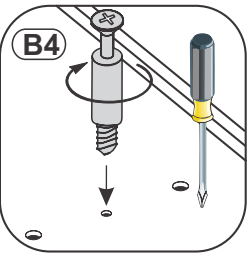
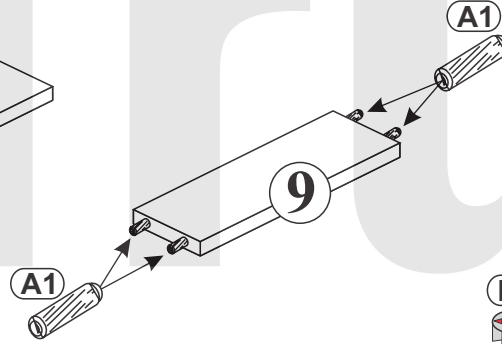
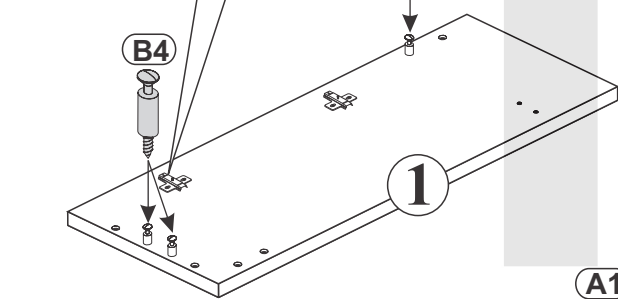
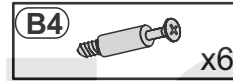
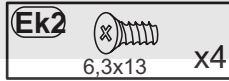
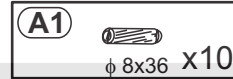
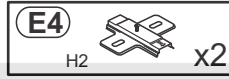
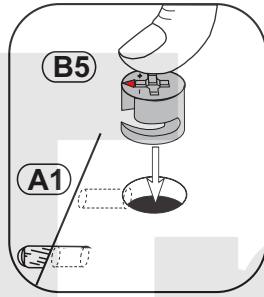

Typ:P

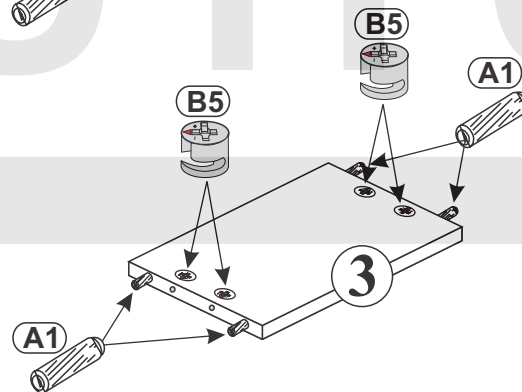
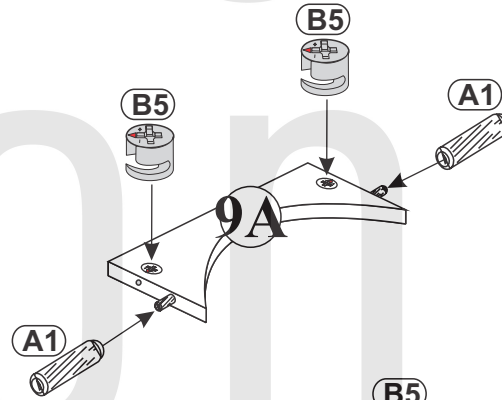
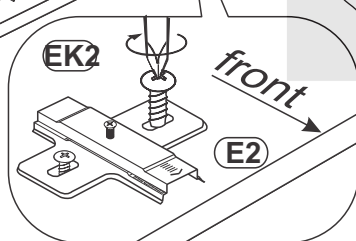

2

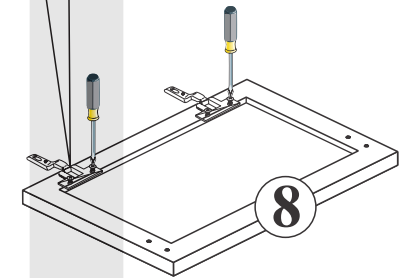
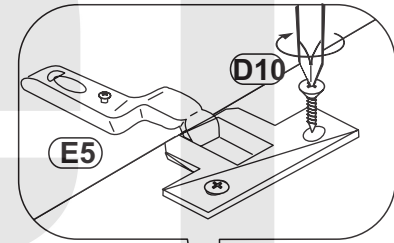
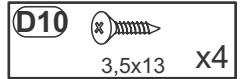
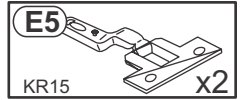

3 Typ:L 

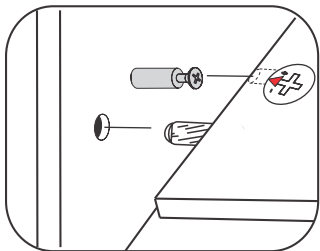
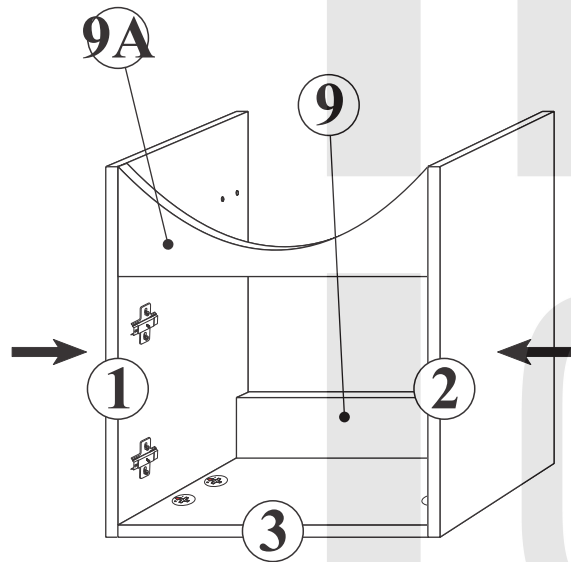
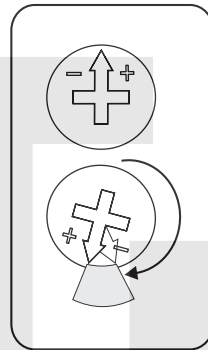

4 Typ:L 

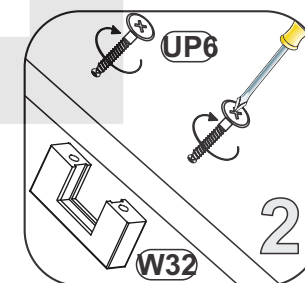
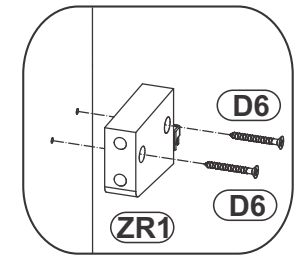
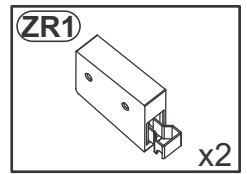
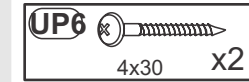
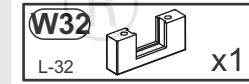
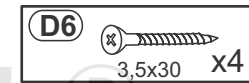
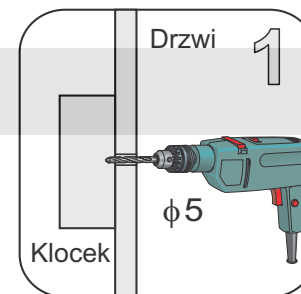
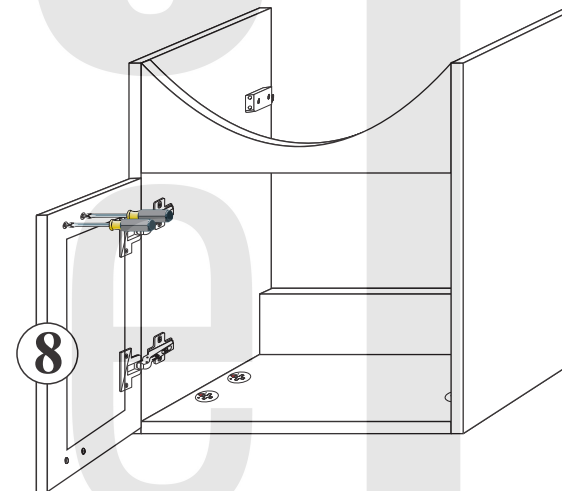
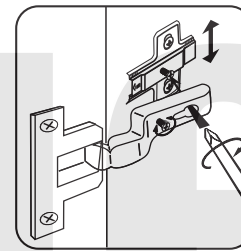

5

G5		x6
#15		

G4		x6
φ 5		

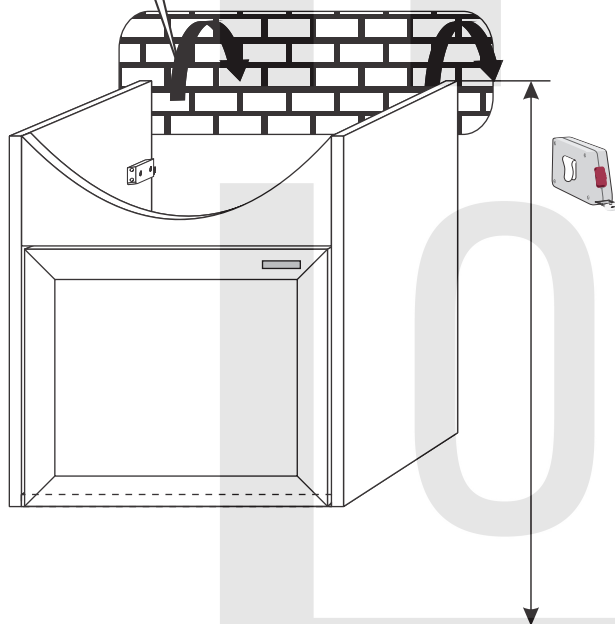
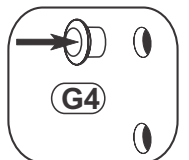
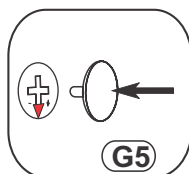
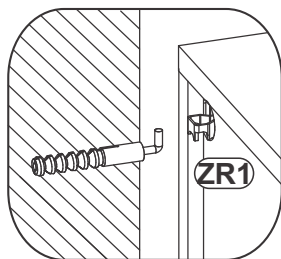

Ostatecznie montujący jest odpowiedzialny za zamocowanie na ścianie i za użyte przy tym materiały (kołki). W razie potrzeby oznacza to, że może być osadzony tylko taki kołek, który jest odpowiedni i konieczny dla danej ściany. Odpowiedni kołek otrzymają Państwo w każdym specjalistycznym sklepie wraz z niezbędną poradą.

Verstellmöglichkeiten

- a) Fugenverstellung:
Befestigungsschraube "A" lockern, gewünschte Fuge mit Schraube "B" einstellen, Schraube "A" anziehen.
- b) Tiefenverstellung:
Befestigungsschraube "A" lockern, Bandarm nach vorne oder rückwärts verschieben, Schraube "A" anziehen, Schraube "B" mit einer 1/4 Drehung nach rechts arretieren.
- c) Höhenverstellung:
Befestigungsschraube "C" lockern, Höhe einstellen, Schraube "C" anziehen.

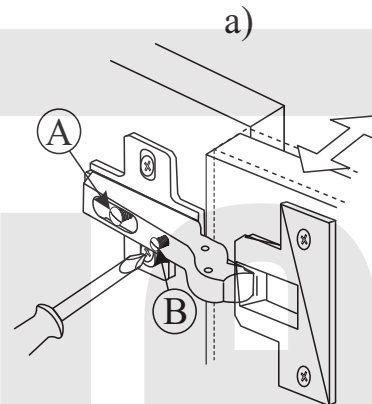

Instructions for hinge adjustment

- a) Side adjustment:
Loosen fixing screw "A", adjust gap with screw "B" and retighten screw "A".
- b) Depth adjustment:
Loosen fixing screw "A", push hinge arm forwards or backwards, retighten screw "A", fix screw "B" with a 1/4-turn in clock-wise direction.
- c) Height adjustment:
Loosen screw "C", adjust height, retighten screw "C".

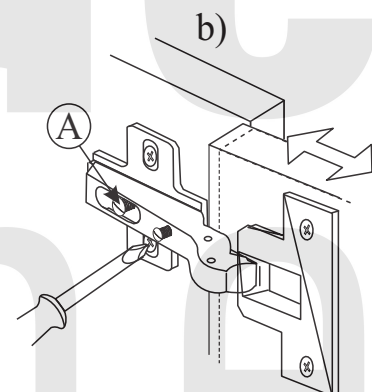

Les possibilités de positionnement

- a) Positionnement de la rainure:
Desserrer la vis de fixation "A", positionner avec la vis "B" la rainure (joint) souhaitée et resserrer la vis "A".
- b) Positionnement de la profondeur:
Desserrer la vis de fixation "A" (1 tour), régler la profondeur et resserrer la vis "A".
- c) Positionnement de la hauteur:
Desserrer la vis de fixation "C" (1 tour), positionner la hauteur et resserrer la vis "C".

Możliwości regulacji

- a) Regulacja szczeliny:
Poluzować wkręt "A", wkrętem "B" ustawić odpowiednią szczelinę, dokręcić wkręt "A".
- b) Regulacja głębokości:
Poluzować wkręt "A" (1 obrót), ustawić głębokość, dokręcić wkręt "A".
- c) Regulacja wysokości:
Poluzować wkręt "C" (1 obrót), dokonać regulacji wysokości położenia drzwi, wkręt "C" dokręcić.

