

**Produkt
POLSKI**

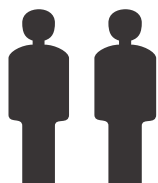

2 Osoby

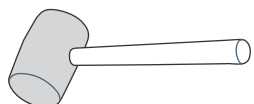
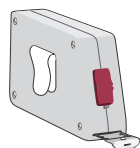
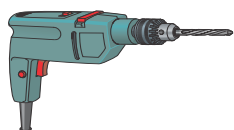

Opcje szafki

Typ:L

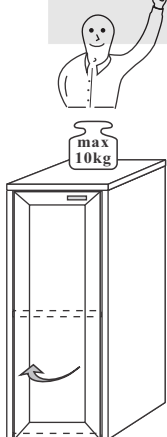

Typ:P

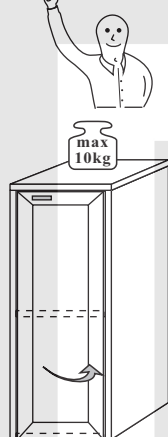

INSTRUKCJA MONTAŻOWA

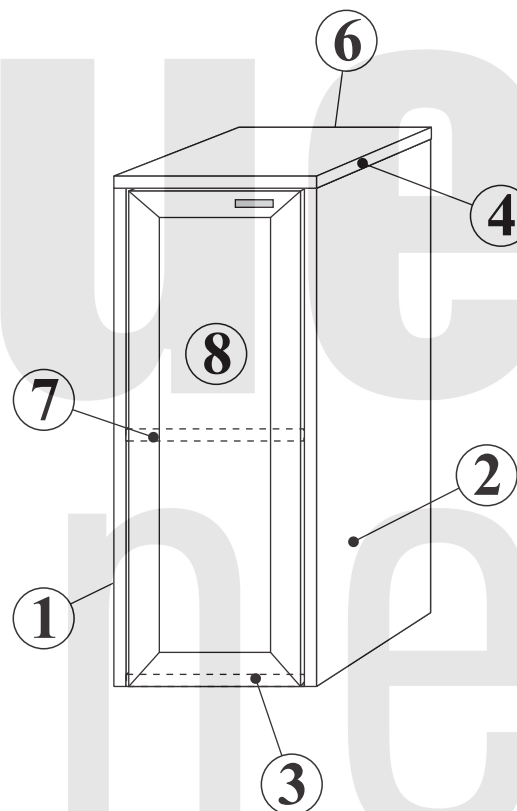

**Wskazówka dotycząca
pielęgnacji!**

Proszę czyścić tylko suchą
lub lekko wilgotną szmatką do kurzu.
Nie używać żadnych środków szorstkich!

Ostatecznie montujący jest odpowiedzialny za zamocowanie na ścianie i za użyte przy tym materiały (kołki). W razie potrzeby oznacza to, że może być osadzony tylko taki kołek, który jest odpowiedni i konieczny dla danej ściany. Odpowiedni kołek otrzymają Państwo w każdym specjalistycznym sklepie wraz z niezbędną poradą.

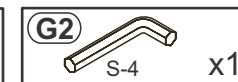
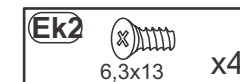
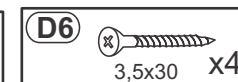
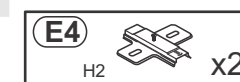
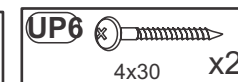
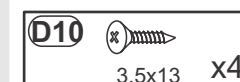
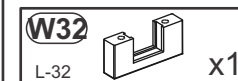
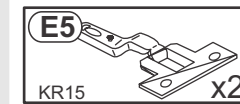
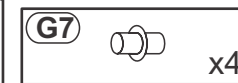
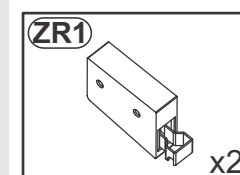
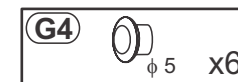
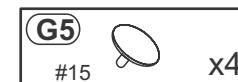
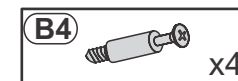
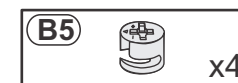
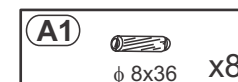

1

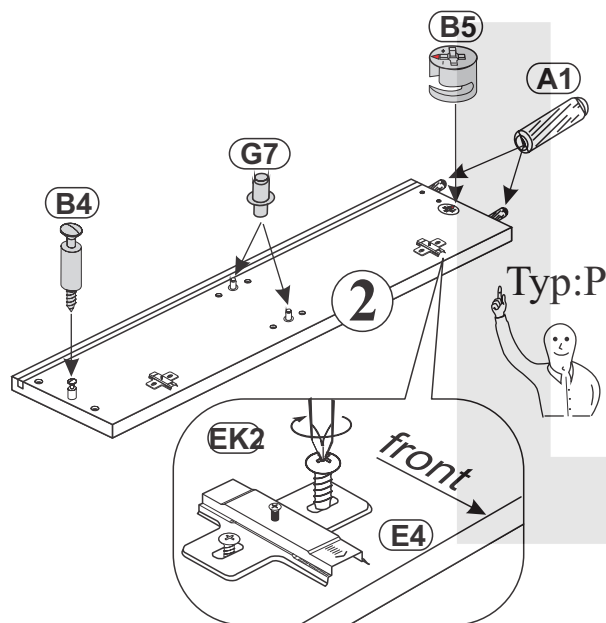
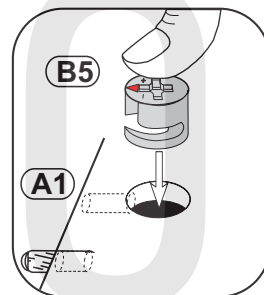
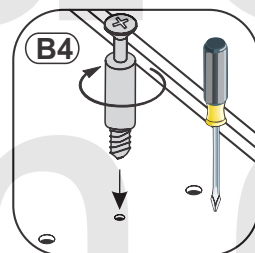
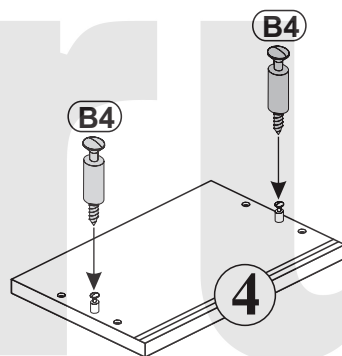
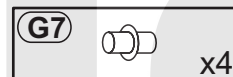
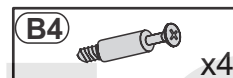
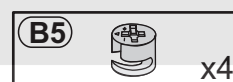
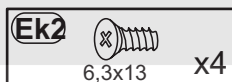
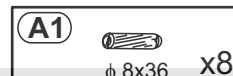
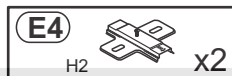
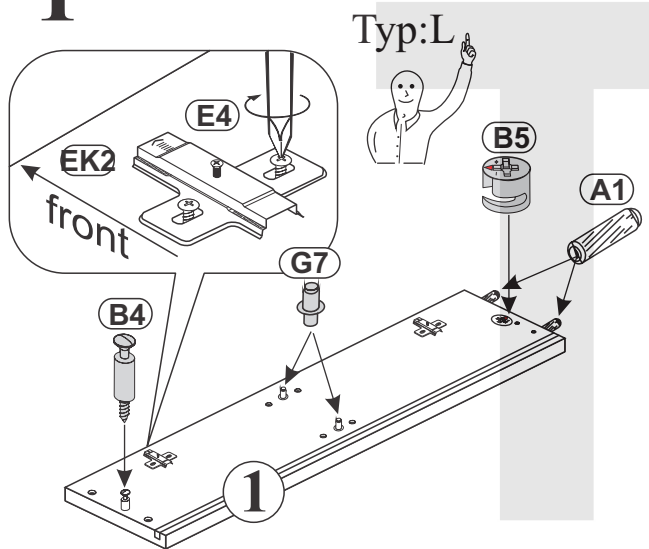

2

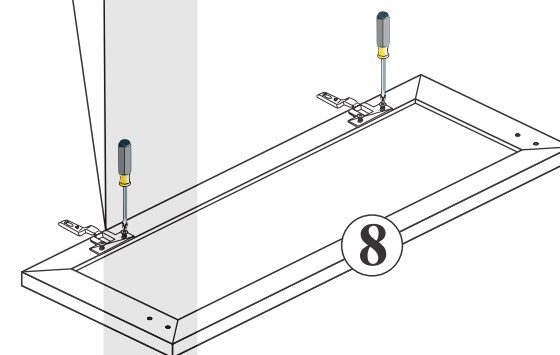
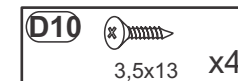
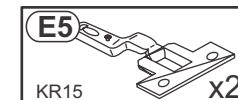
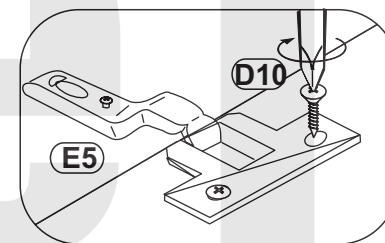

3 Typ:L

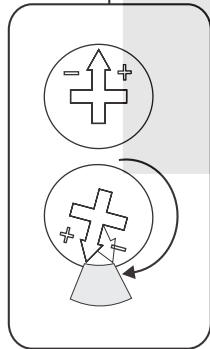
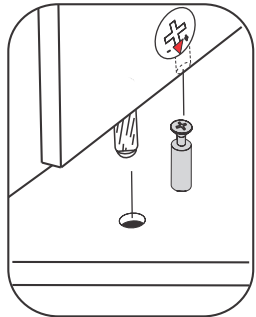
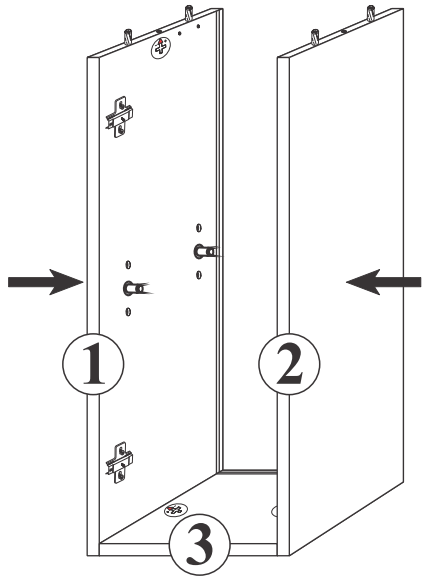

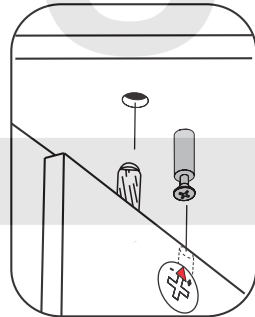
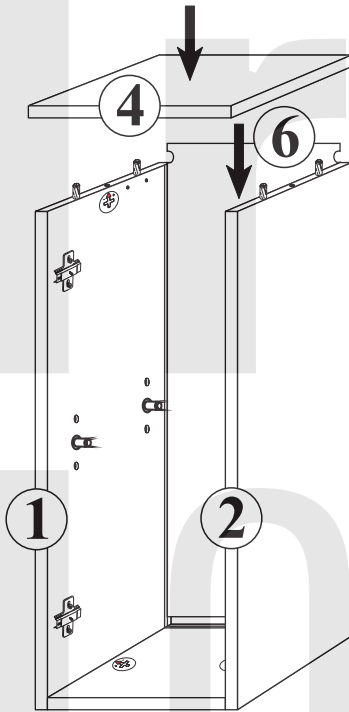

4 Typ:L



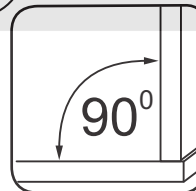
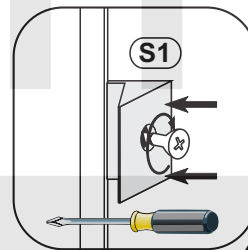
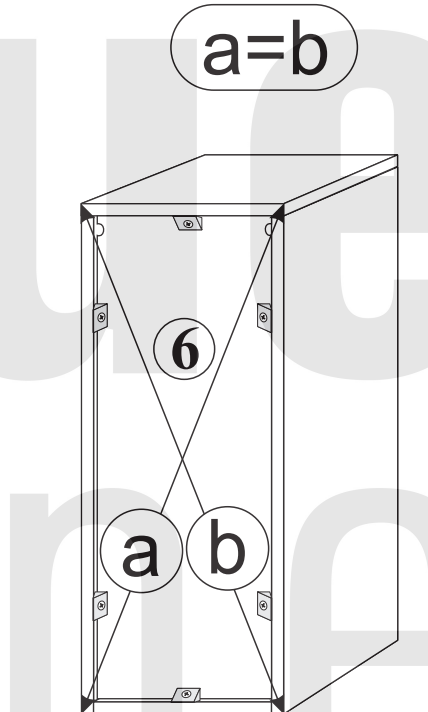

5 **S1**  x6

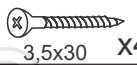

6 Typ:L

D6  3,5x30 x4

W32  L-32 x1

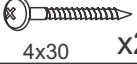
UP6  4x30 x2

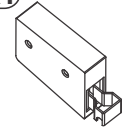
ZR1  x2

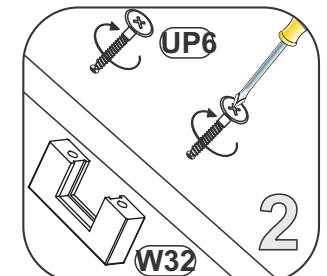
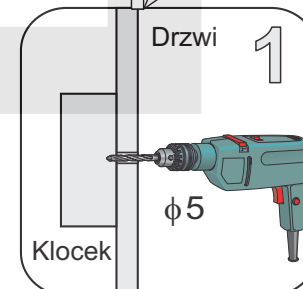
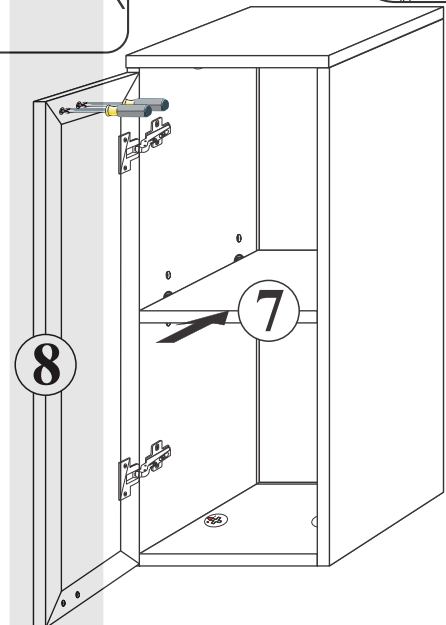
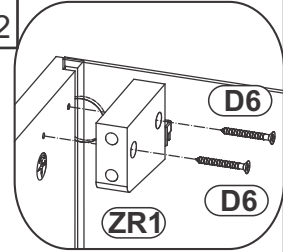
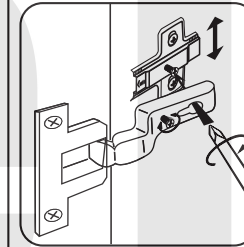

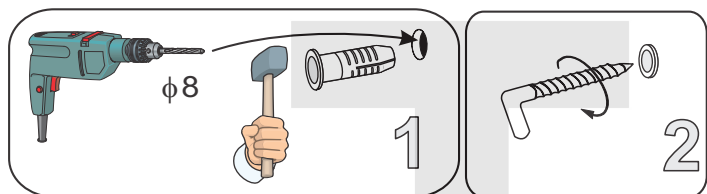
7

| | | | |
|-----------|--|-----|----|
| G5 | | #15 | x4 |
|-----------|--|-----|----|

| | | | |
|-----------|--|-----|----|
| G4 | | φ 5 | x6 |
|-----------|--|-----|----|

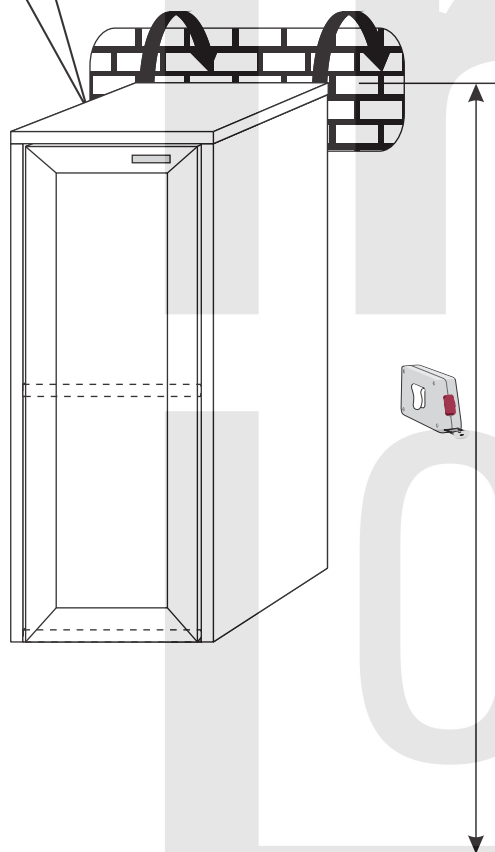
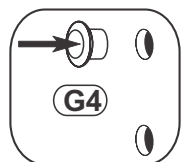
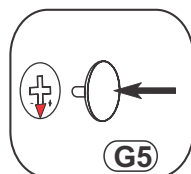
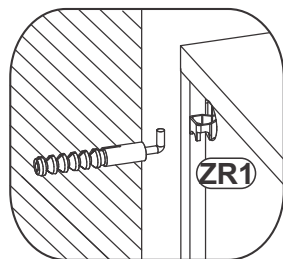

Ostatecznie montujący jest odpowiedzialny za zamocowanie na ścianie i za użyte przy tym materiały (kołki). W razie potrzeby oznacza to, że może być osadzony tylko taki kołek, który jest odpowiedni i konieczny dla danej ściany. Odpowiedni kołek otrzymają Państwo w każdym specjalistycznym sklepie wraz z niezbędną poradą.

Verstellmöglichkeiten

a) Fugenverstellung:
Befestigungsschraube "A" lockern, gewünschte Fuge mit Schraube "B" einstellen, Schraube "A" anziehen.

b) Tiefenverstellung:
Befestigungsschraube "A" lockern, Bandarm nach vorne oder rückwärts verschieben, Schraube "A" anziehen, Schraube "B" mit einer 1/4 Drehung nach rechts arretieren.

c) Höhenverstellung:
Befestigungsschraube "C" lockern, Höhe einstellen, Schraube "C" anziehen.

Instructions for hinge adjustment

a) Side adjustment:
Loosen fixing screw "A", adjust gap with screw "B" and retighten screw "A".

b) Depth adjustment:
Loosen fixing screw "A", push hinge arm forwards or backwards, retighten screw "A", fix screw "B" with a 1/4-turn in clockwise direction.

c) Height adjustment:
Loosen screw "C", adjust height, retighten screw "C".

Les possibilités de positionnement

a) Positionnement de la rainure:
Desserrer la vis de fixation "A", positionner avec la vis "B" la rainure (joint) souhaitée et resserrer la vis "A".

b) Positionnement de la profondeur:
Desserrer la vis de fixation "A" (1 tour), régler la profondeur et resserrer la vis "A".

c) Positionnement de la hauteur:
Desserrer la vis de fixation "C" (1 tour), positionner la hauteur et resserrer la vis "C".

Możliwości regulacji

a) Regulacja szczeliny:
Poluzować wkręt "A", wkrętem "B" ustawić odpowiednią szczelinę, dokręcić wkręt "A".

b) Regulacja głębokości:
Poluzować wkręt "A" (1 obrót), ustawić głębokość, dokręcić wkręt "A".

c) Regulacja wysokości:
Poluzować wkręt "C" (1 obrót), dokonać regulacji wysokości położenia drzwi, wkręt "C" dokręcić.

