

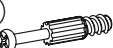











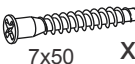

- B1**  ϕ 8x28 x12
- T1**  x8
- M1**  x8
- C2**  ϕ 20 x12
- W1**  x24
- K1**  7x50 x4
- J23**  x10
- F1**  x10
- P2**  3x16 x10

- Z1c**  x6
- S9**  4x16 x12
- D9**  x6

- T30**  x2
- T31**  x2
- S12**  4x30 x8
- F33**  x4
- T17**  ϕ 8x50 5x60 x8

Nr	Ausmaß			St
2	720	160	16	1
3	720	160	16	1
4	718	386	20	3
5	676	120	16	1
6	676	120	16	1
7	373	115	16	4
8	390	115	16	2
9	1168	141	16	2
10	690	387	2	1
11	690	387	2	1
12	690	406	2	1

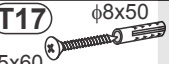
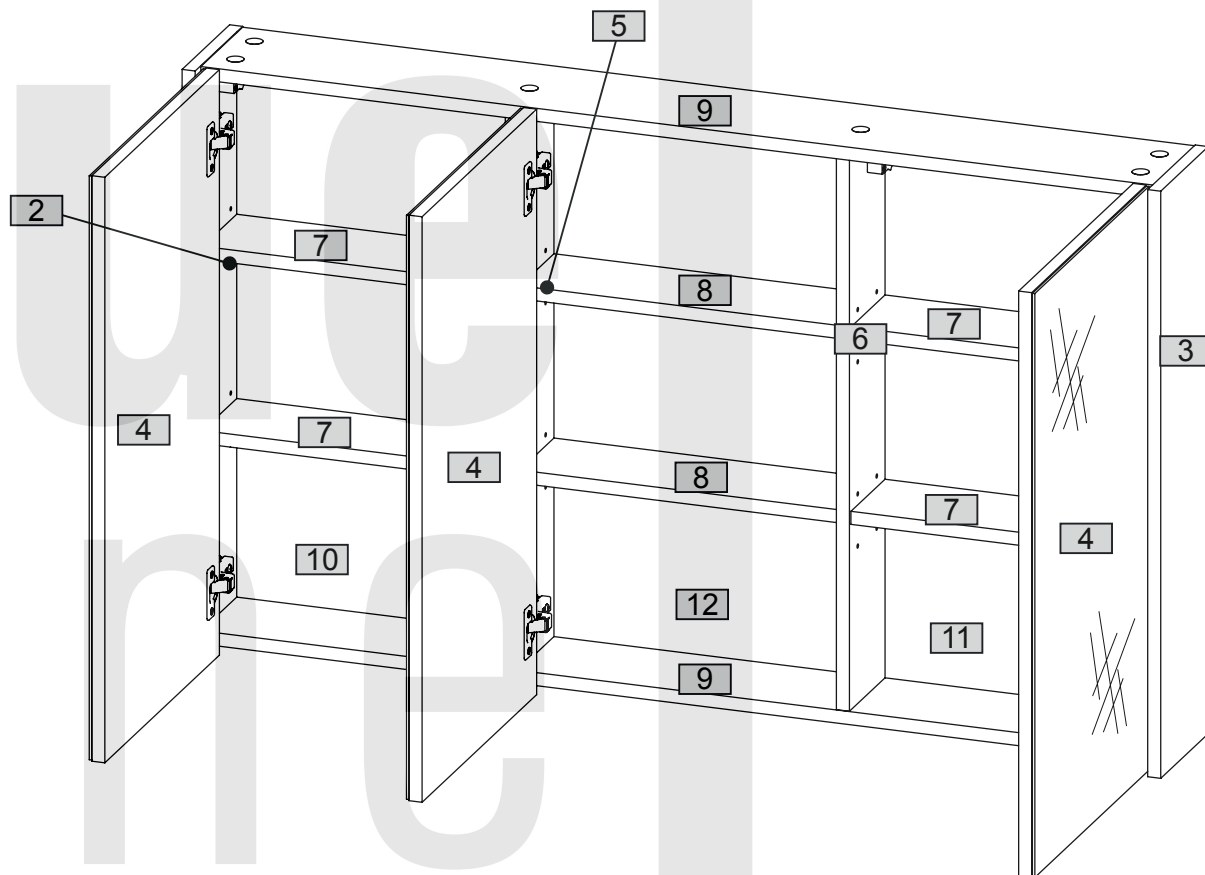

1

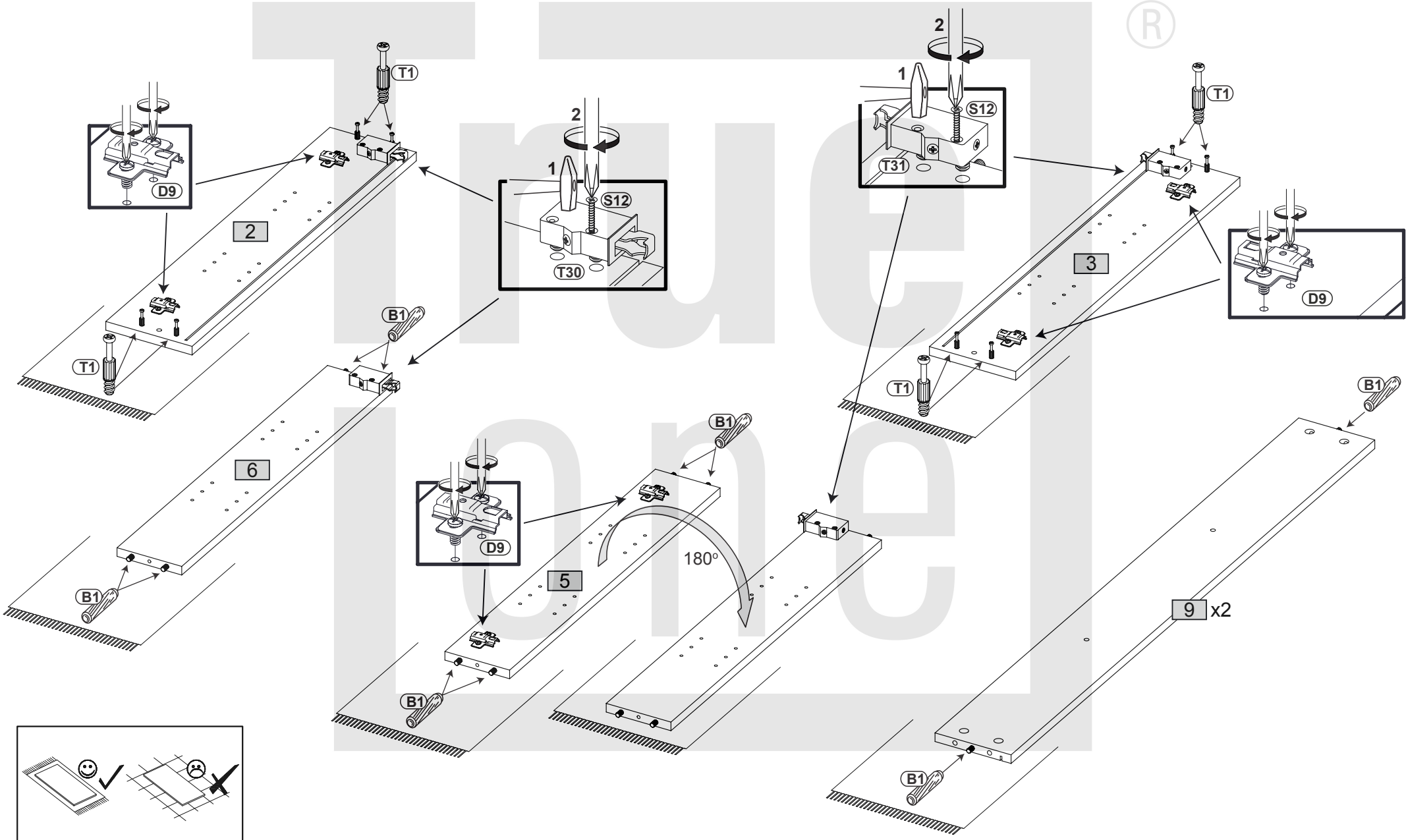
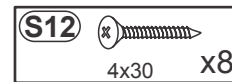
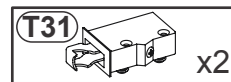
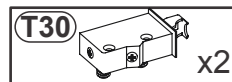
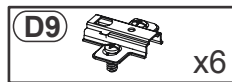
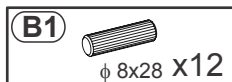
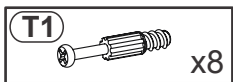

2

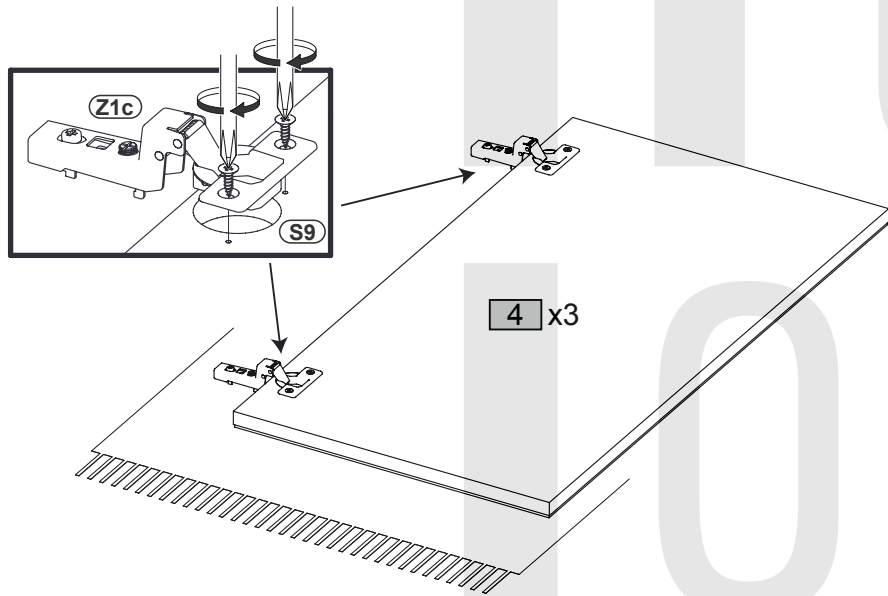
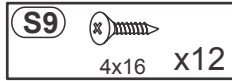
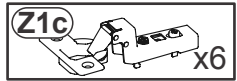

3

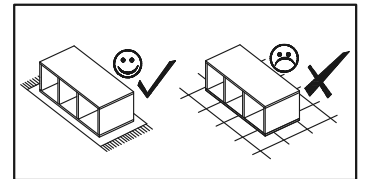
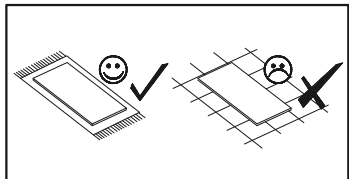
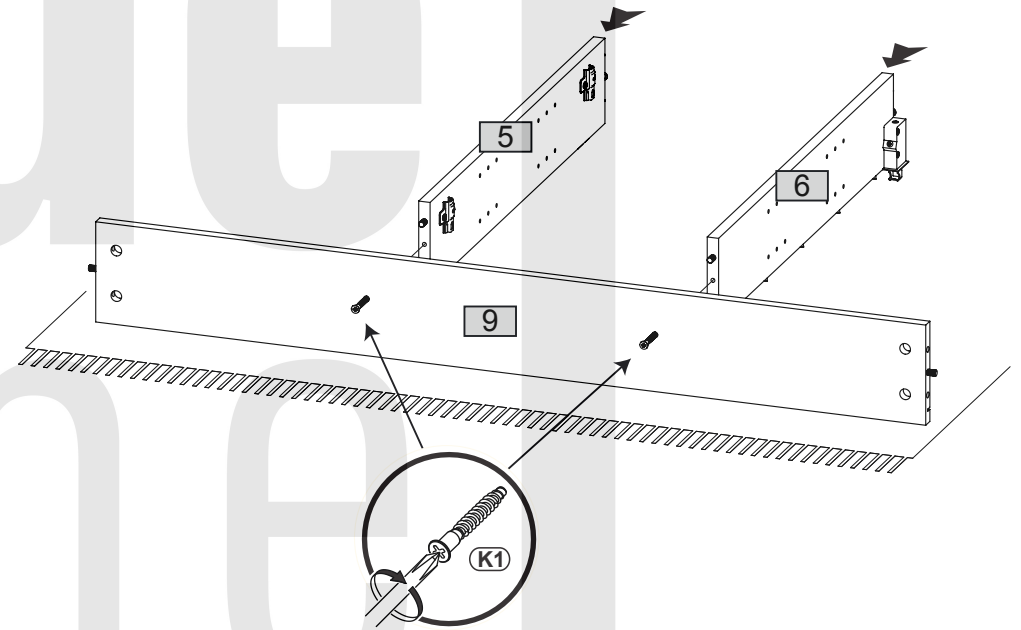
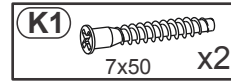

4

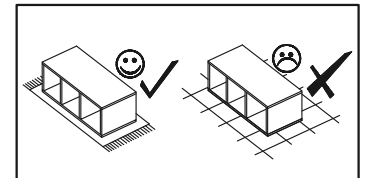
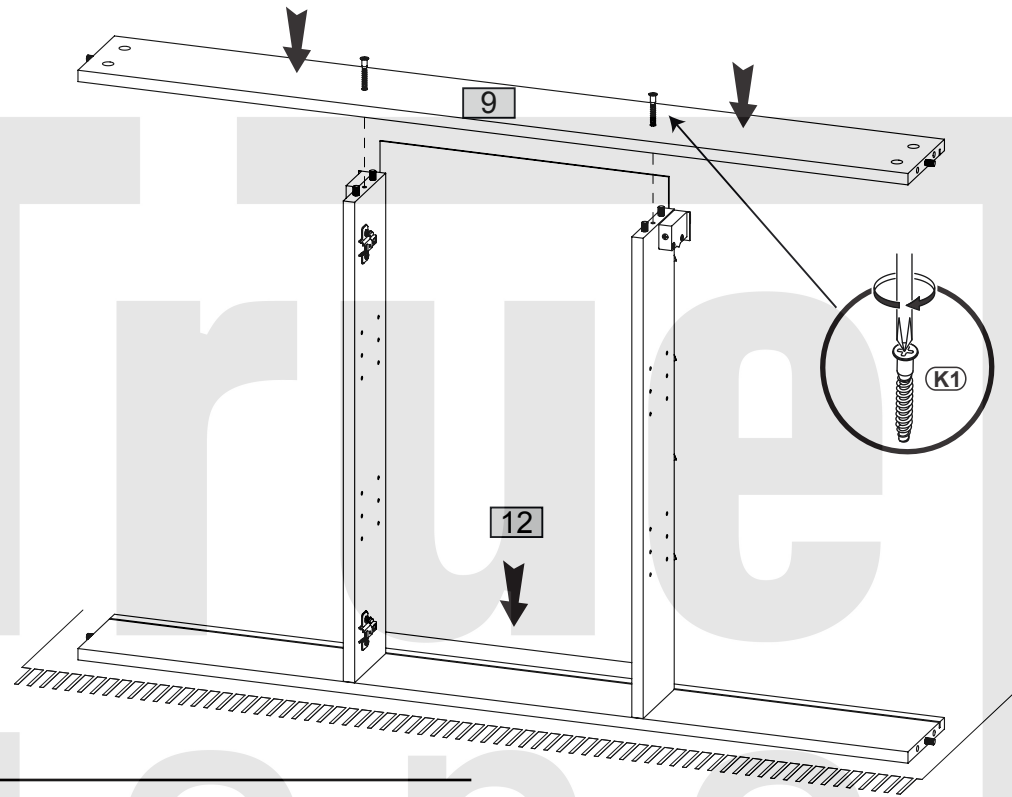
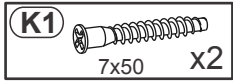

5

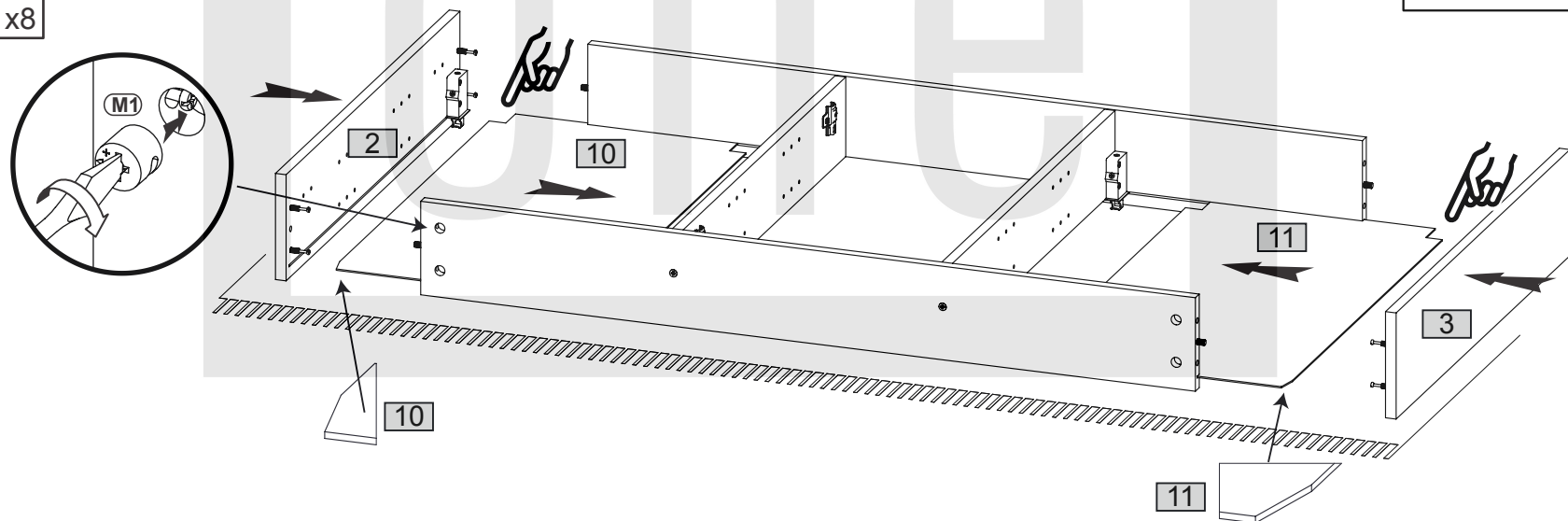

6

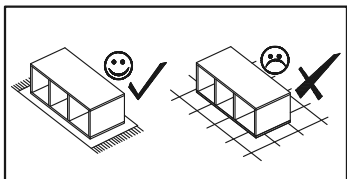
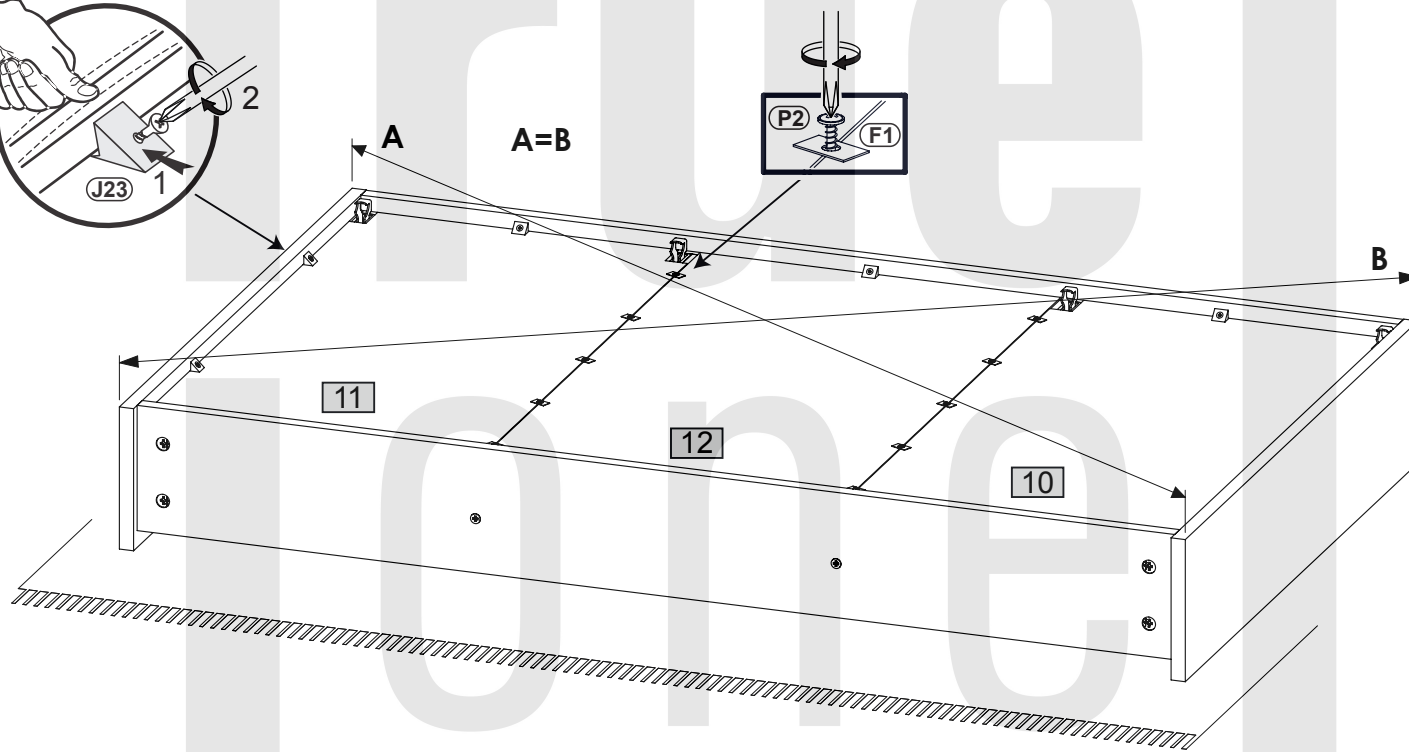
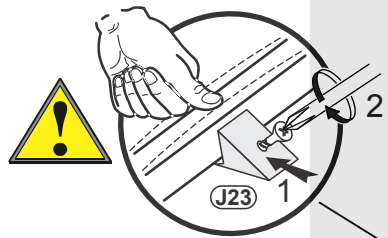
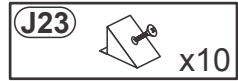
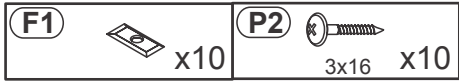

7

F33  x4

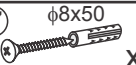
T17 $\phi 8 \times 50$
5x60  x8

W1  x24

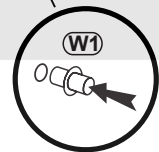
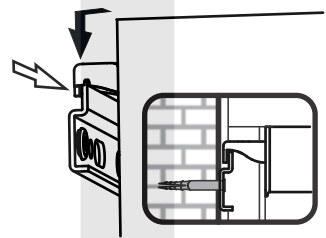
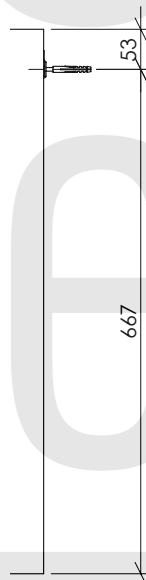
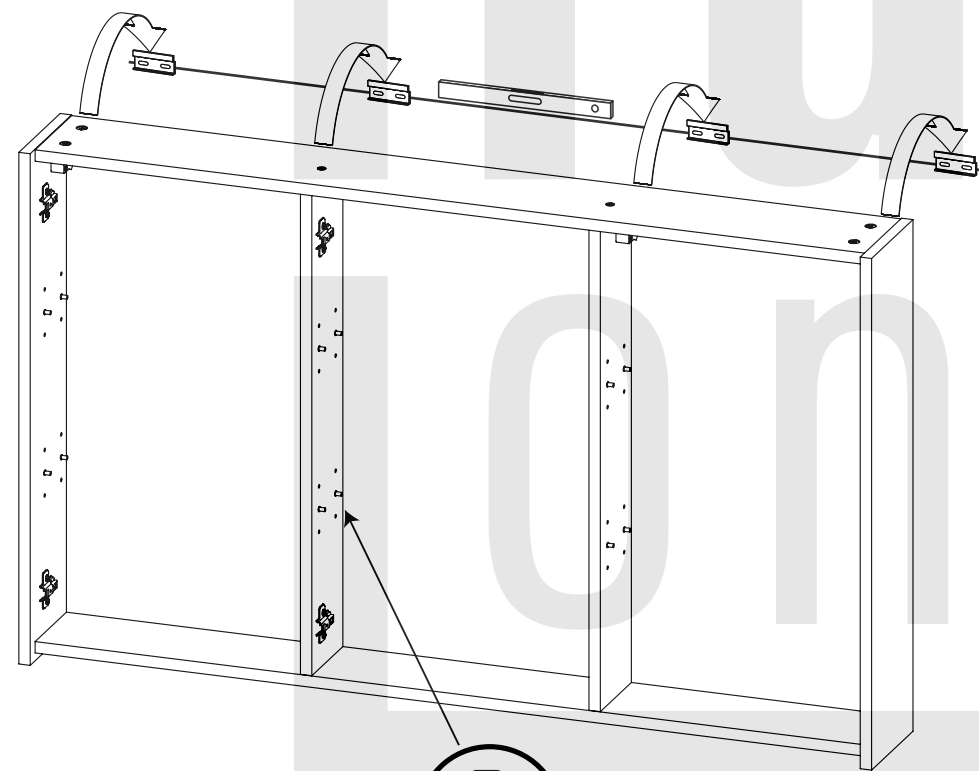
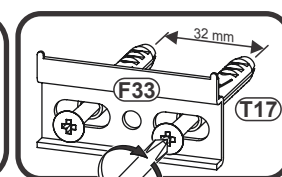
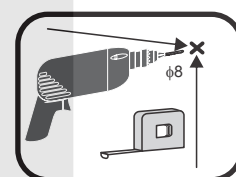
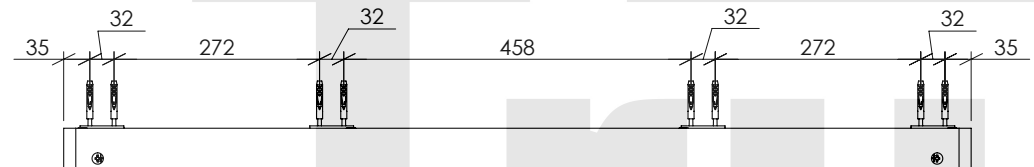
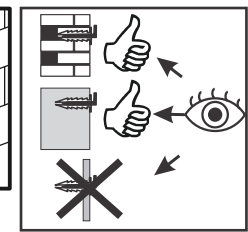
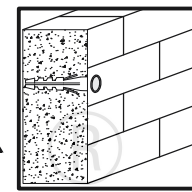

8

C2
φ 20 0 x12

