

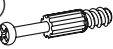











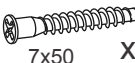



B1		φ 8x28 x12
T1		x8
M1		x8
C2		φ 20 x12
W1		x24
K1		7x50 x4
J23		x10
F1		x10
P2		3x16 x10

Z3c		x6
S9		4x16 x12
D9		x6
T30		x1
T31		x1
S12		4x30 x4
F33		x2
T17		φ8x50 5x60 x4

Nr	Ausmaß			St
3	720	160	16	1
4	720	160	16	1
5	718	386	20	1
6	718	186	20	2
7	676	120	16	1
8	676	120	16	1
9	181	115	16	4
10	373	115	16	2
11	768	141	16	2
12	690	195	2	1
13	690	195	2	1
14	690	390	2	1

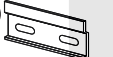

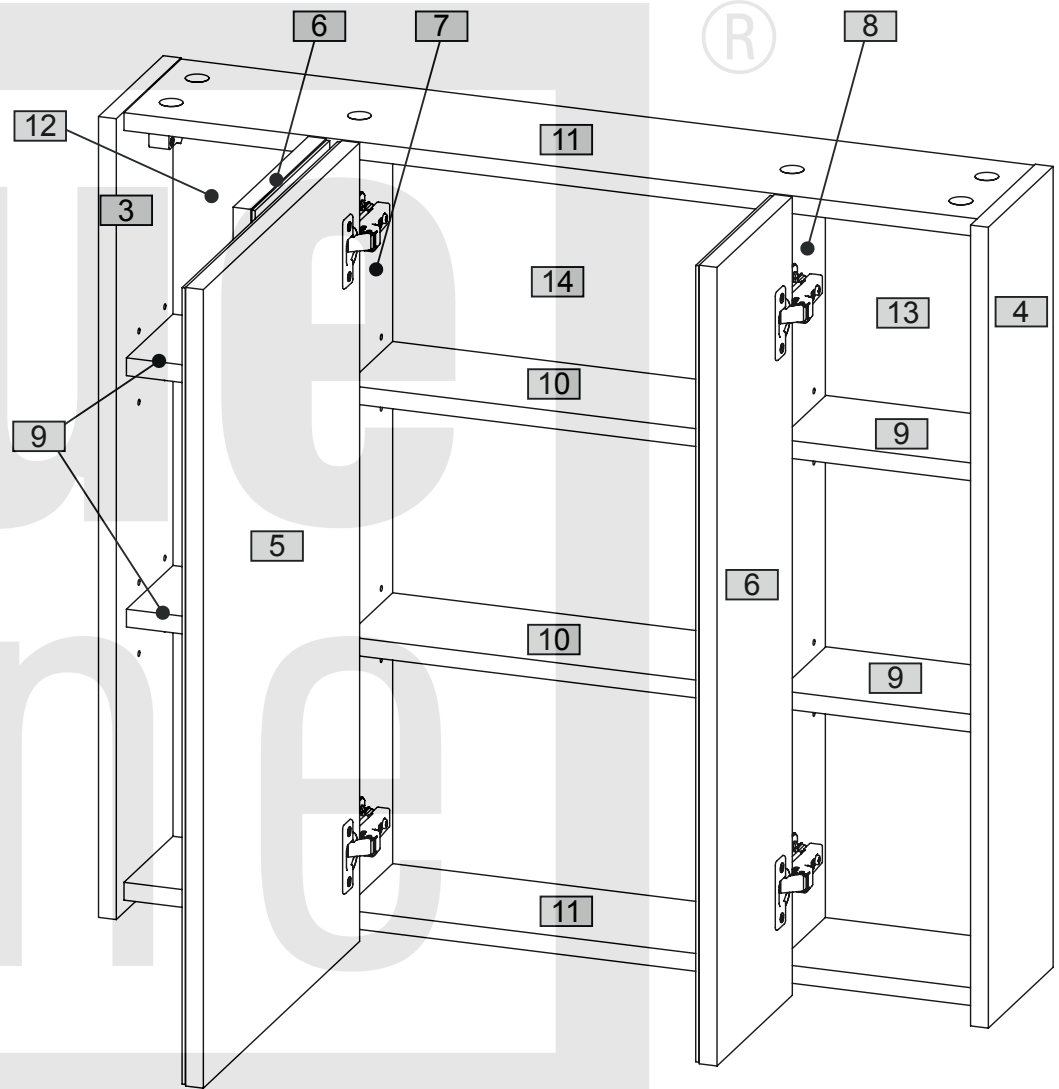
1

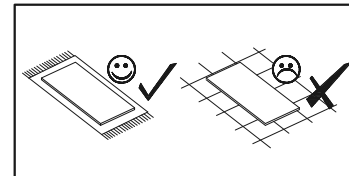
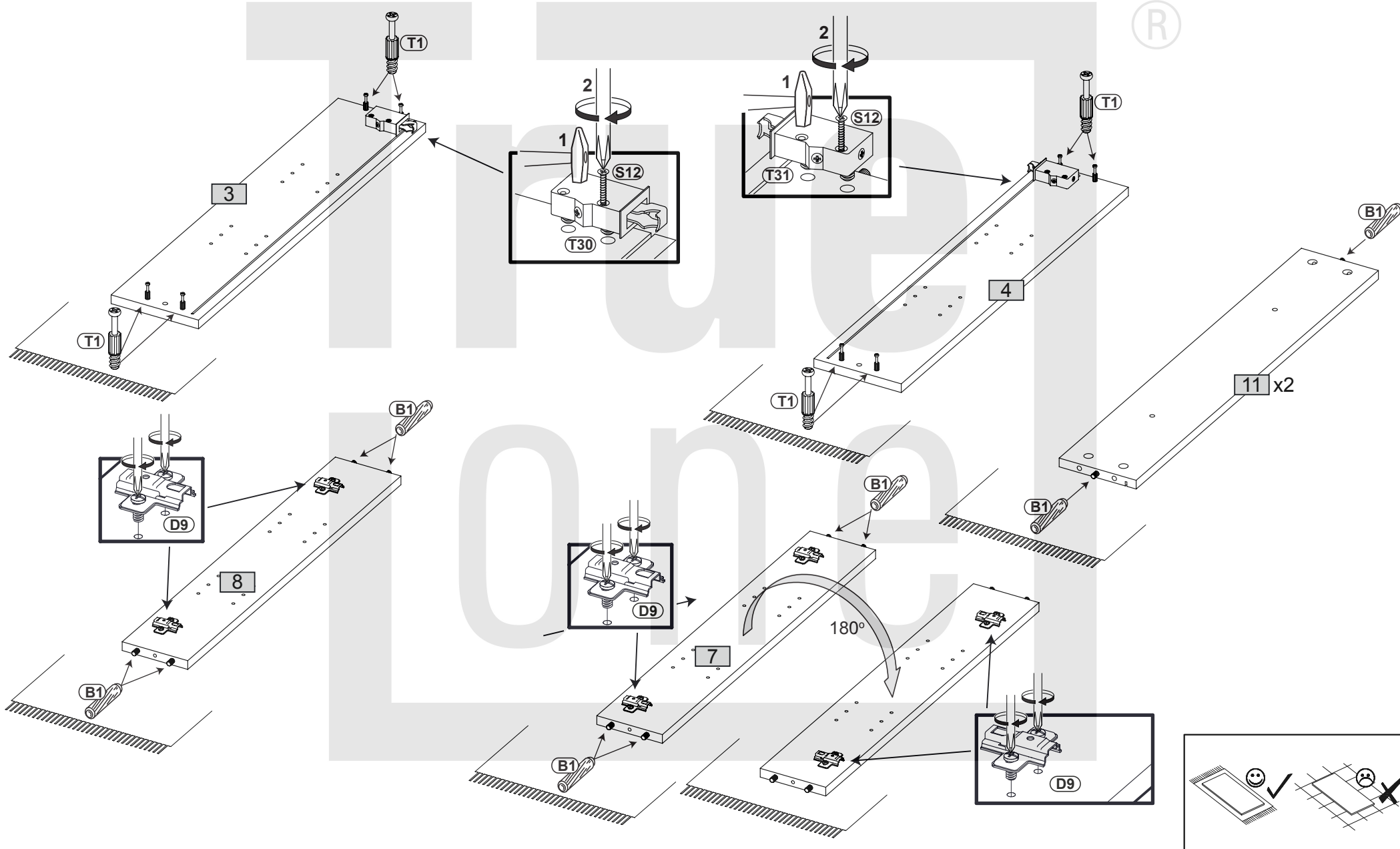
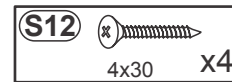
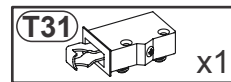
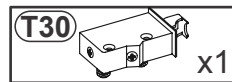
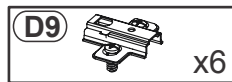
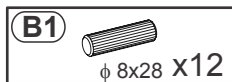
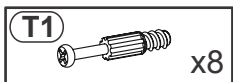

2

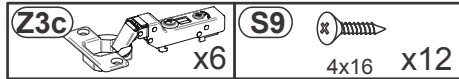

3

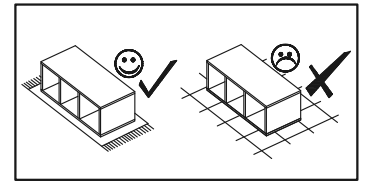
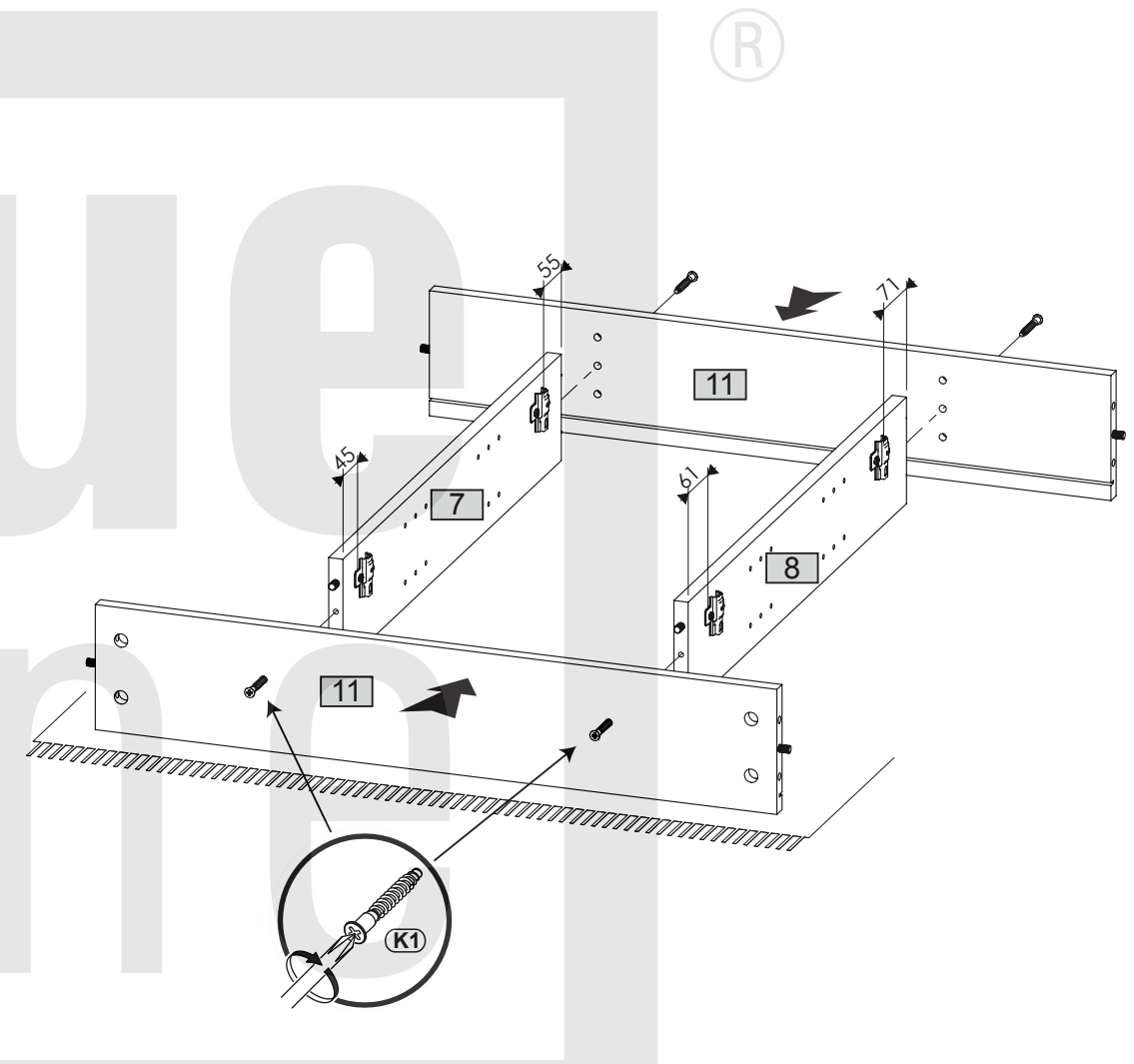
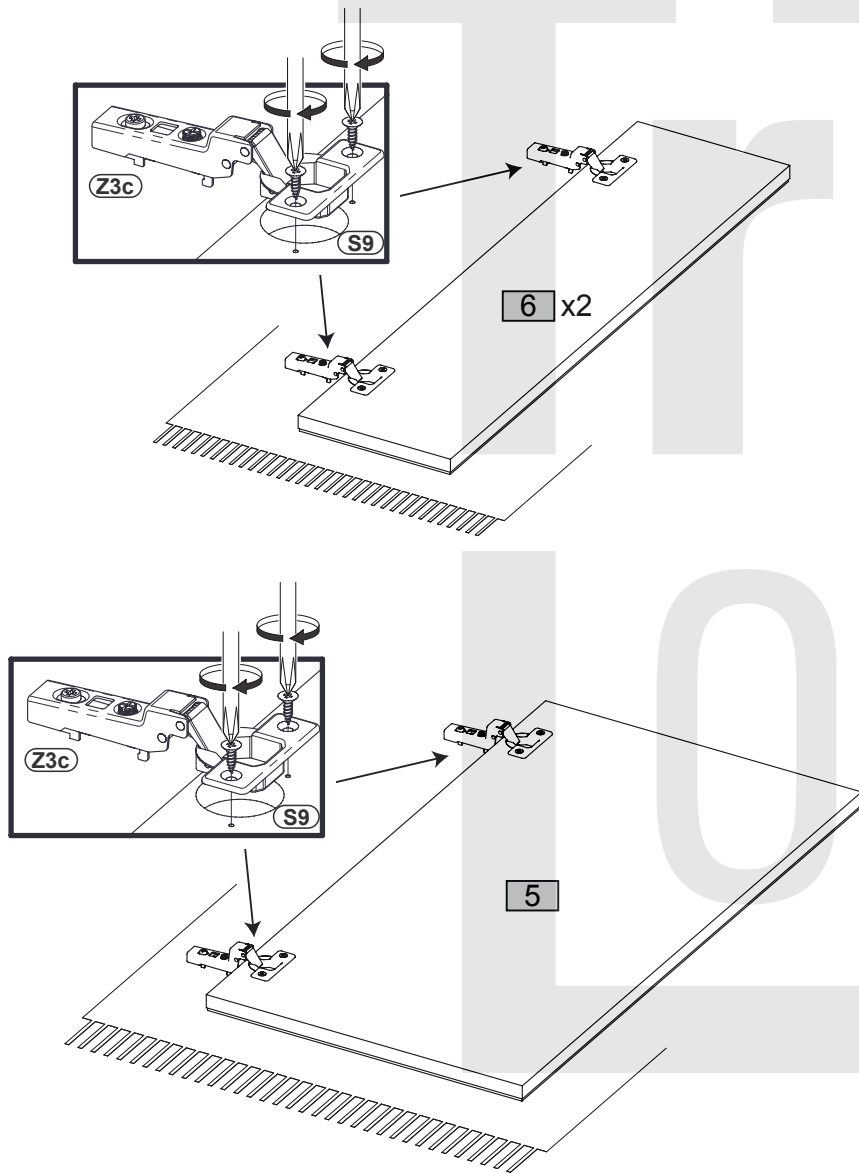
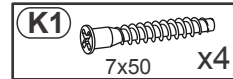

4 (M1) x4

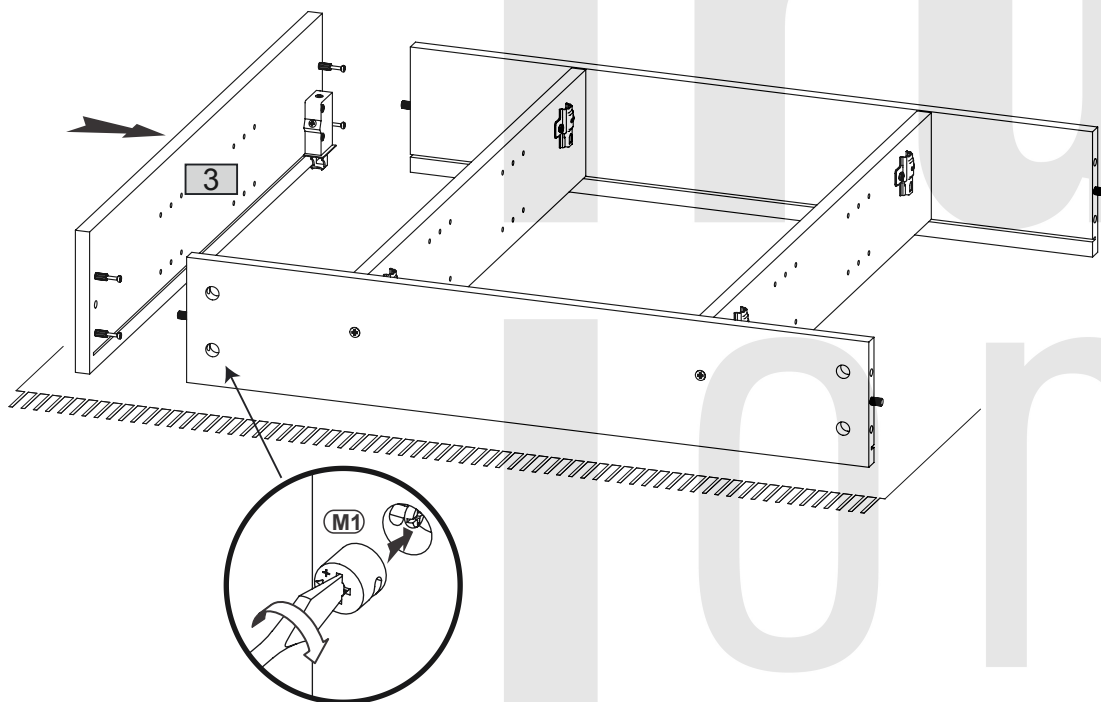

5 (M1) x4

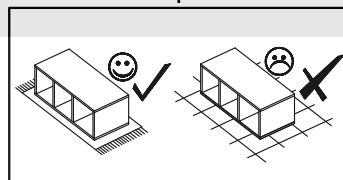
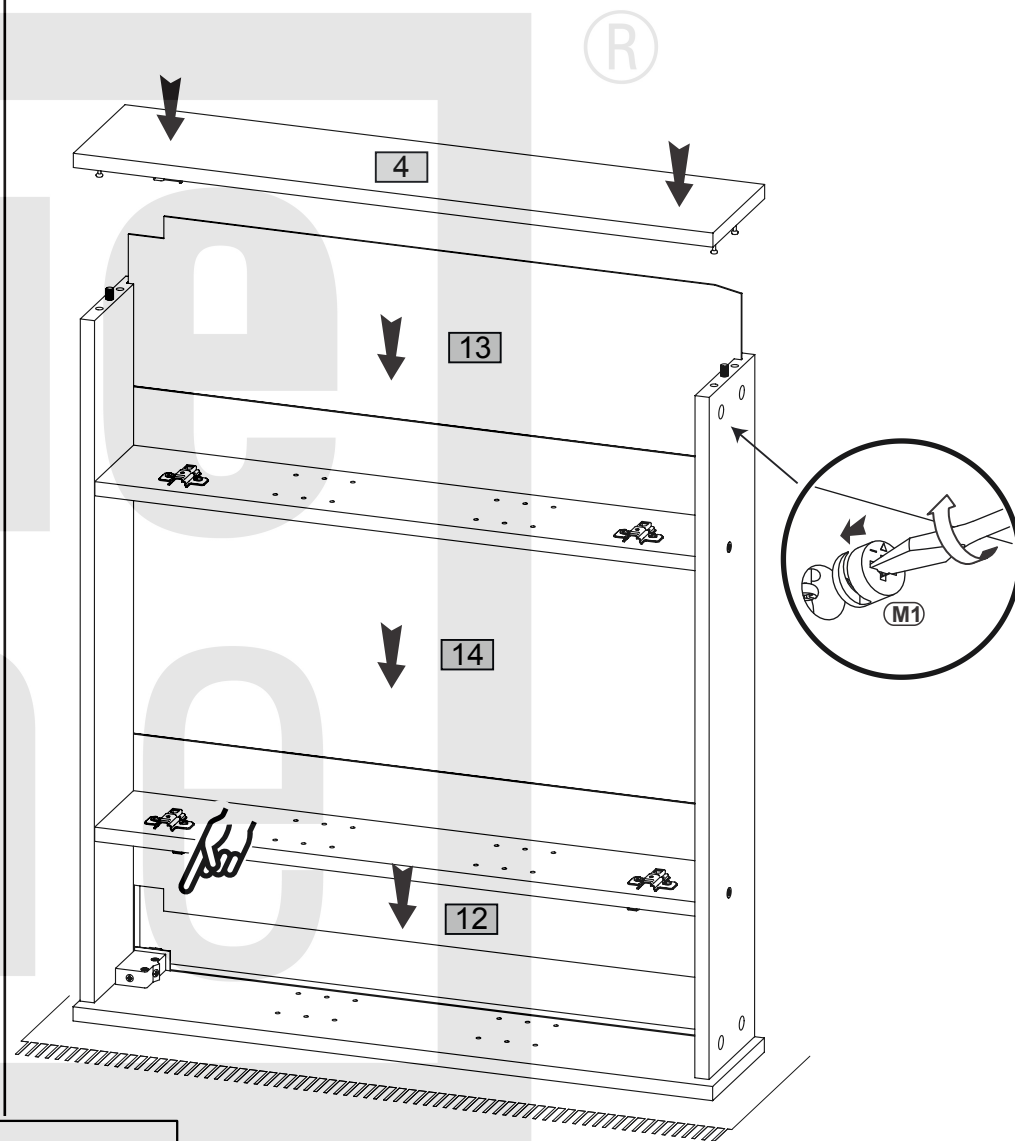

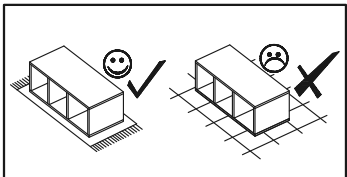
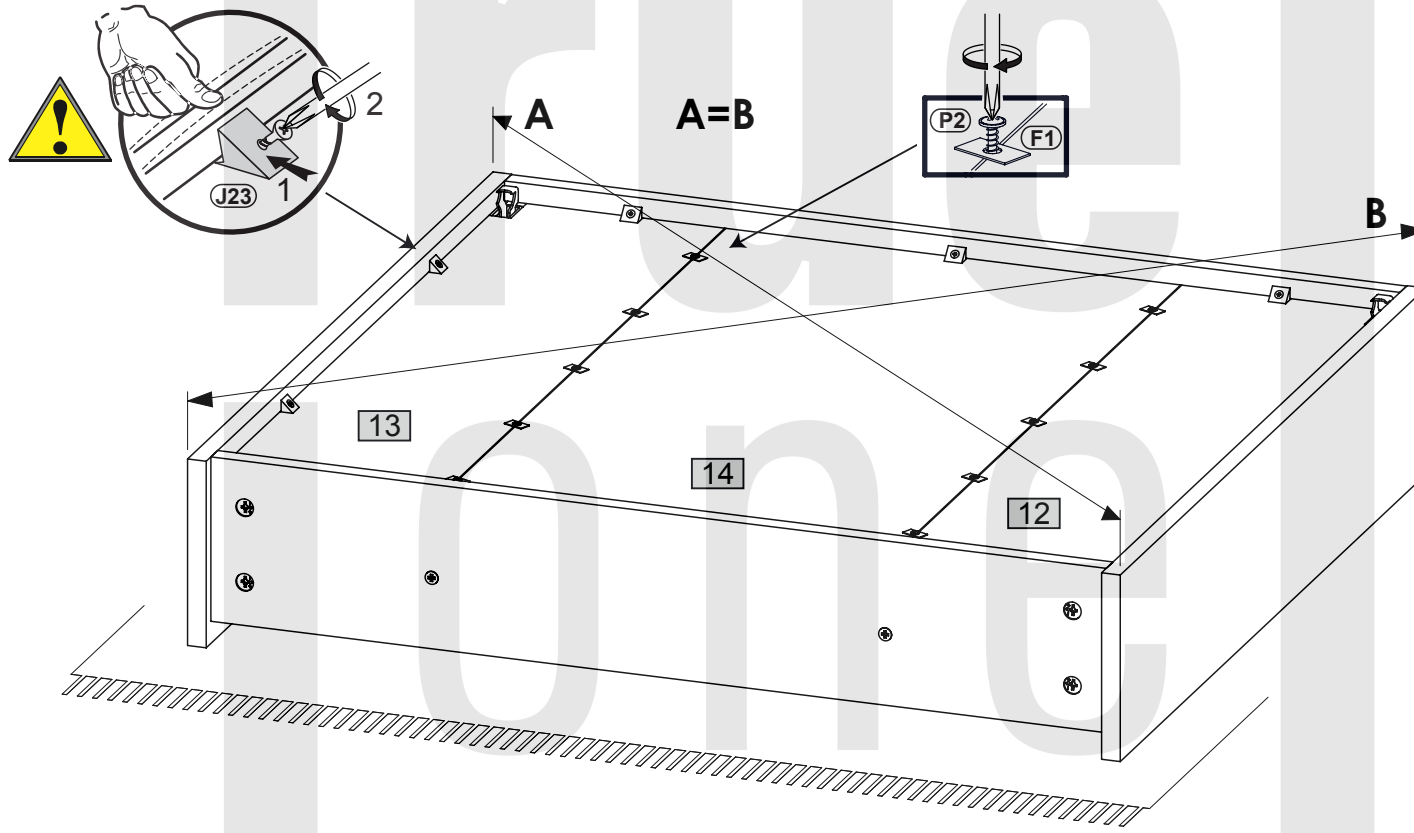
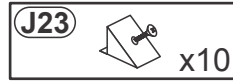
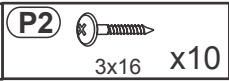

6

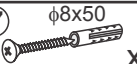

7

F33  x2

T17 $\phi 8 \times 50$
5x60  x4

W1  x24

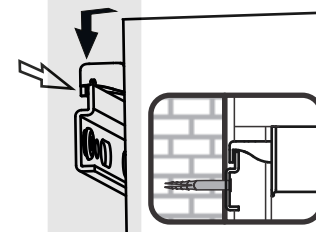
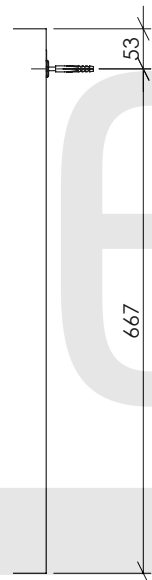
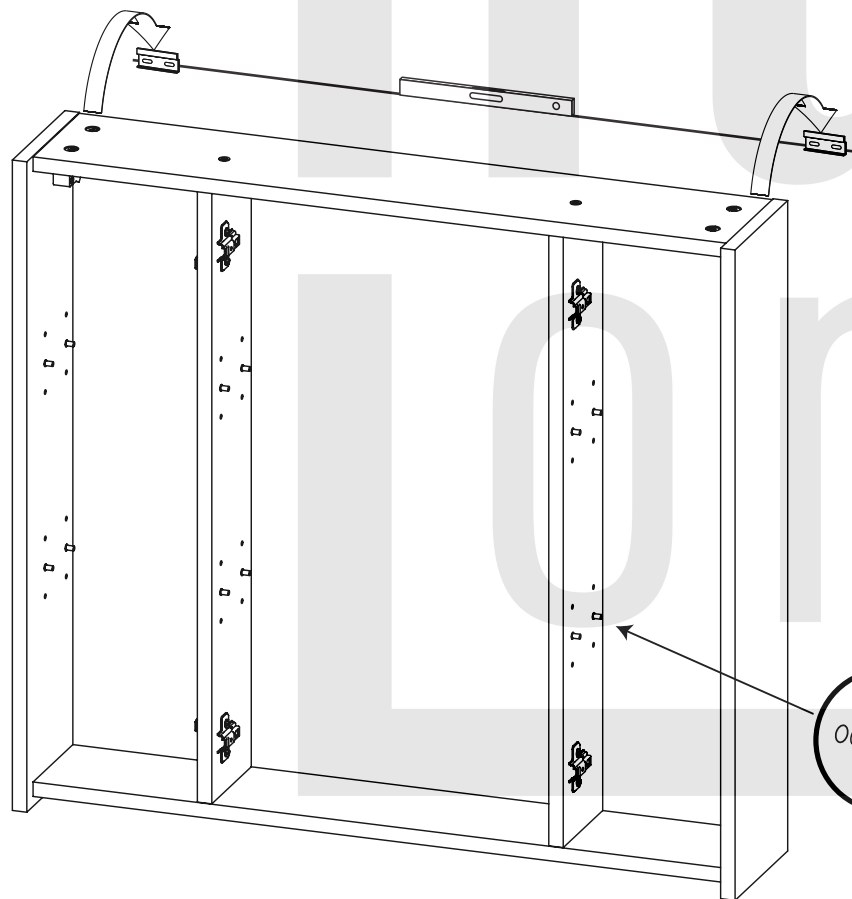
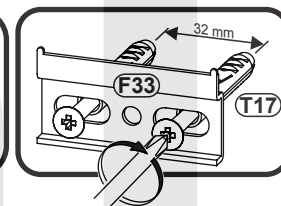
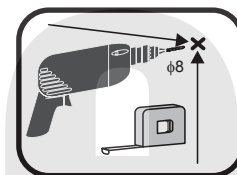
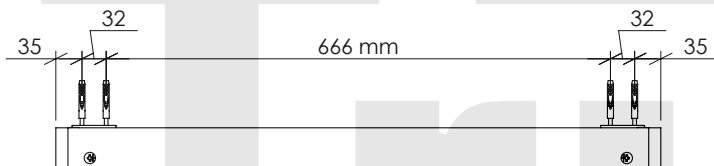
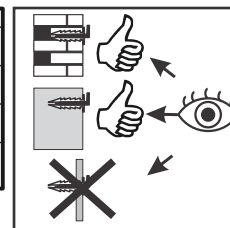
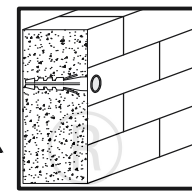

8

C2
φ 20 0 x12

