

L

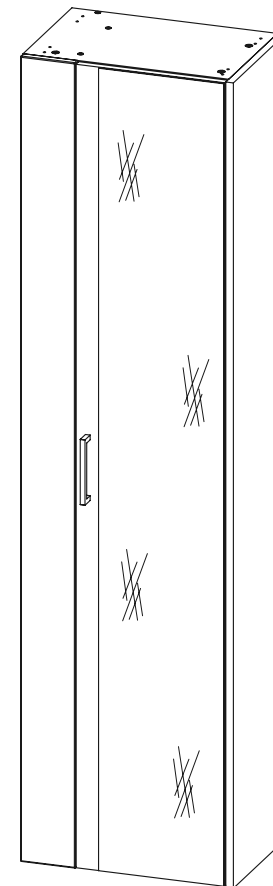

R

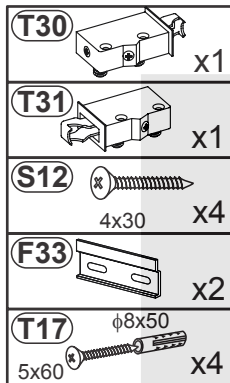
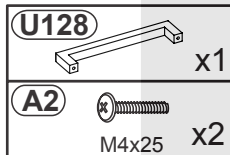
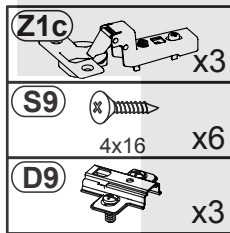
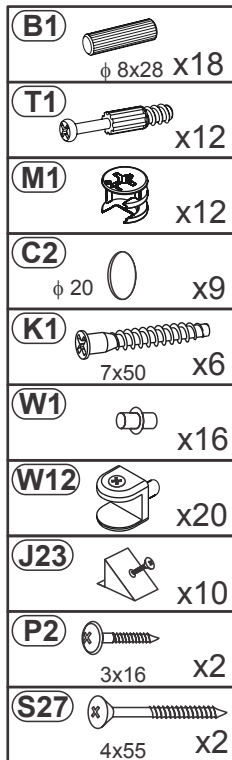

| Nr | Ausmaß |     |    | St |
|----|--------|-----|----|----|
| 2  | 258    | 98  | 4  | 5  |
| 3  | 1700   | 300 | 16 | 1  |
| 4  | 1668   | 283 | 16 | 1  |
| 5  | 1696   | 314 | 20 | 1  |
| 6  | 318    | 263 | 16 | 1  |
| 7  | 318    | 260 | 16 | 4  |
| 8  | 1668   | 99  | 16 | 1  |
| 9  | 434    | 283 | 16 | 1  |
| 10 | 434    | 283 | 16 | 1  |
| 11 | 1700   | 116 | 16 | 1  |
| 12 | 1682   | 332 | 2  | 1  |

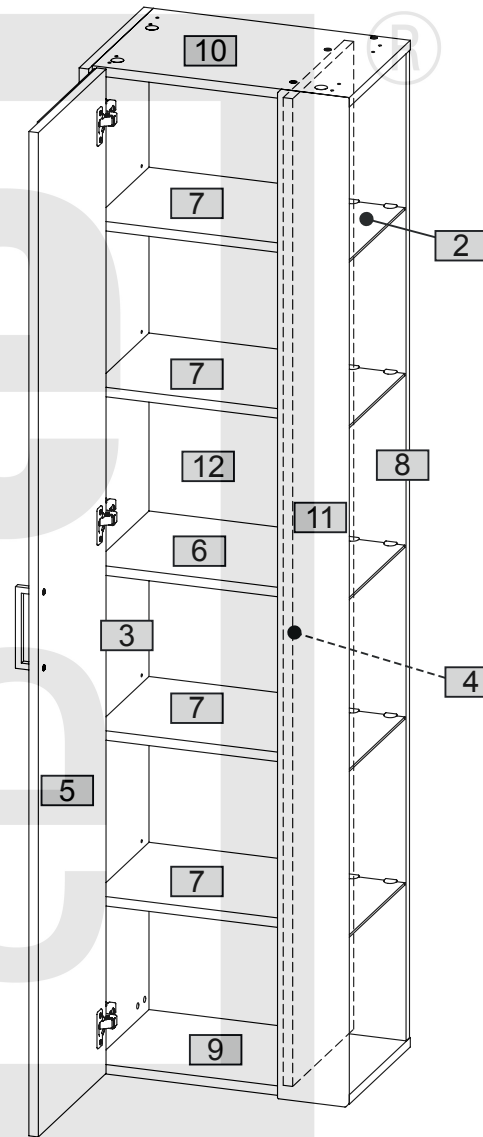

## 1L

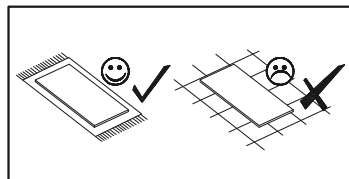
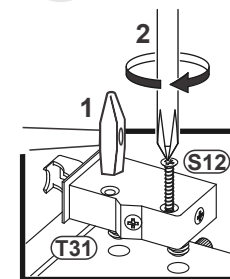
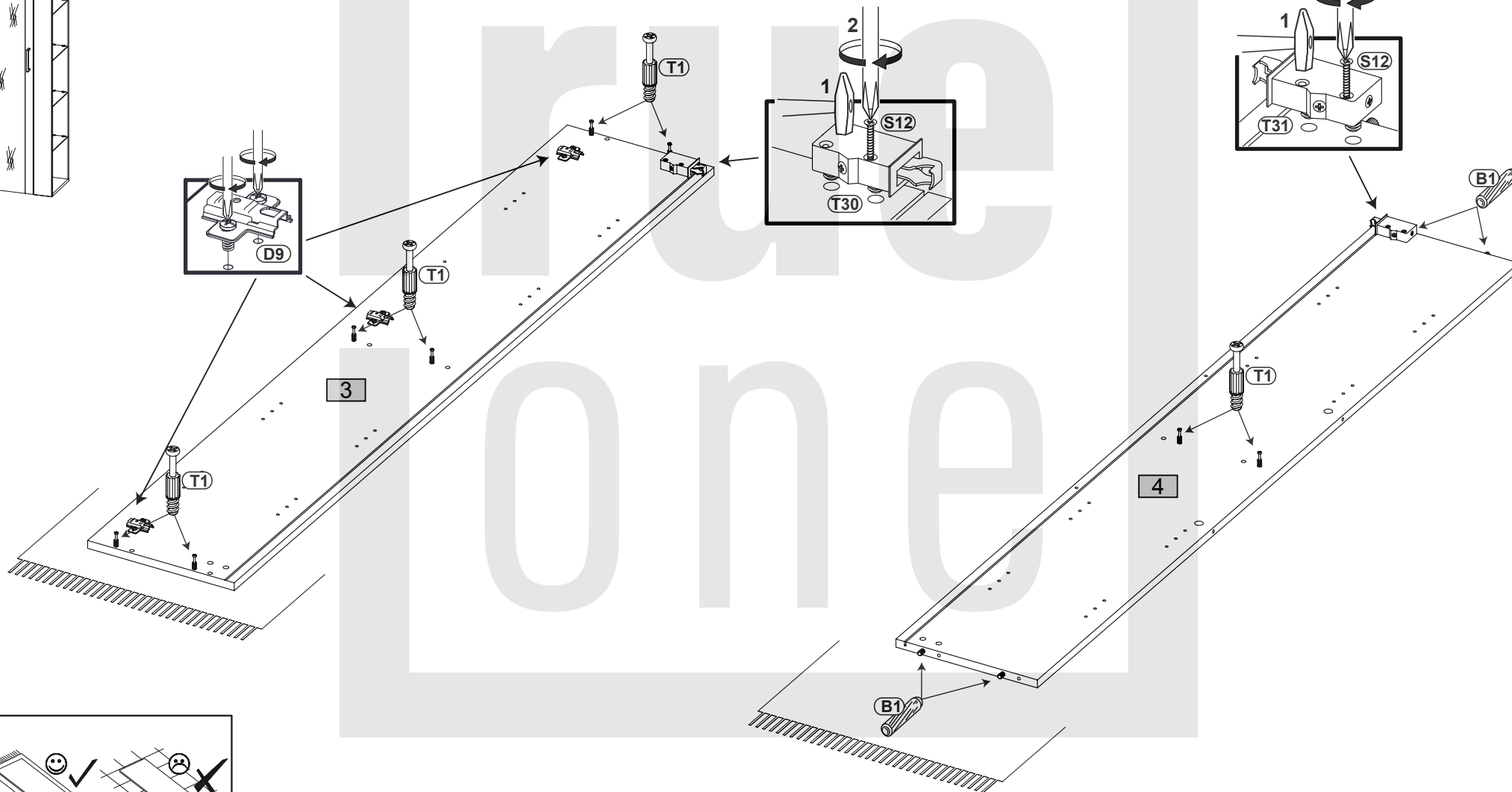
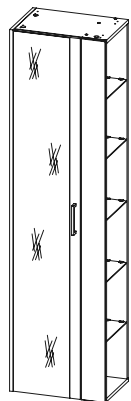
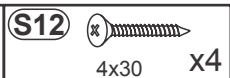
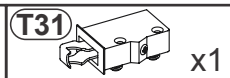
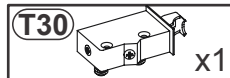
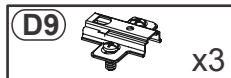
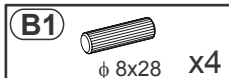
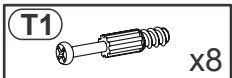

## 2

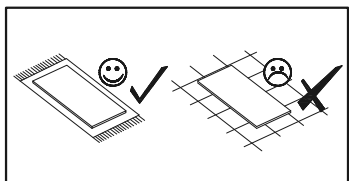
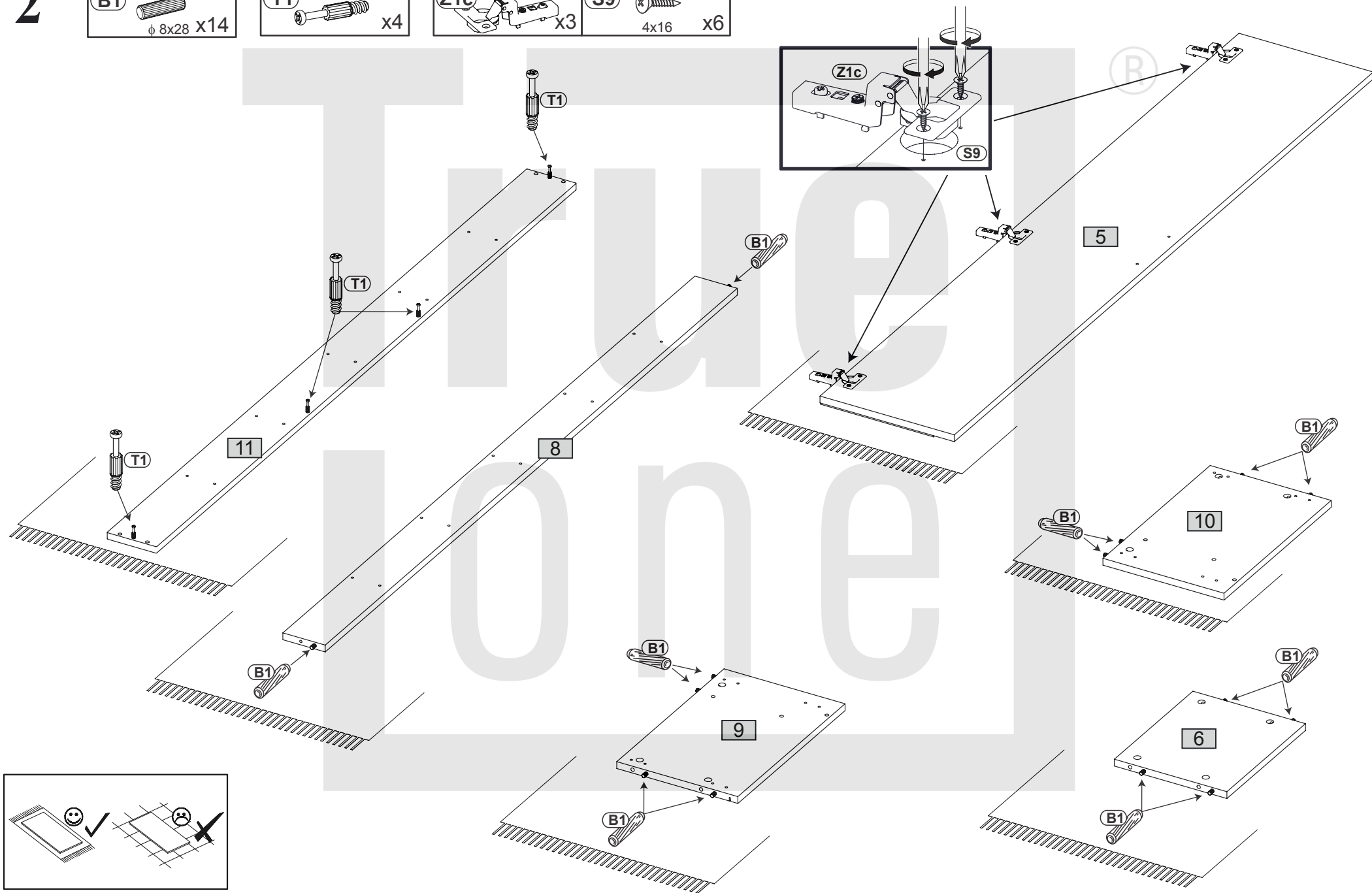
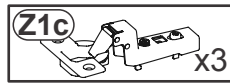
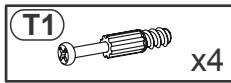
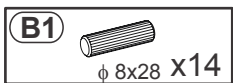

3L

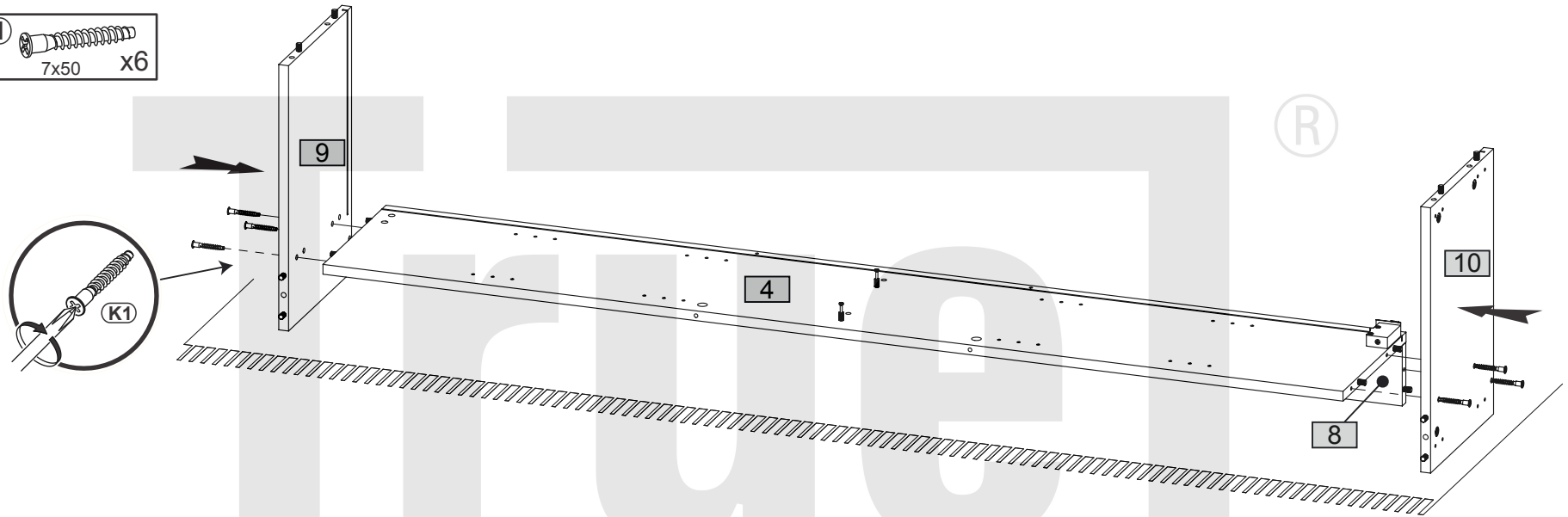
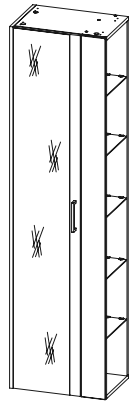
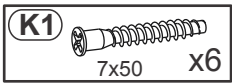

4L

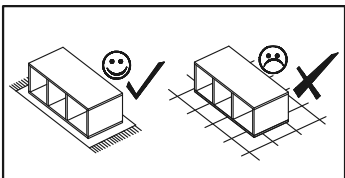
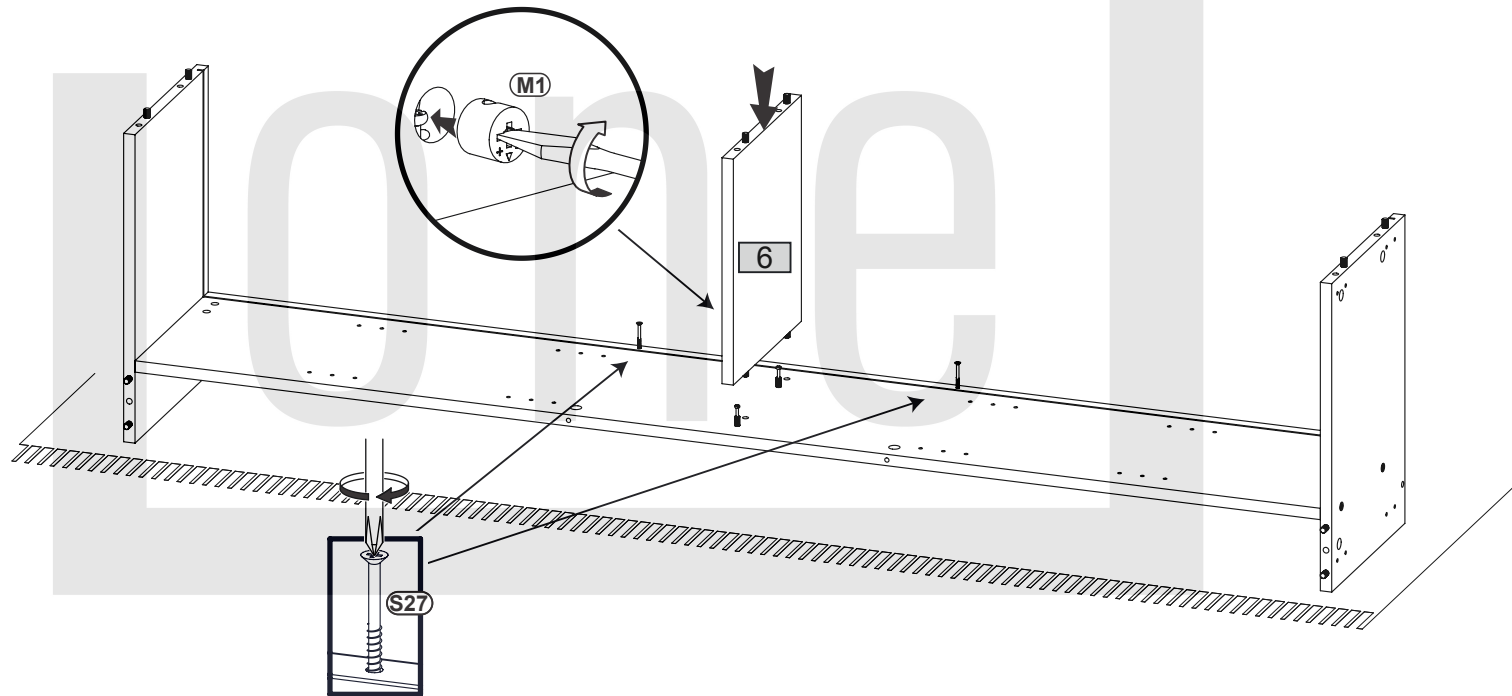
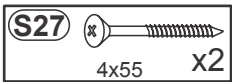

5L

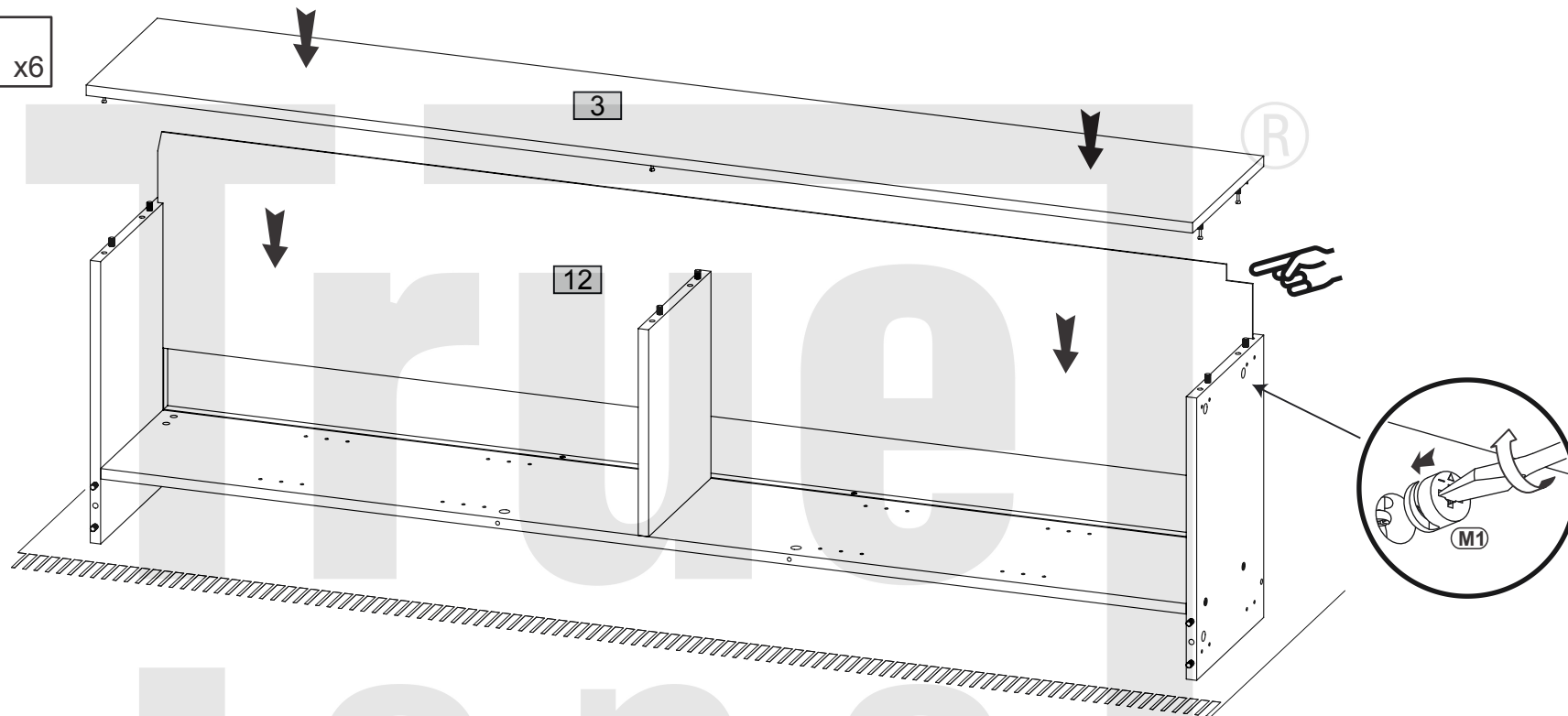

6L

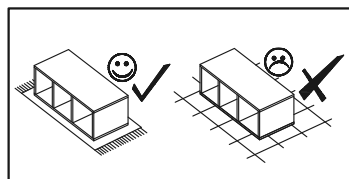
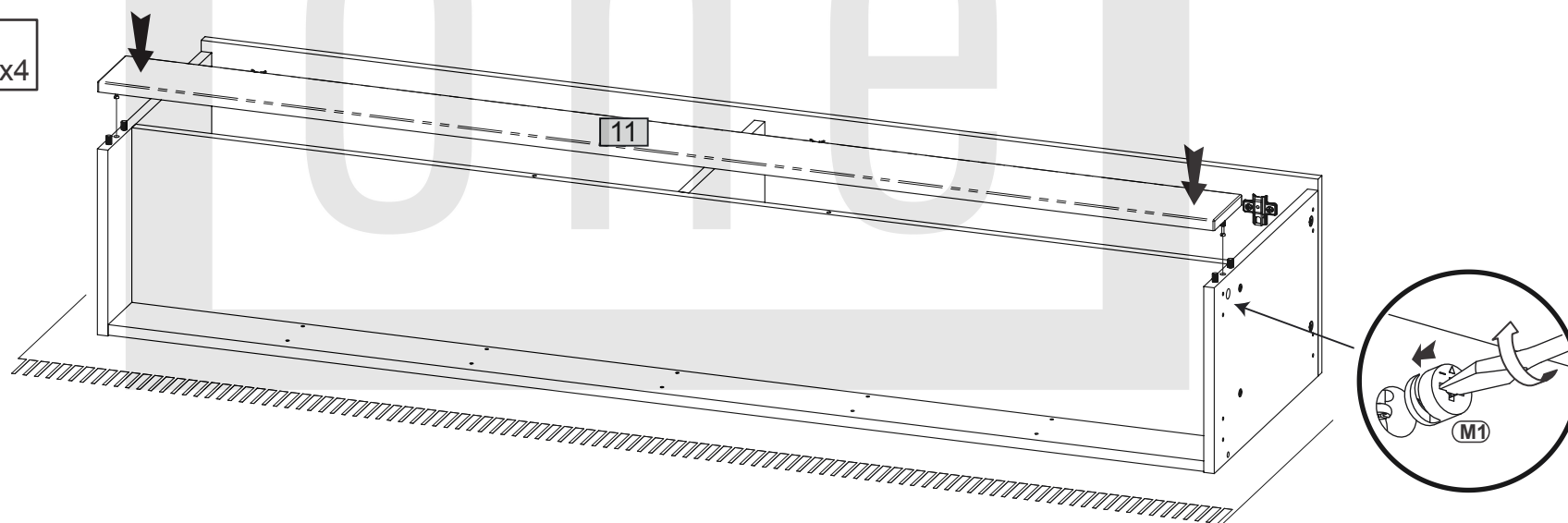

## 7L

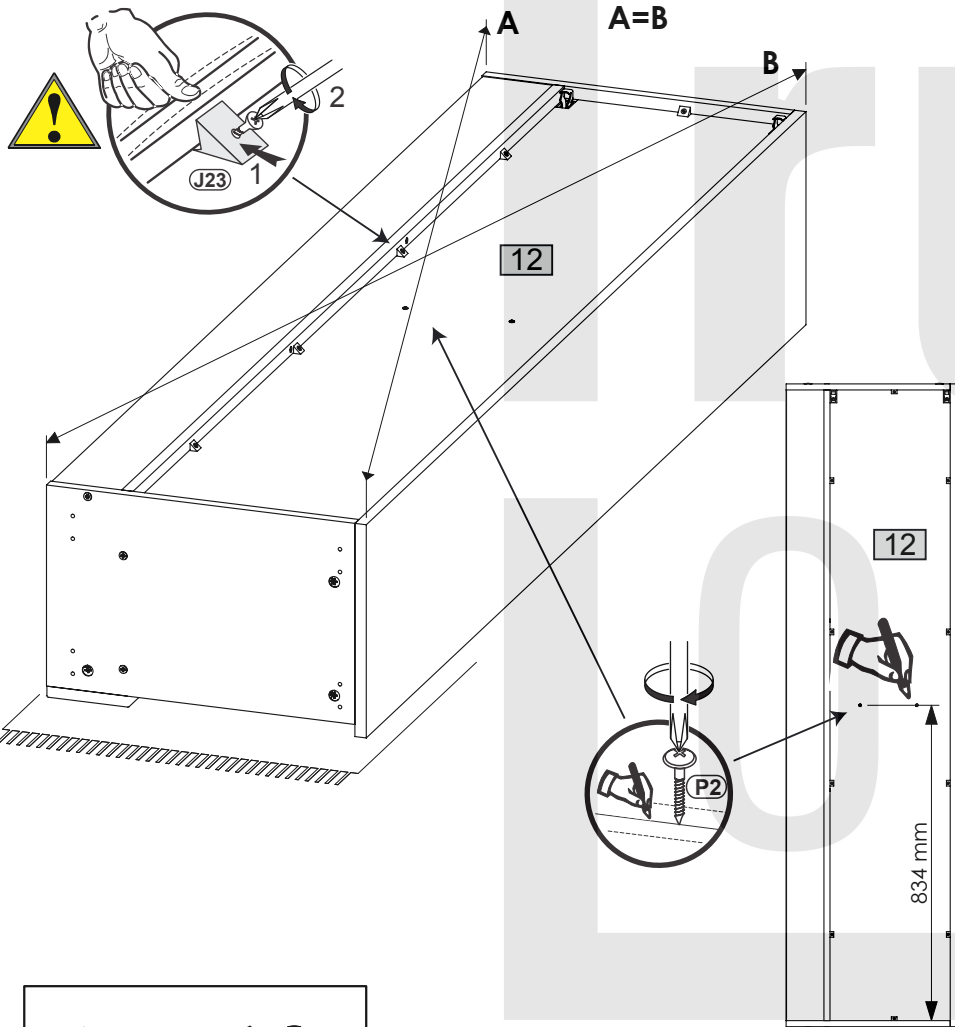
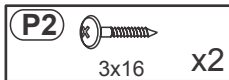
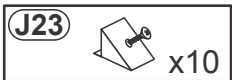

## 8L

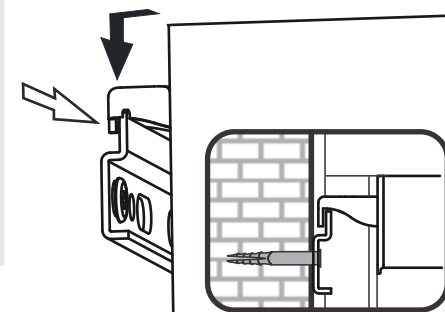
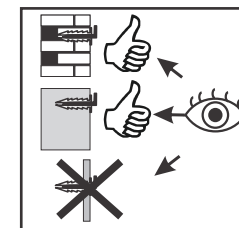
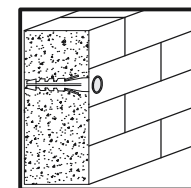
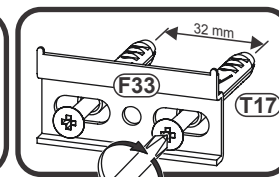
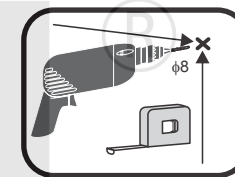
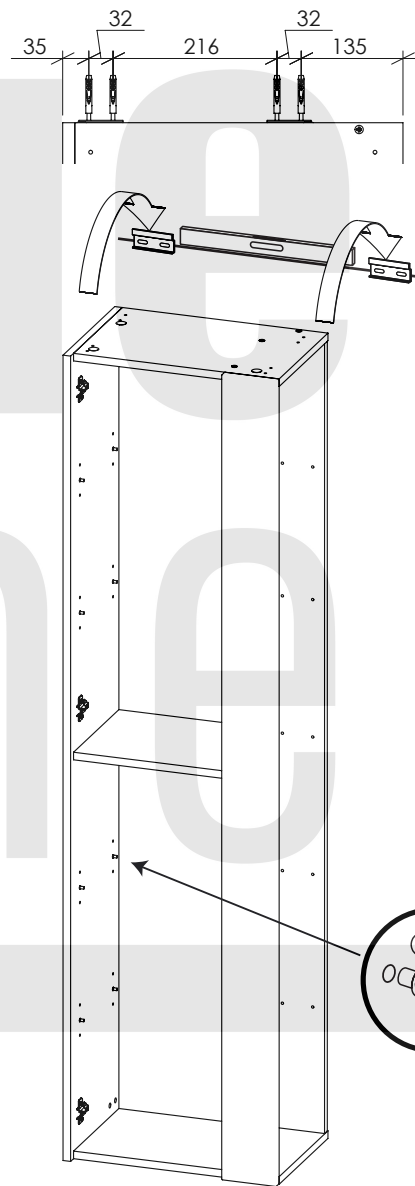
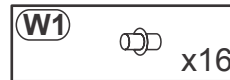
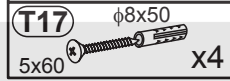
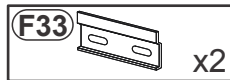

# 9L

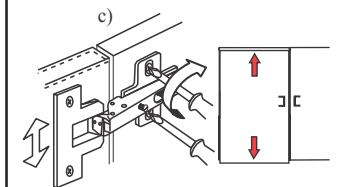
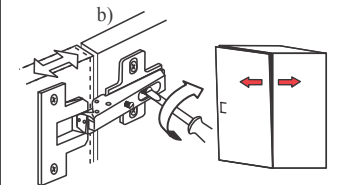
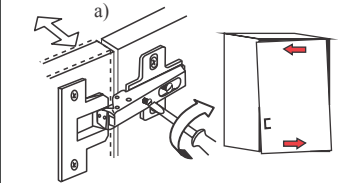
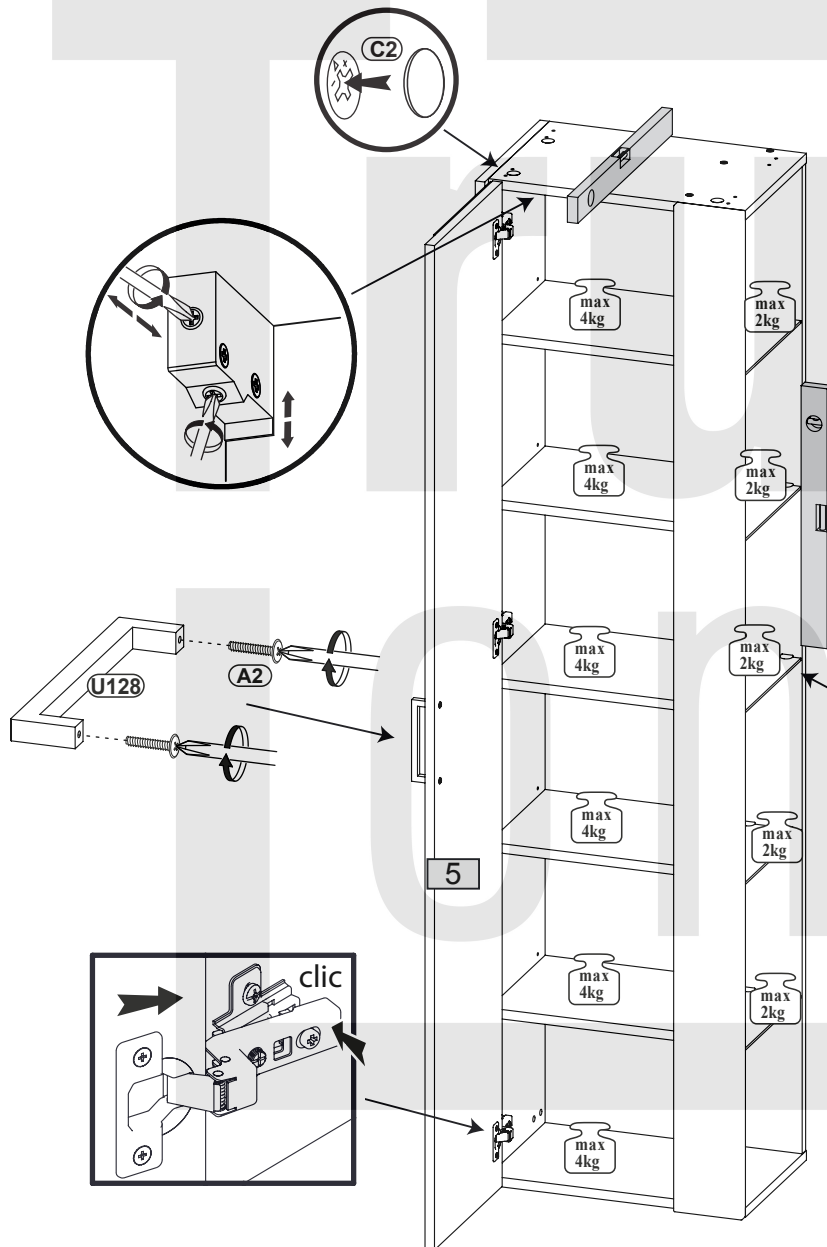
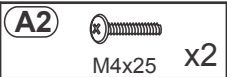
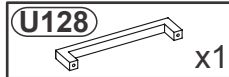





Typ 880

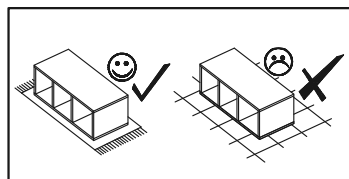
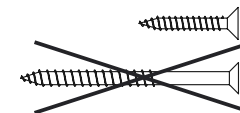
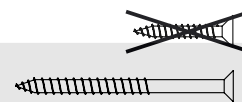
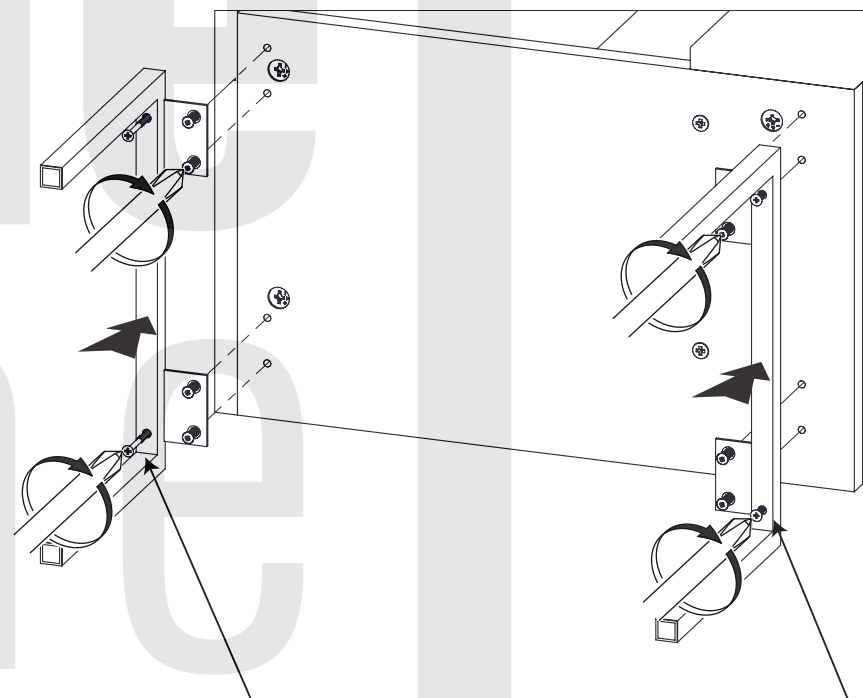
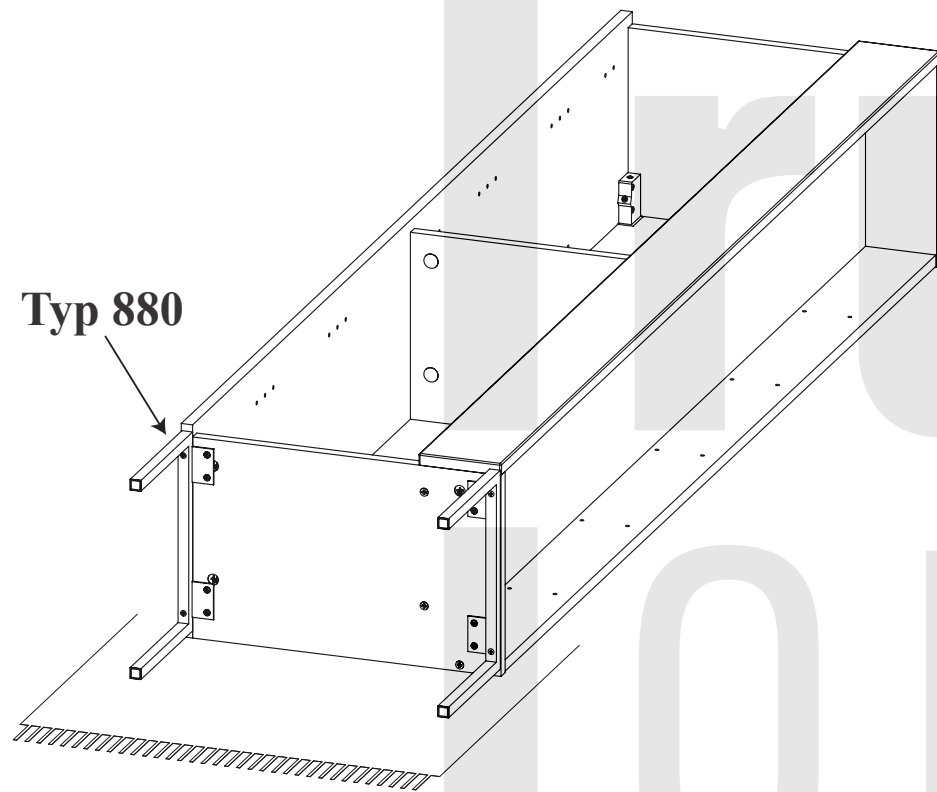

## 1R

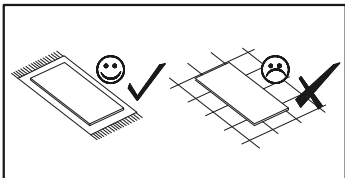
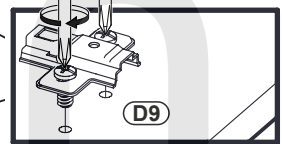
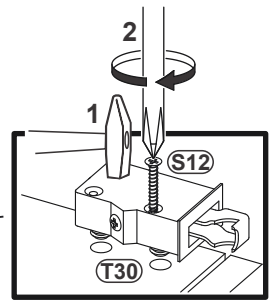
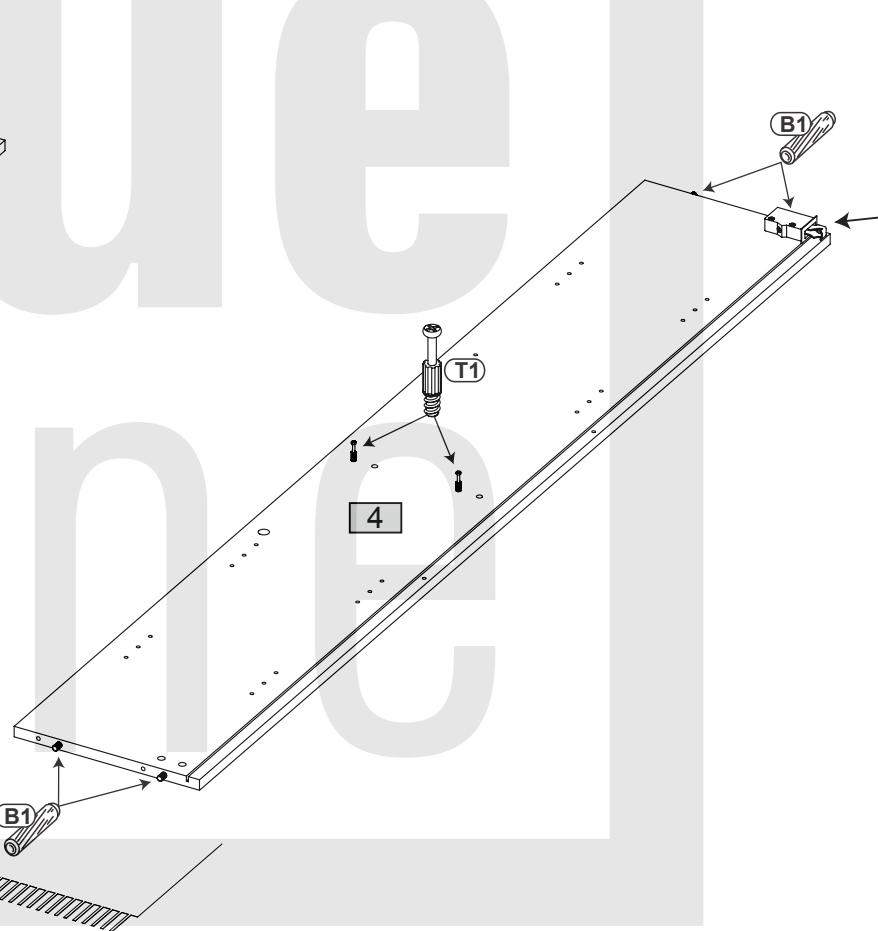
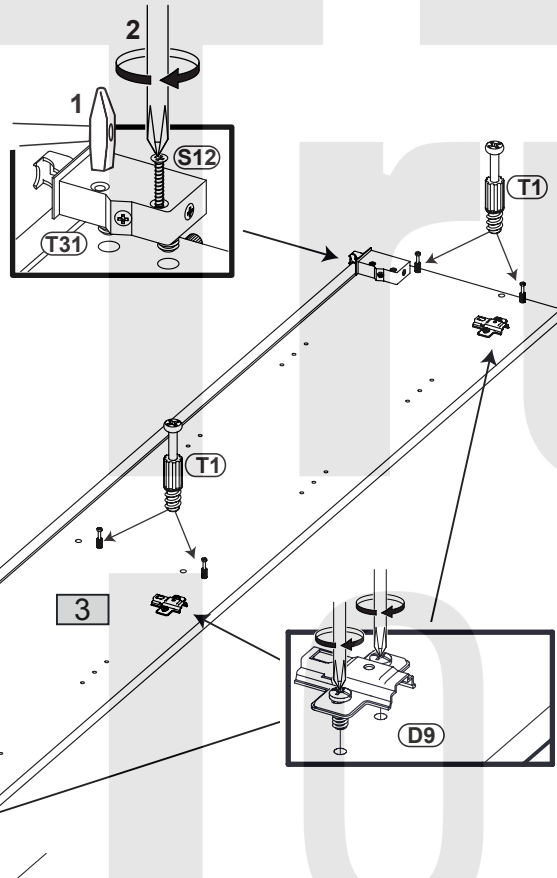
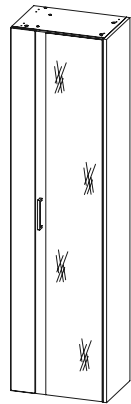
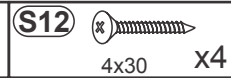
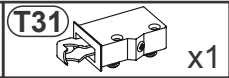
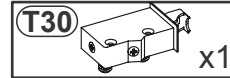
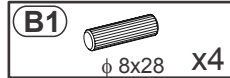
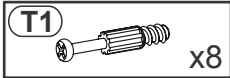

## 2

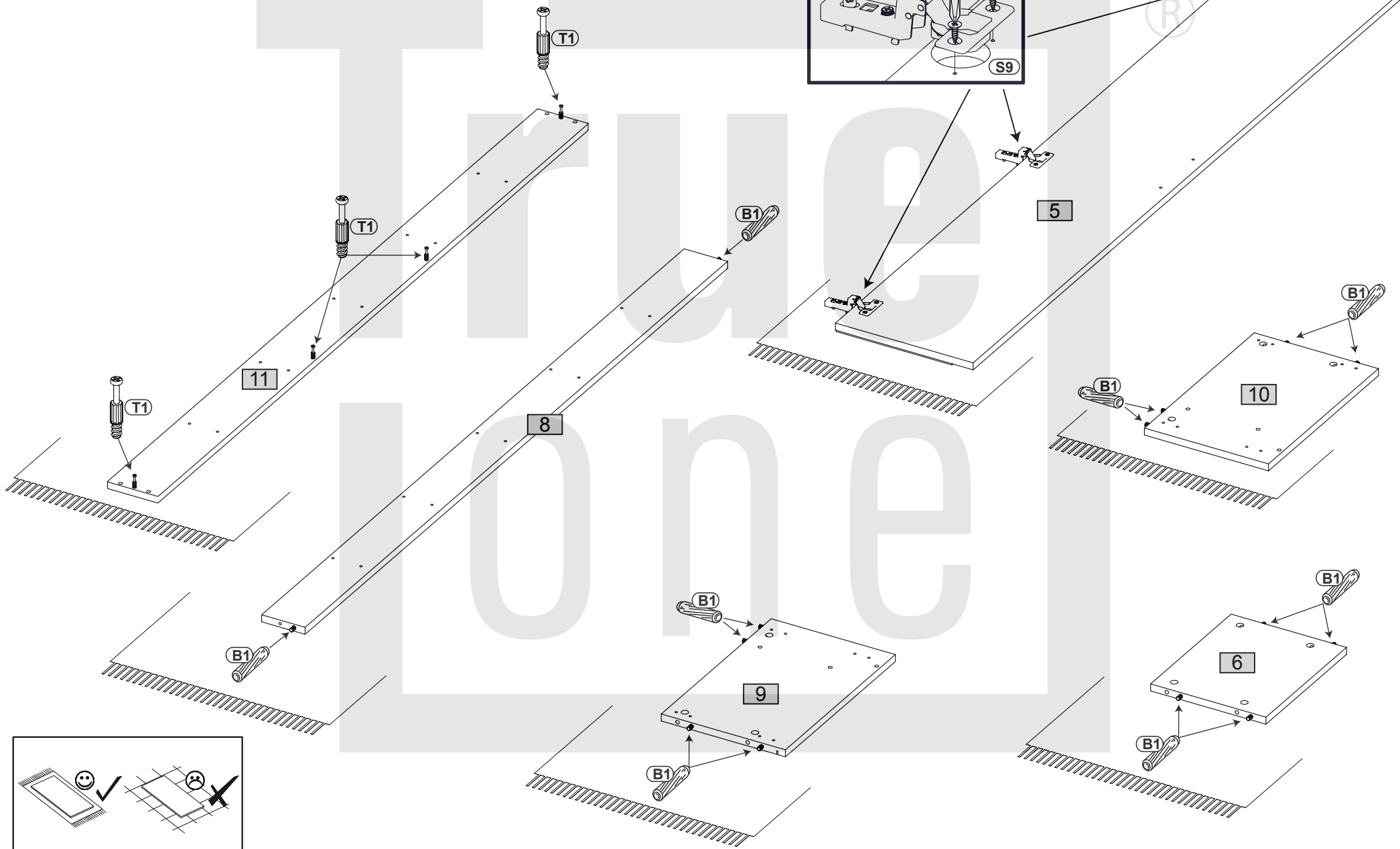
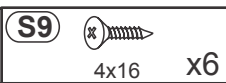
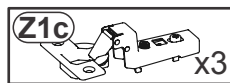
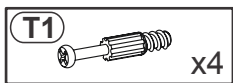
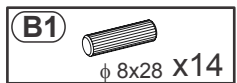

3R

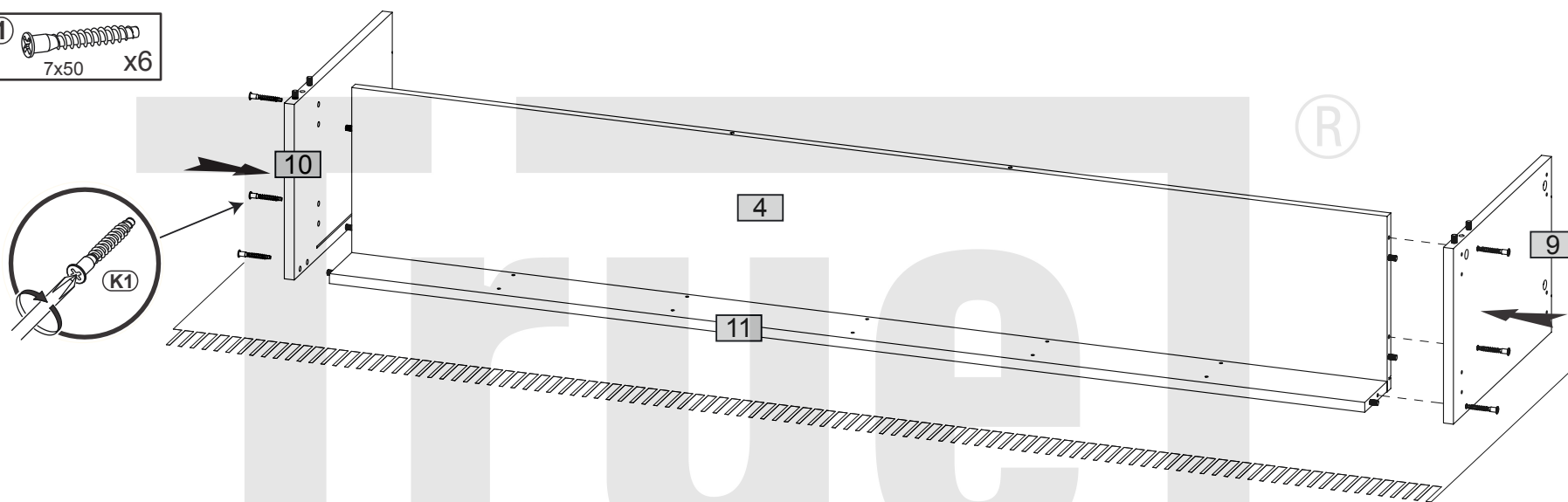
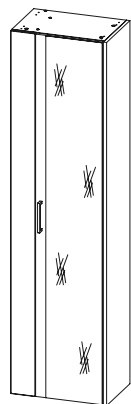
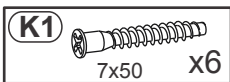

4R

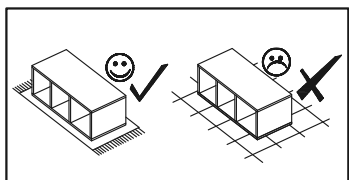
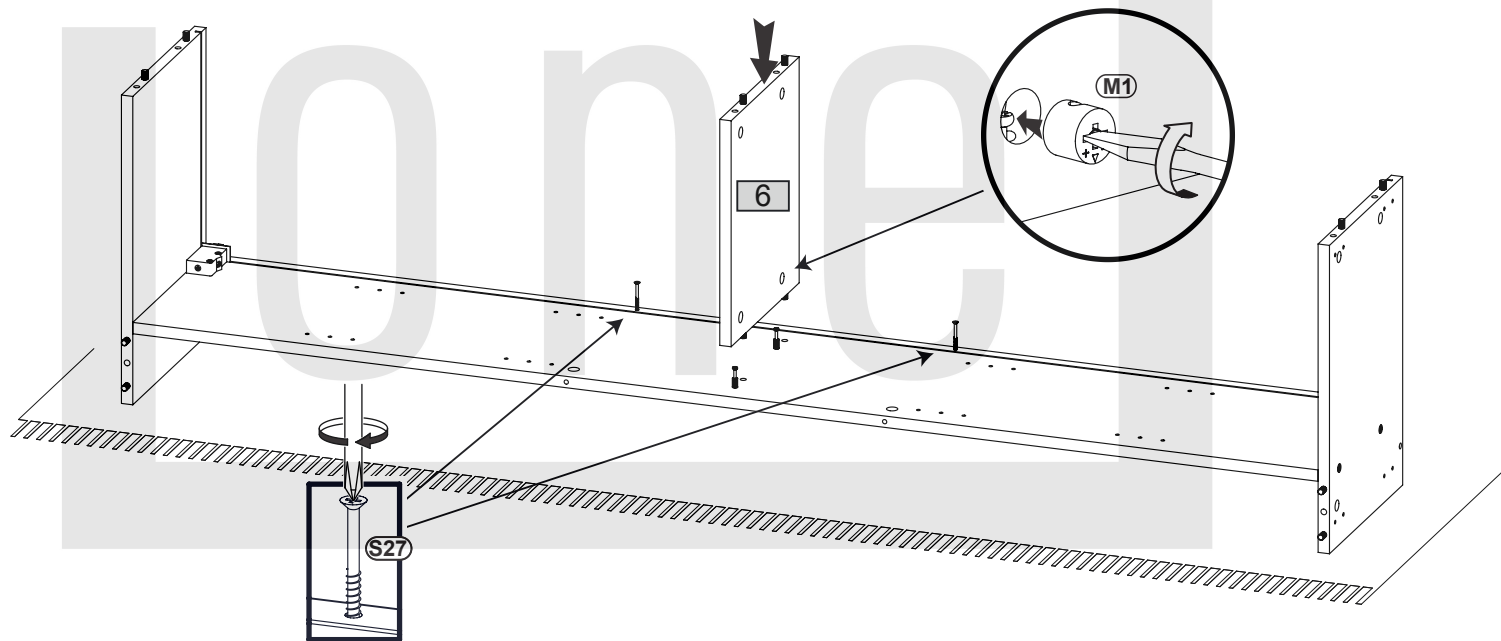
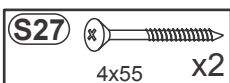

5R

M1  x6

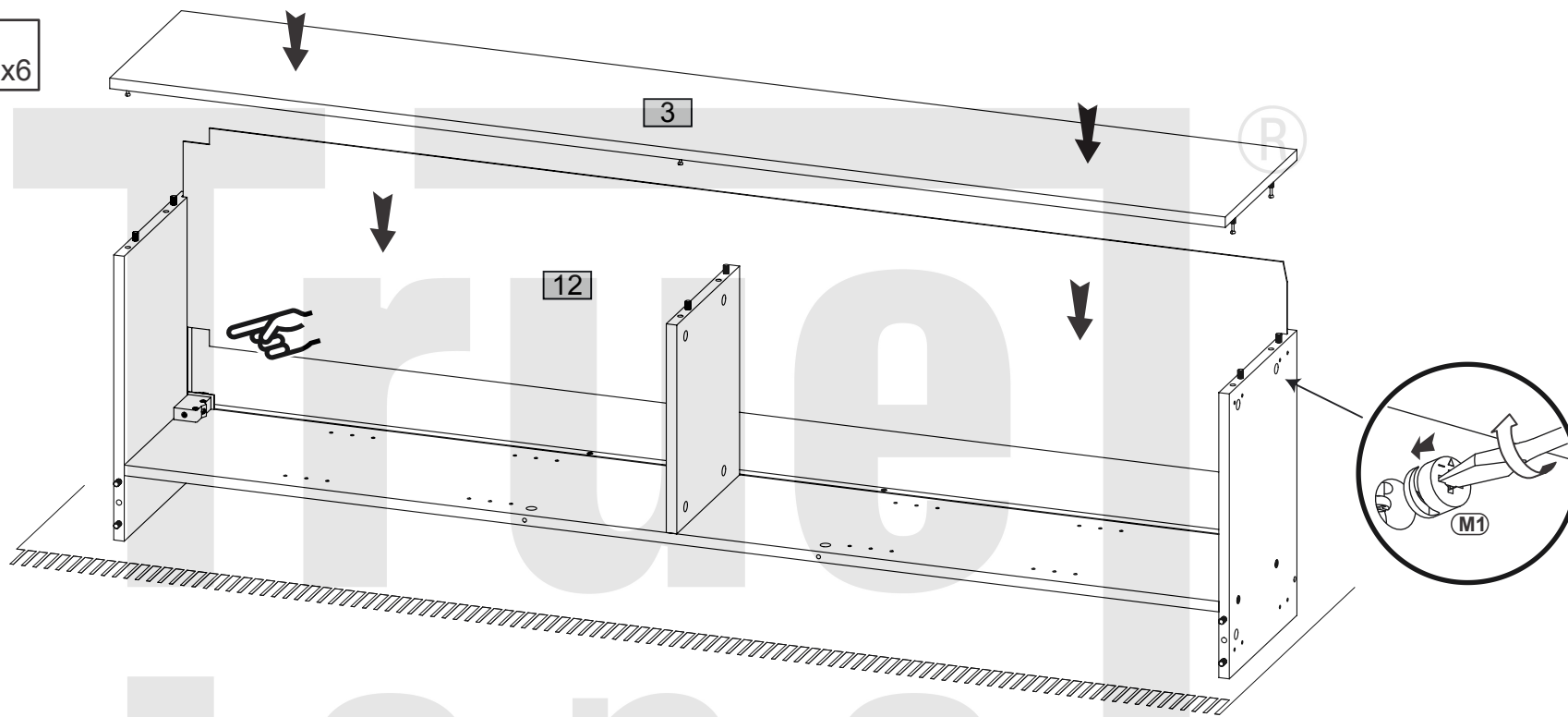

6R

M1  x4

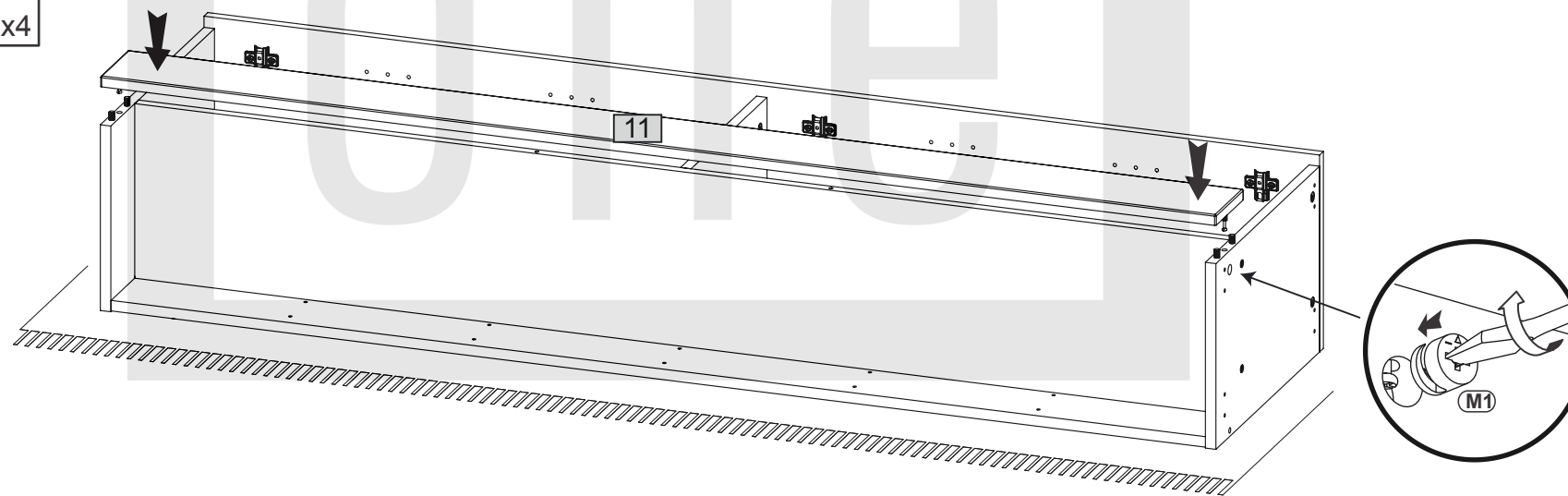

7R

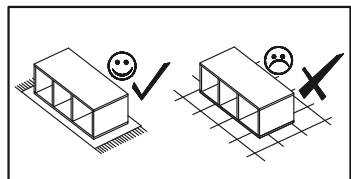
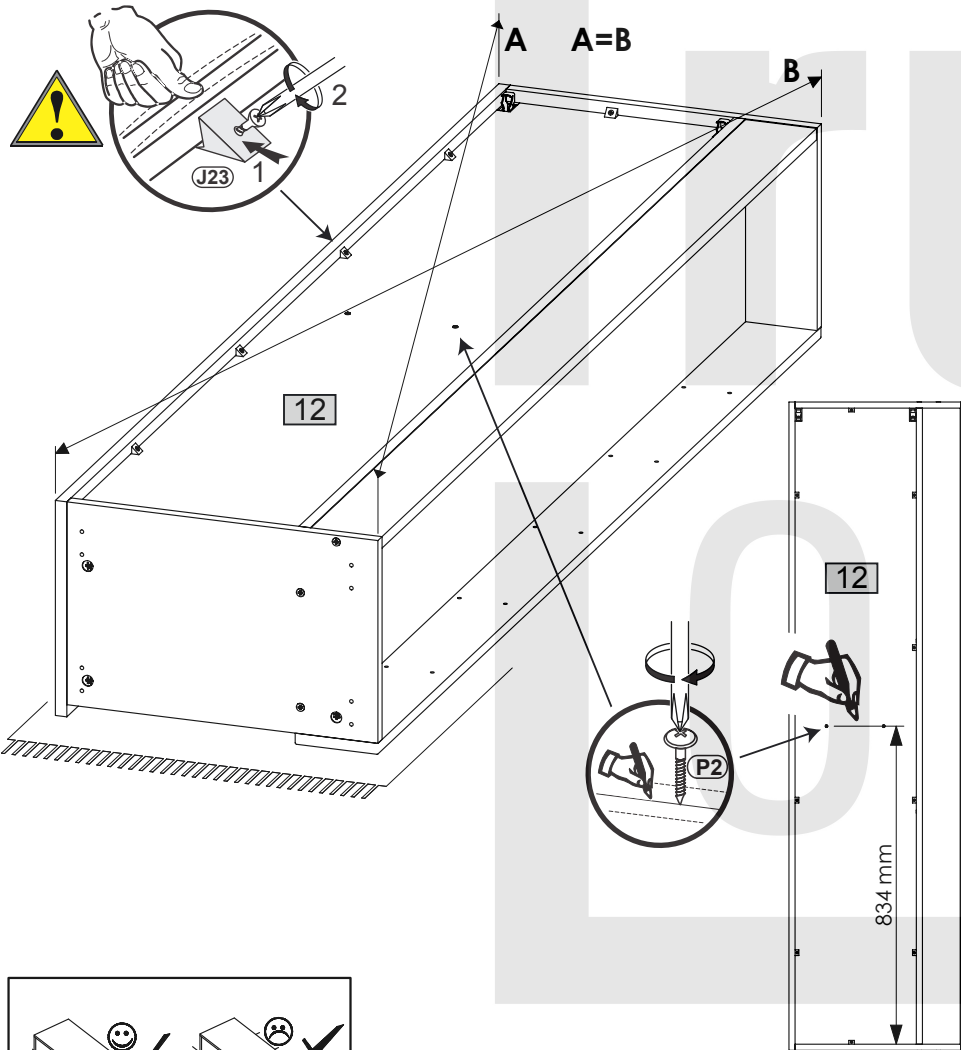
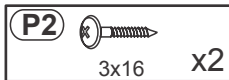
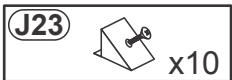

8R

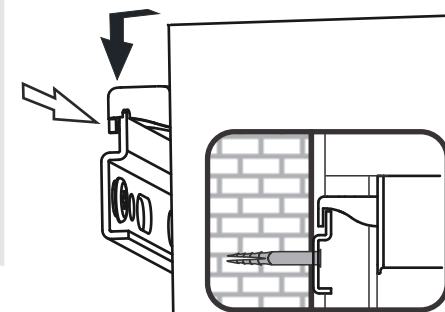
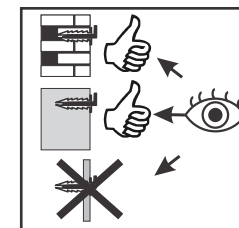
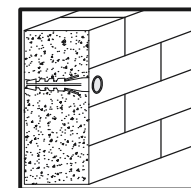
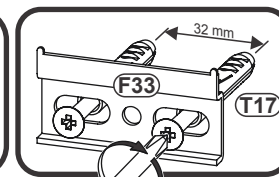
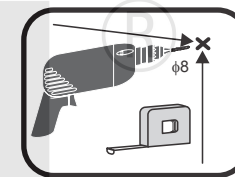
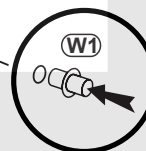
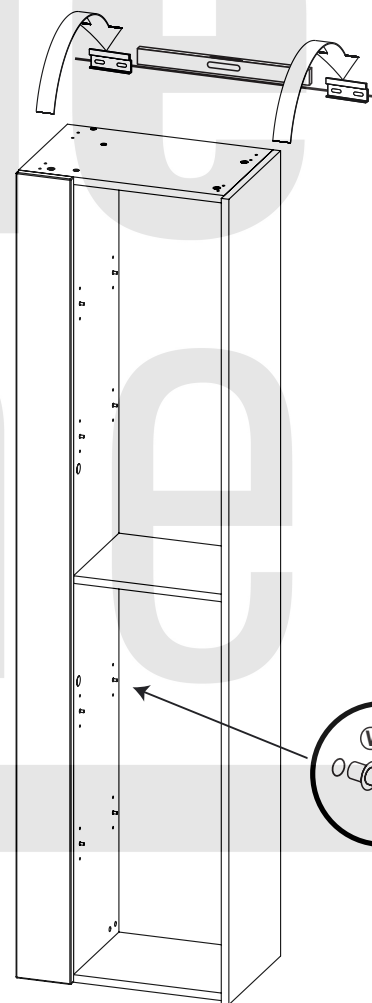
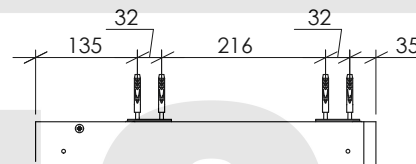
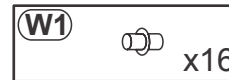
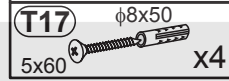
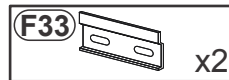

## 9R

**U128**



x1

**A2**



M4x25

x2

**C2**

φ 20



x9

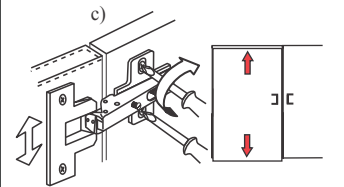
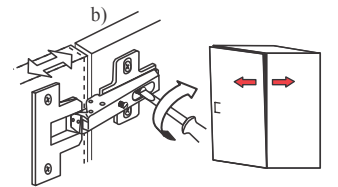
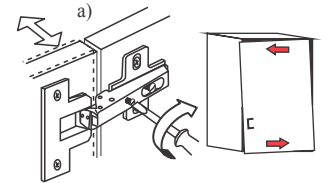
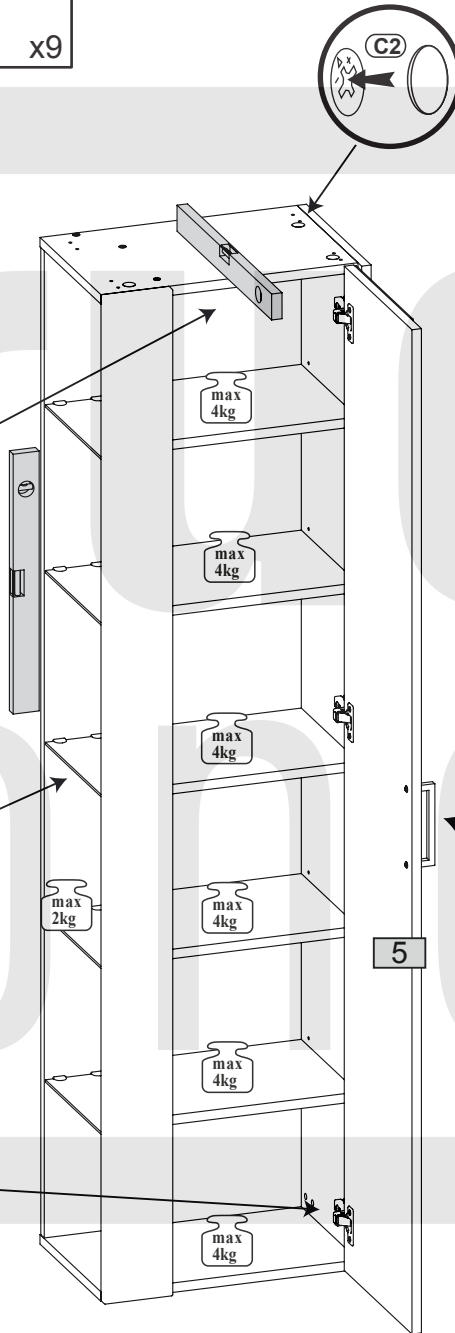
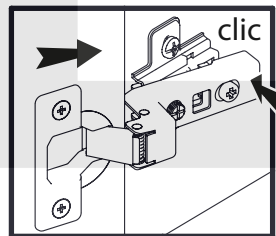
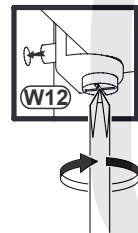
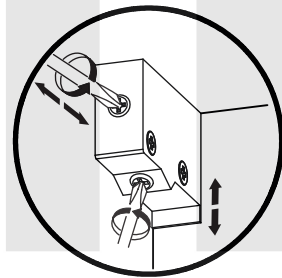



Typ 880

