

# SŁUPEK WYSOKI 1D

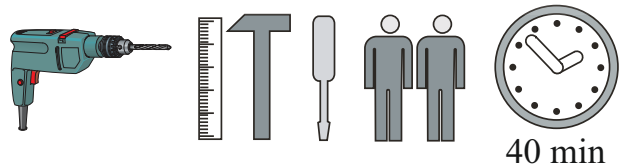

NO	Dim.			Col.-No	Qty
1	1400	236	16	1	2
2	318	235	16	1	2
3	318	212	16	1	1
4	318	204	16	1	2
5	1394	346	16	1	1
6	1376	328	3	1	1

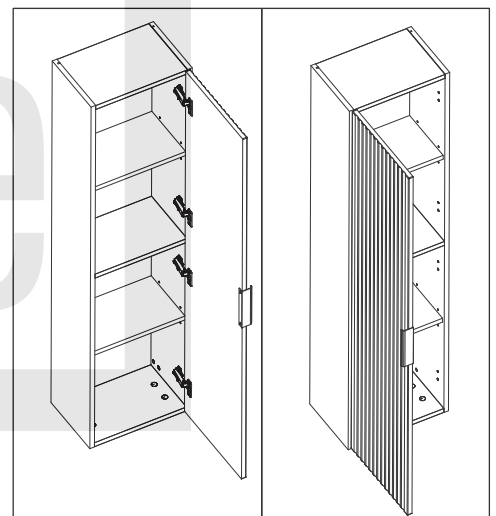
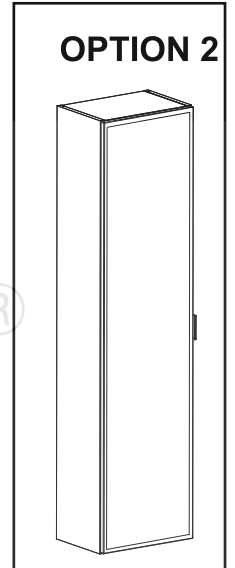
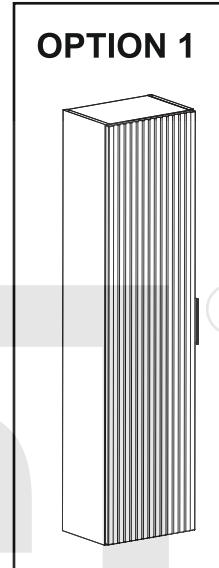
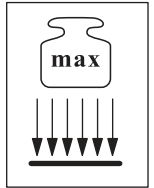
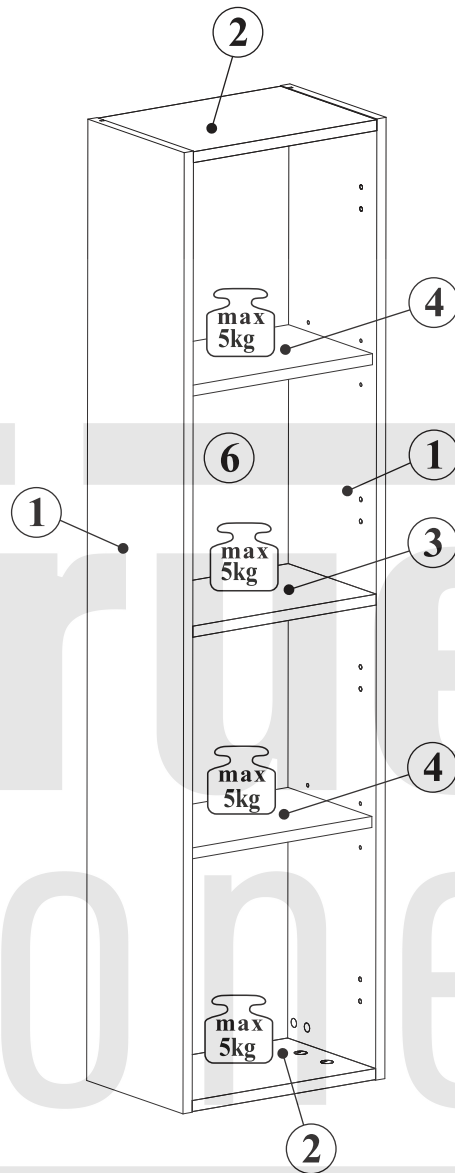
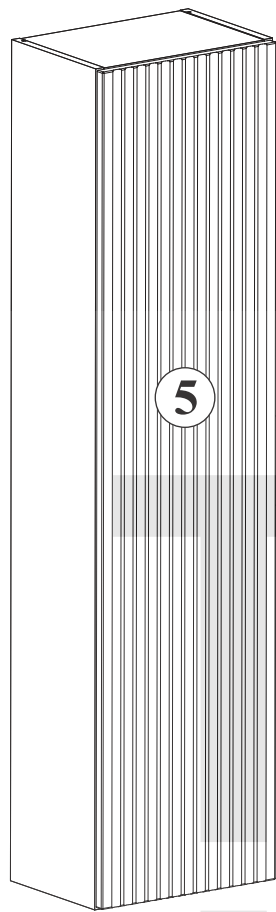
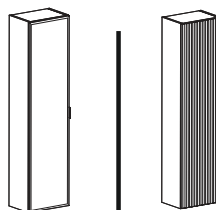

NO	Dim.			Col.-No	Qty
1	1400	236	16	1	2
2	318	235	16	1	2
3	318	212	16	1	1
4	318	204	16	1	2
5	1394	346	17	1	1
6	1376	328	3	1	1



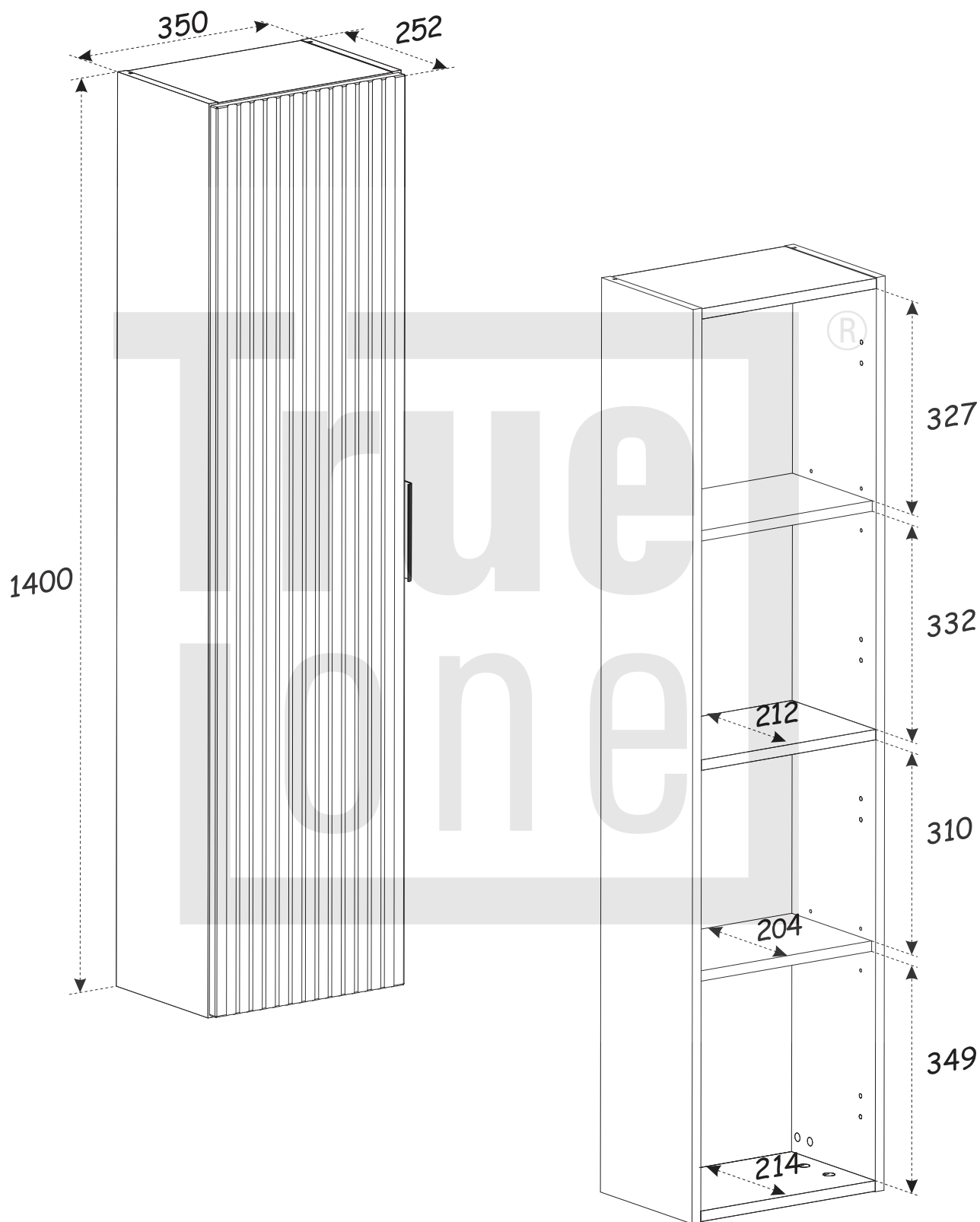



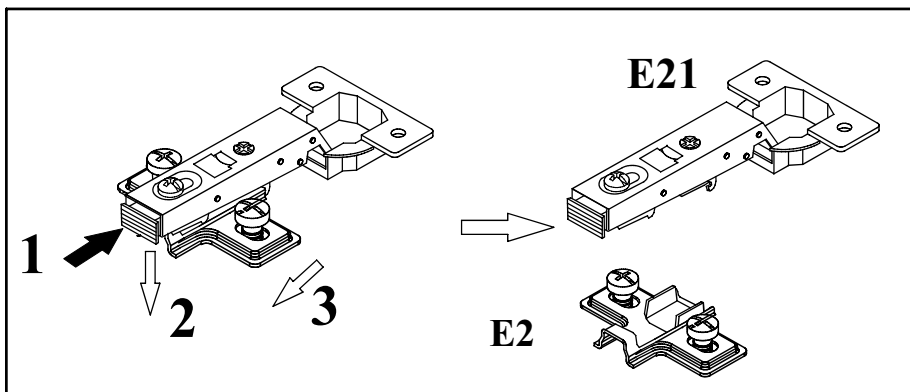
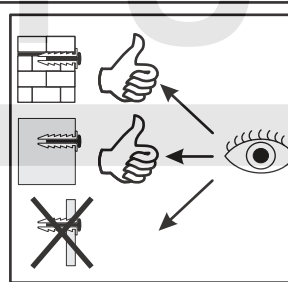
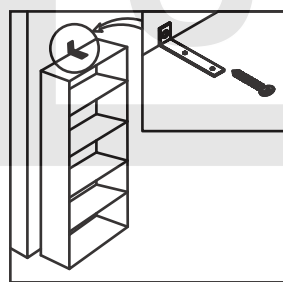
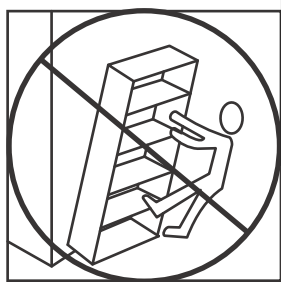
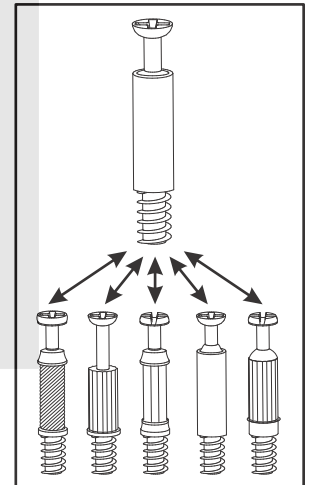
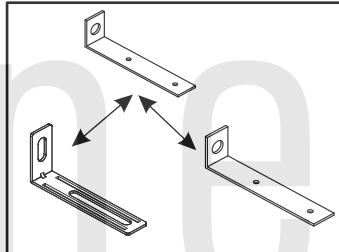
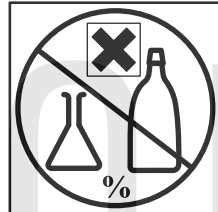
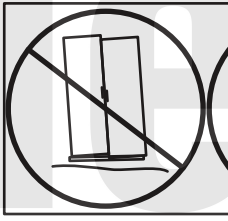
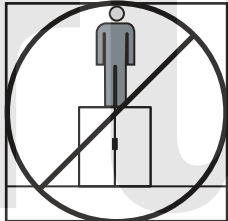
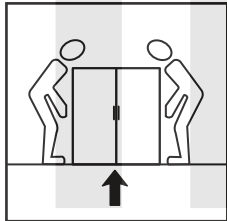
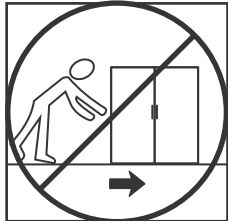
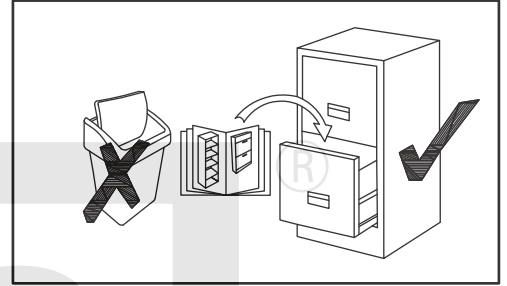
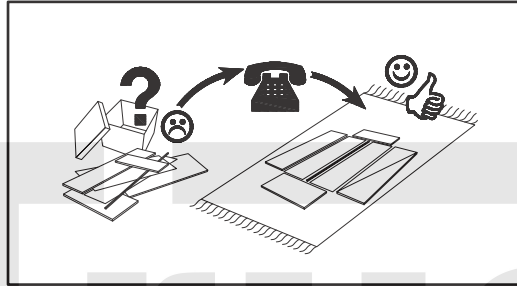
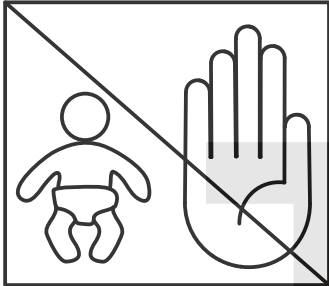
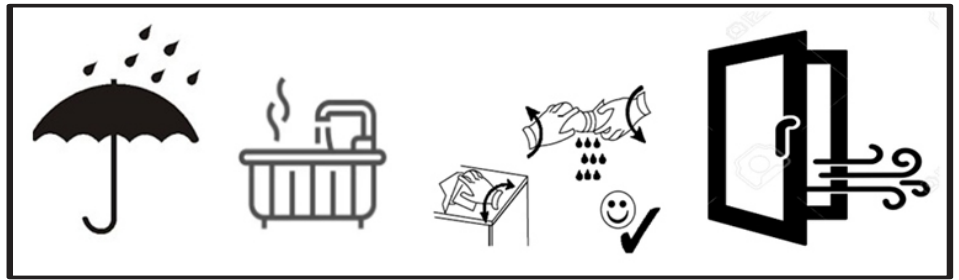
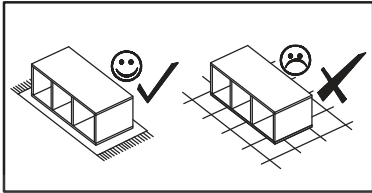
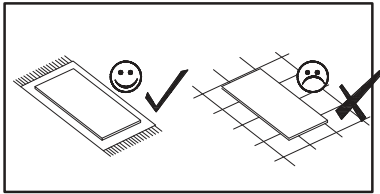



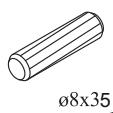
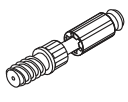

# SŁUPEK WYSOKI 1D

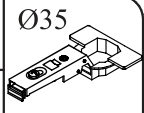
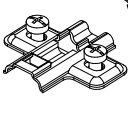

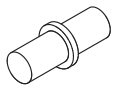
# SŁUPEK WYSOKI 1D

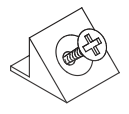
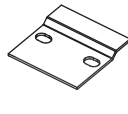

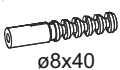
# SŁUPEK WYSOKI 1D

A1 x12  ø8x35	B4 x12 	B5 x12  ø15x12	G5 x12 	ZXP x1 	ZXL x1 
E21 x4  Ø35 H=0	E2 x4  H=0	D10 x8  USØ3,5x13	G7 x8 	Z2 x8  Ø5	Z5 x4  Ø10
S1 x8 	SZ7 x2 	SZ6 x4  ø4,5x45  ø8x40	UP13 x3  UPØ3x20	D6 x4  USØ4x30	

**OPTION 1**

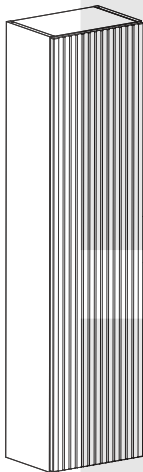

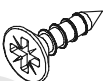
G04 x1  L-148mm.
D10 x2  USØ3,5x13

**OPTION 2**

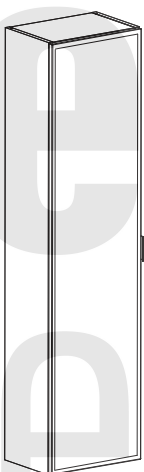

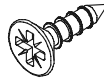

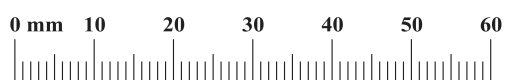
G05 x1  L-32mm.
D10 x2  USØ3,5x13

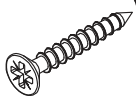

# SŁUPEK WYSOKI 1D

1

D6	
x4	USØ3,5x30

Z5	
x4	Ø10

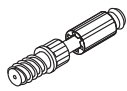
B4	
x12	

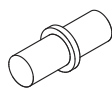
G7	
x8	

ZXP	
x1	

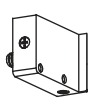
ZXL	
x1	

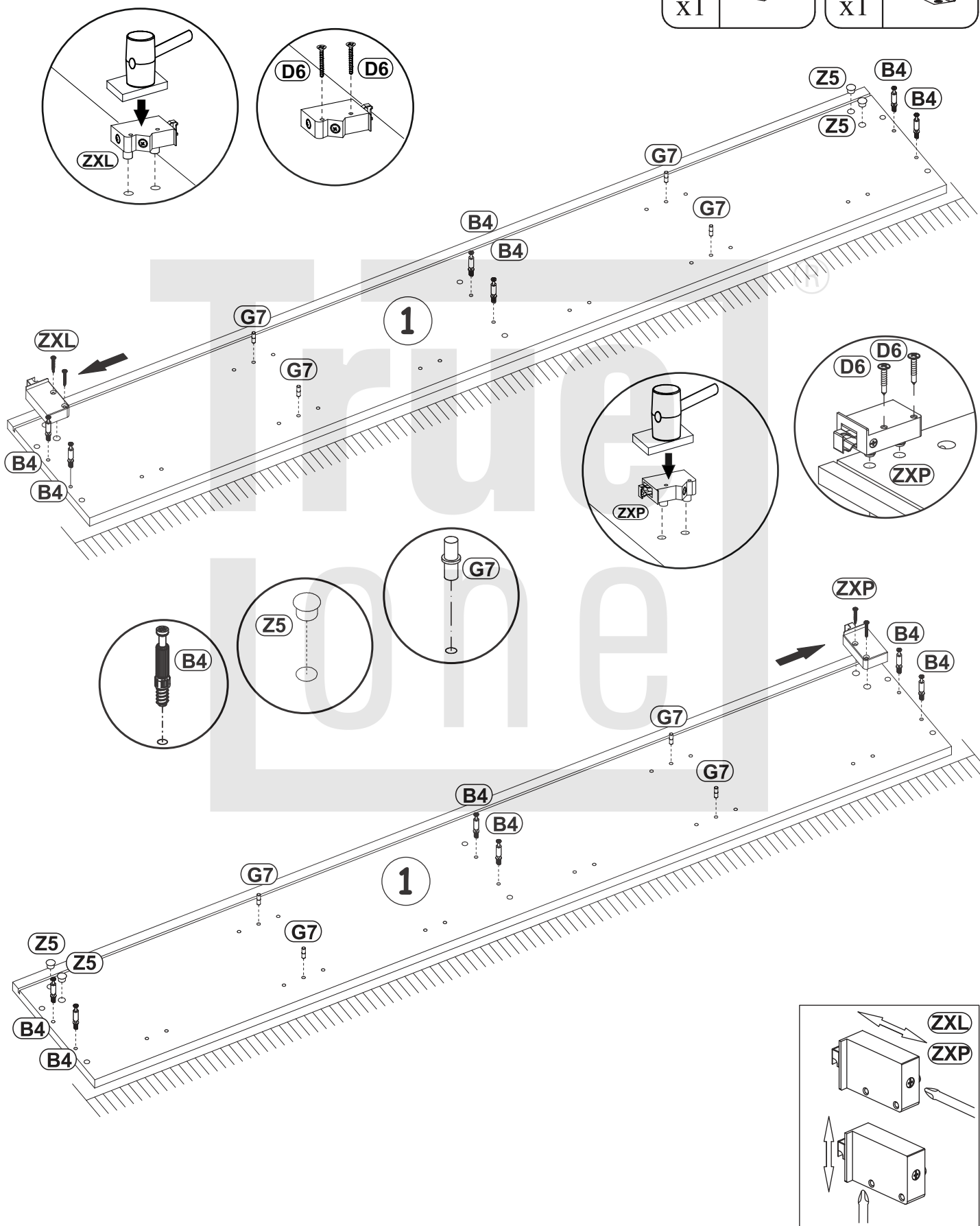

# SŁUPEK WYSOKI 1D

2

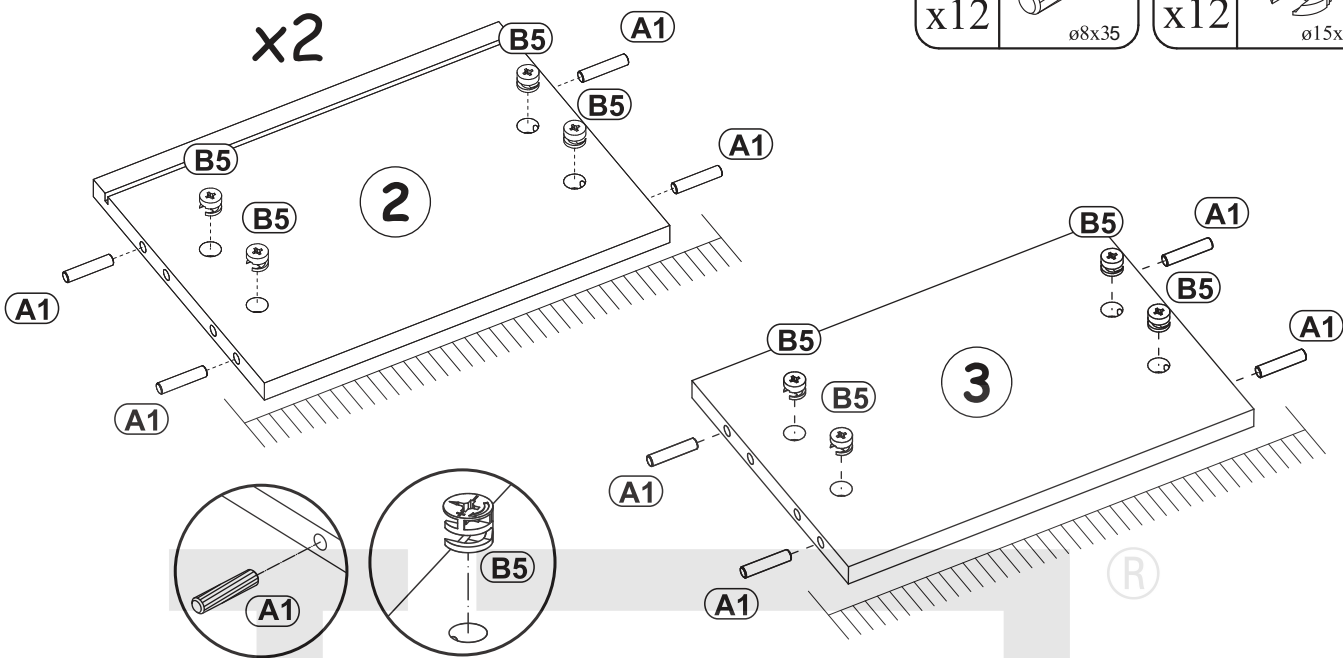

A1		B5	
x12	ø8x35	x12	ø15x12

3

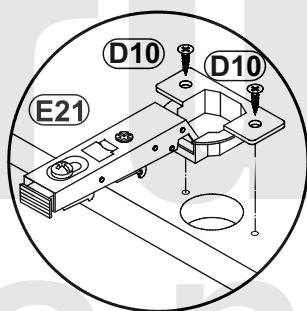
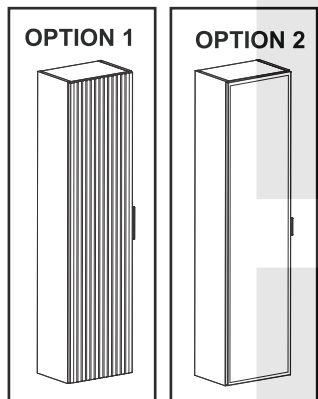

D10		E21	
x8	USØ3,5x13	x4	Ø35 H=0

5  
OPTION 1

5  
OPTION 2

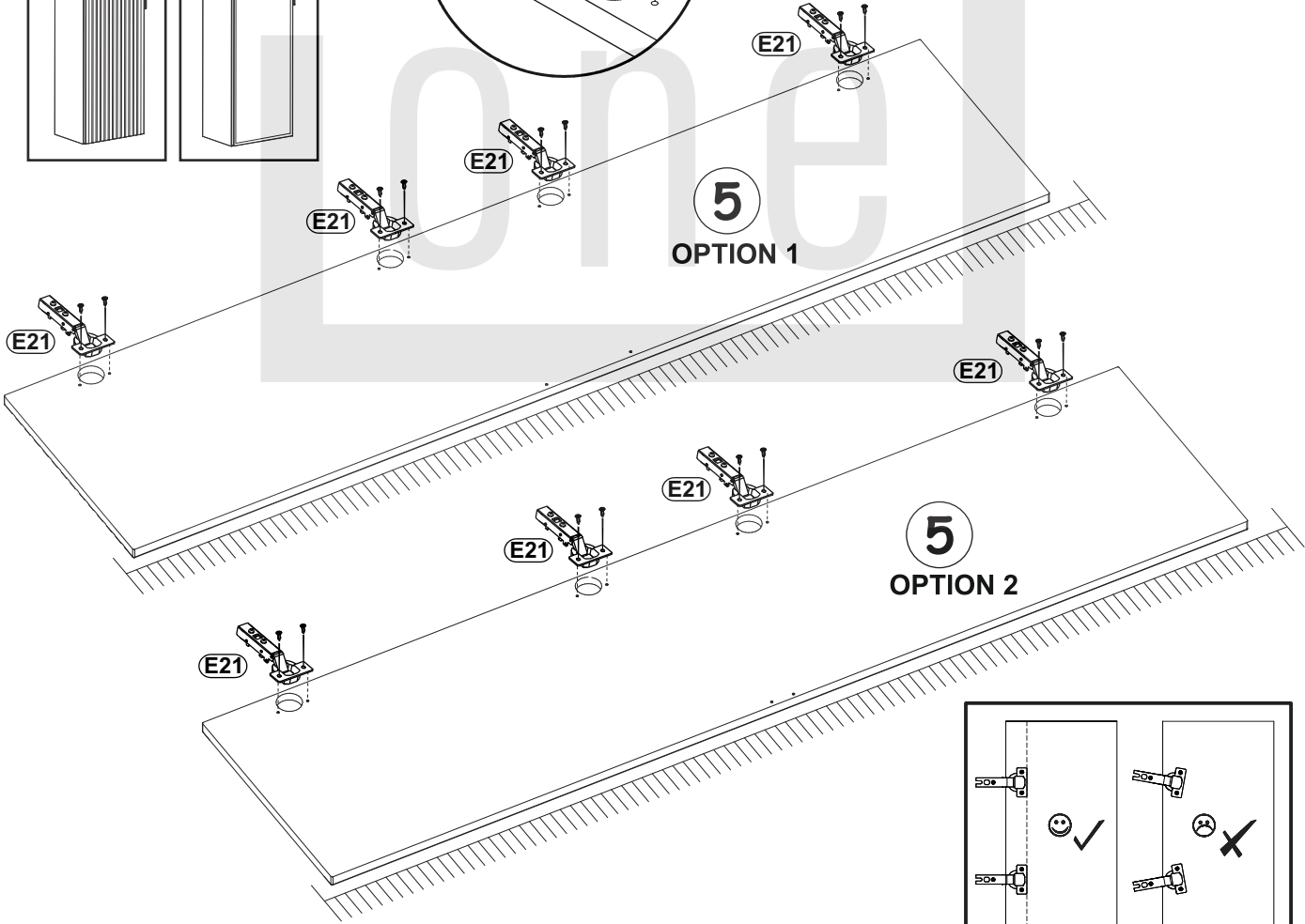

# SŁUPEK WYSOKI 1D

4

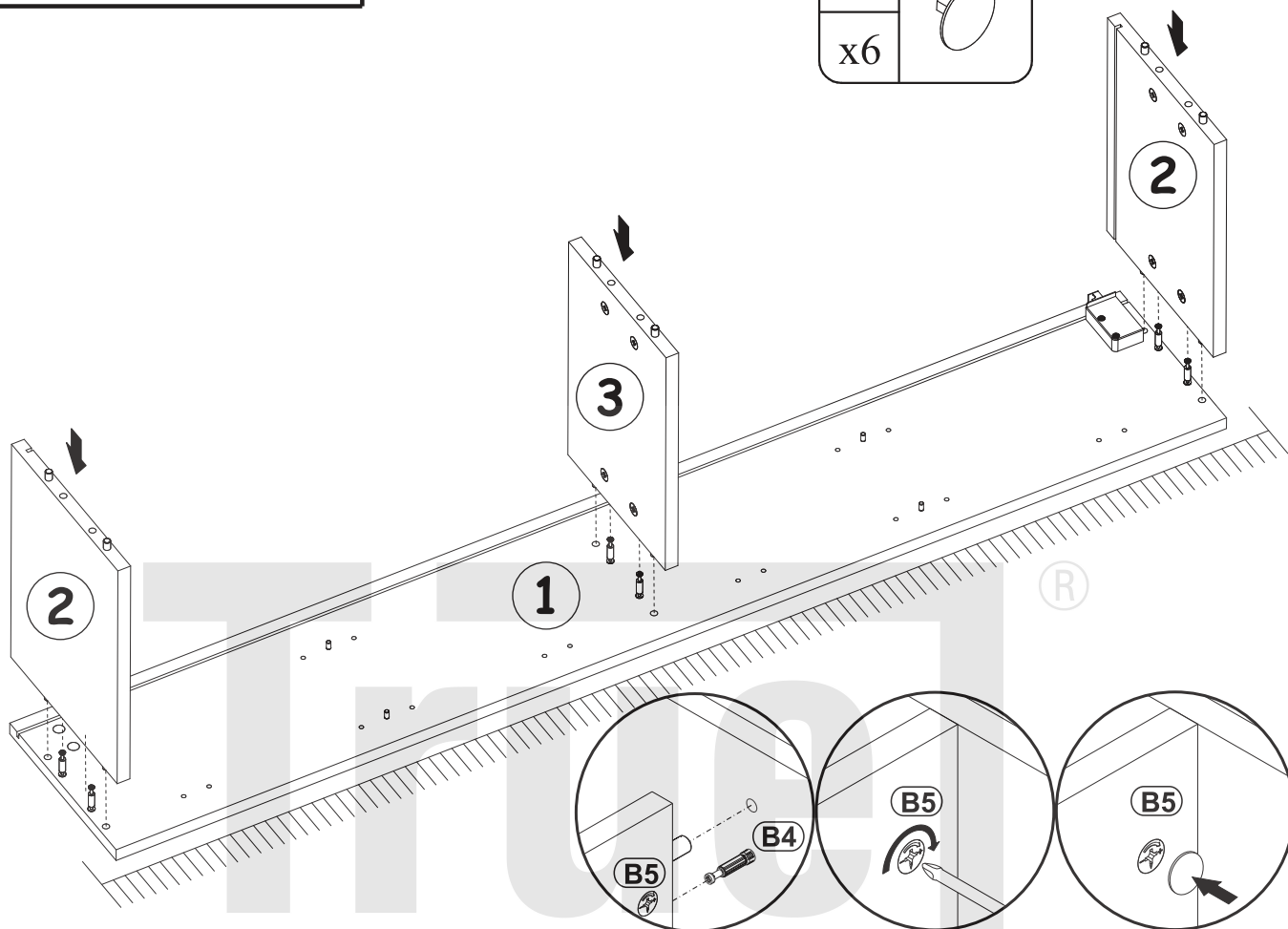
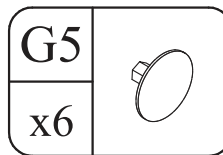

5

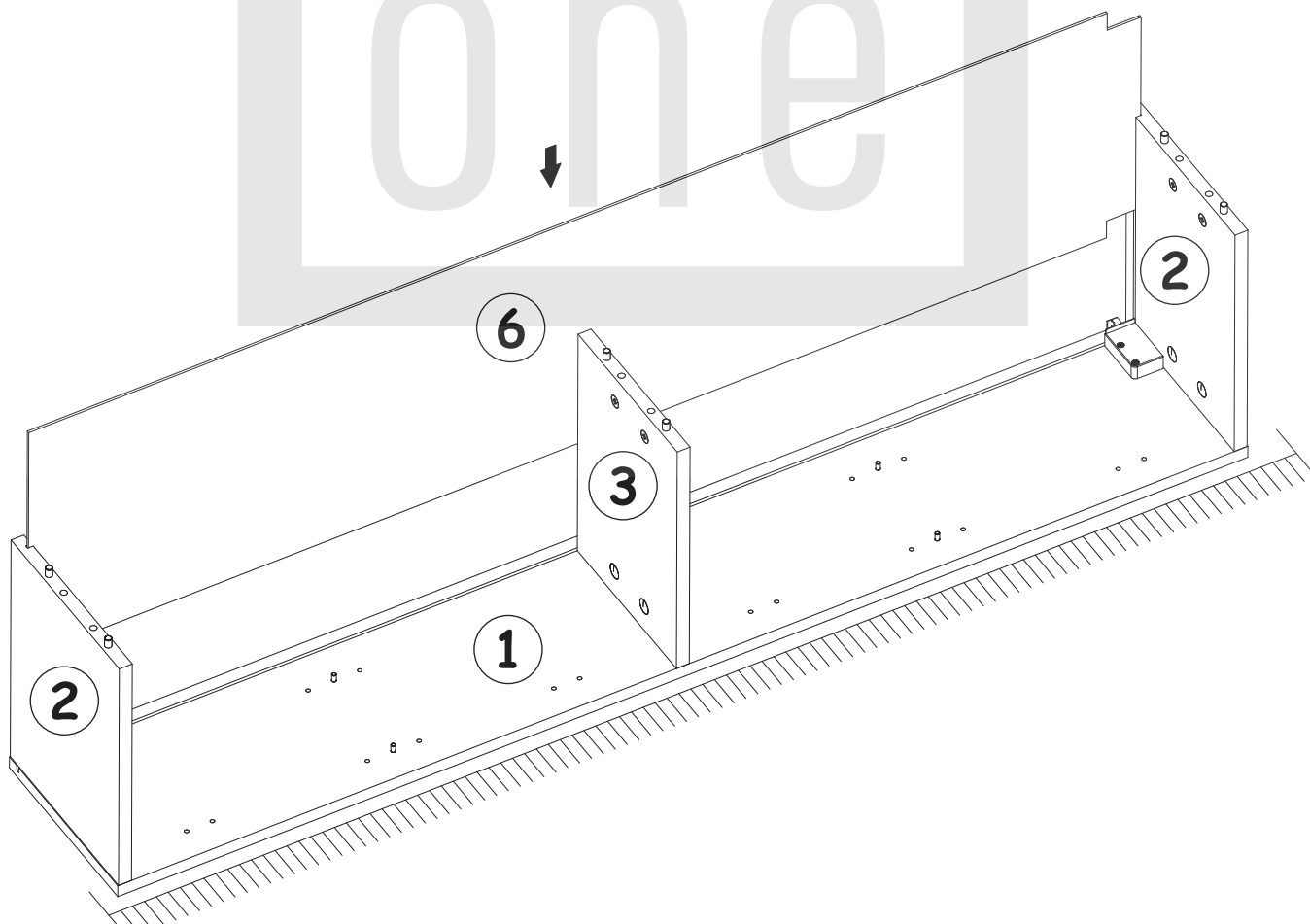

# SŁUPEK WYSOKI 1D

6

G5	
x6	

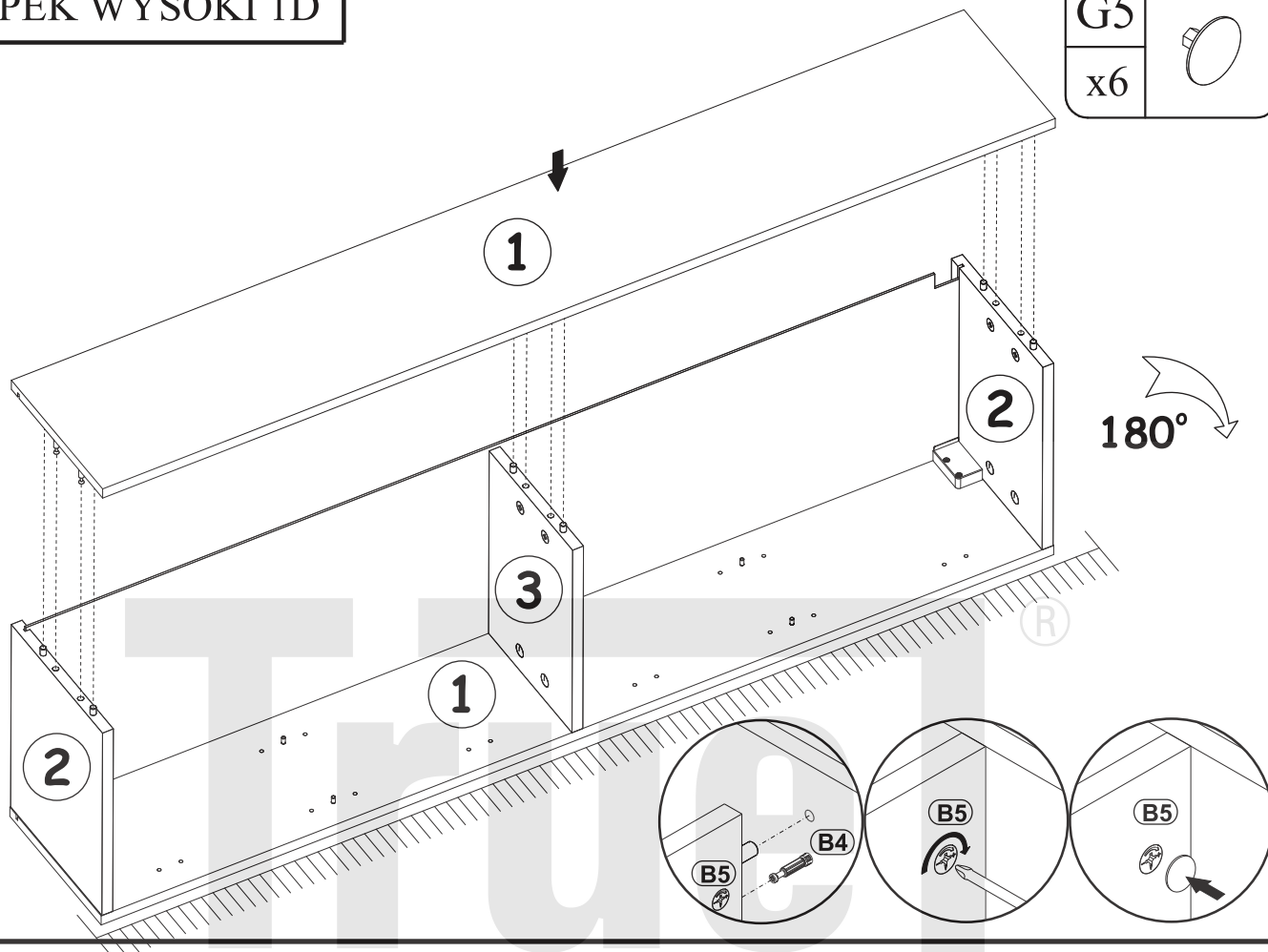

7

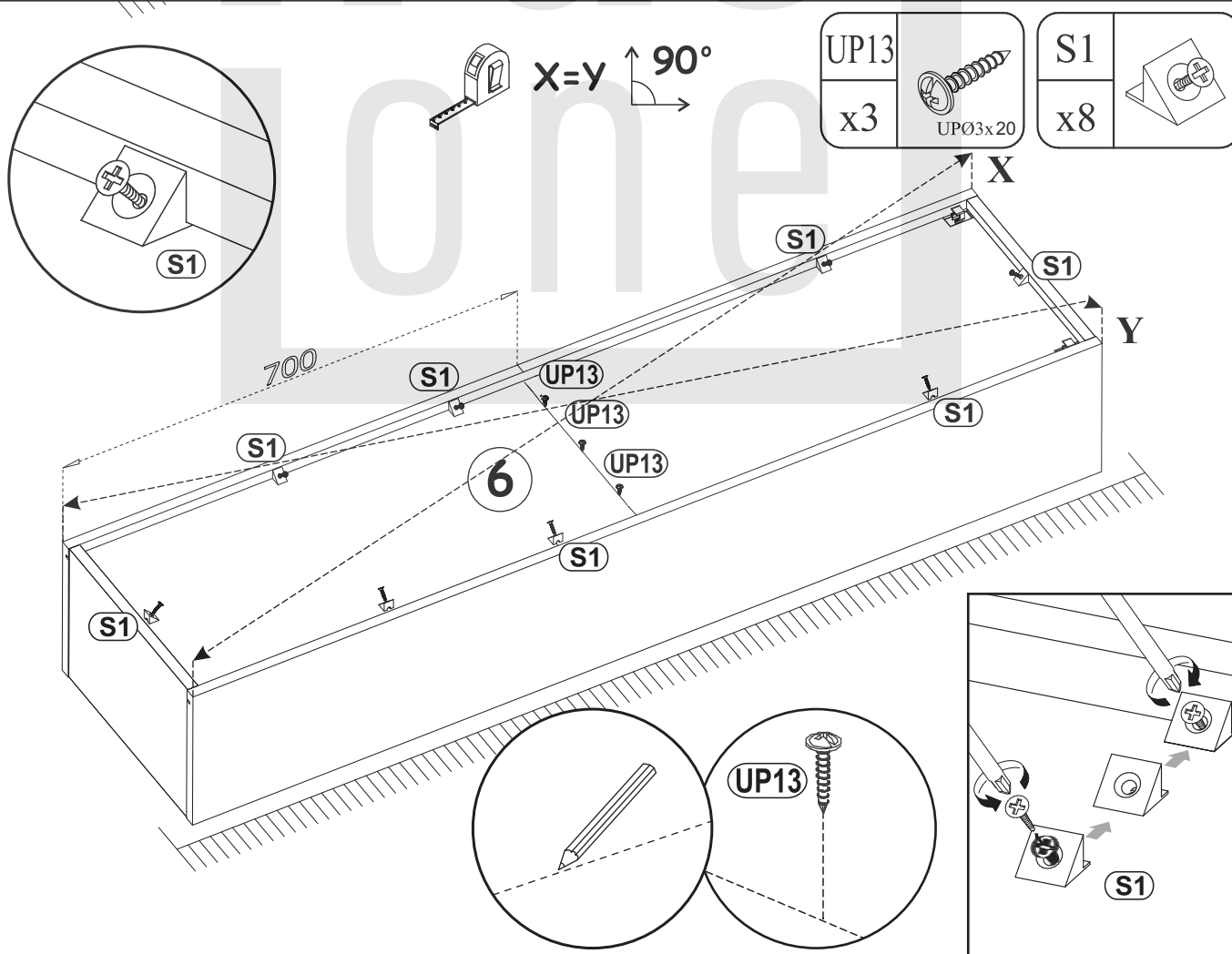



# SŁUPEK WYSOKI 1D

SZ6	ø4,5x45
x4	ø8x40

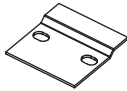
SZ7	
x2	

8

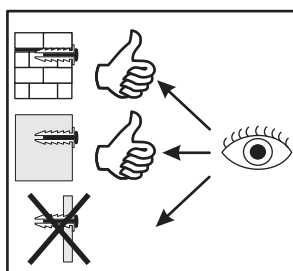
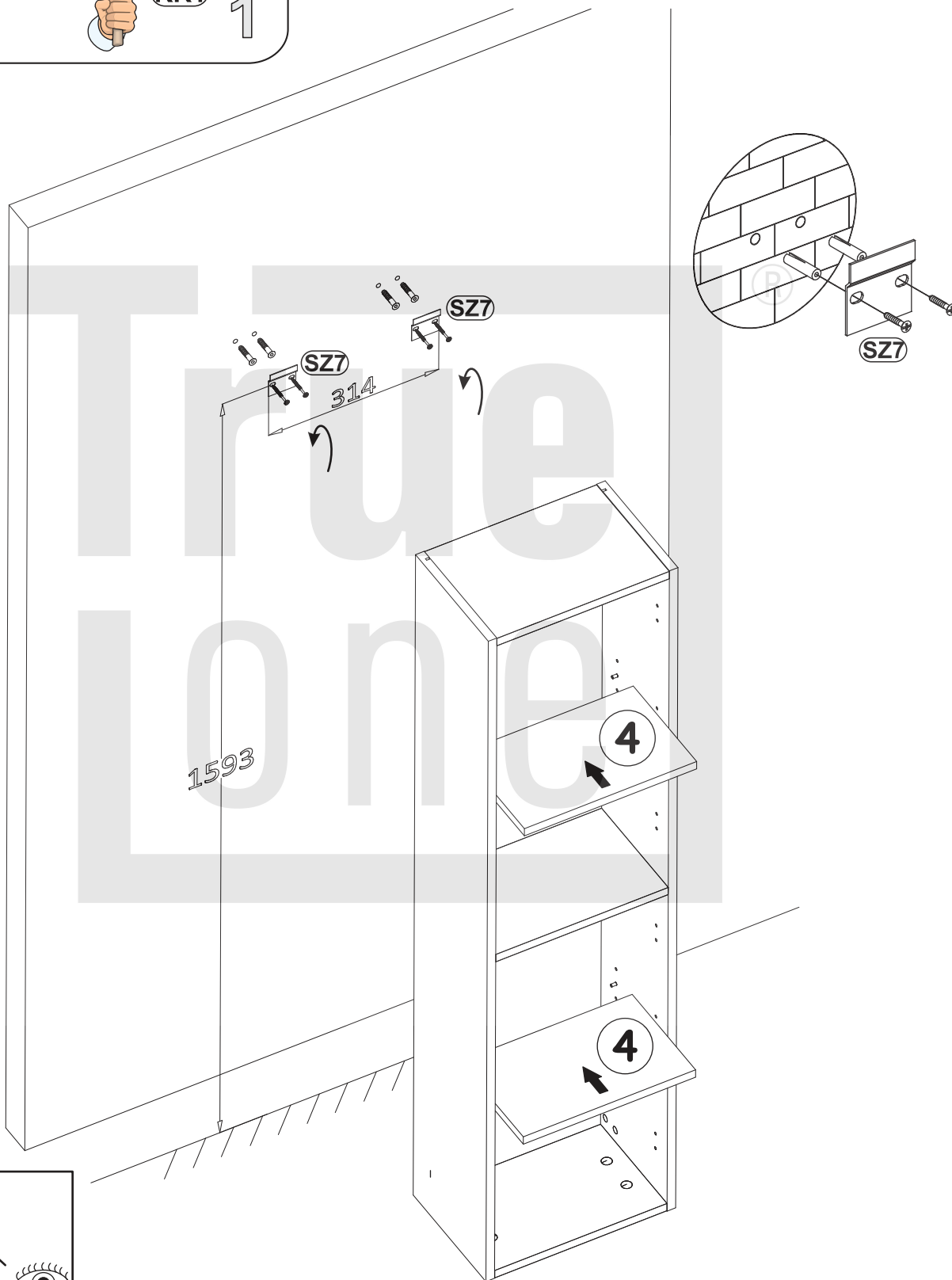
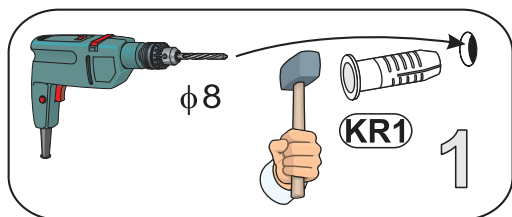

**SŁUPEK WYSOKI 1D**

**9-11**

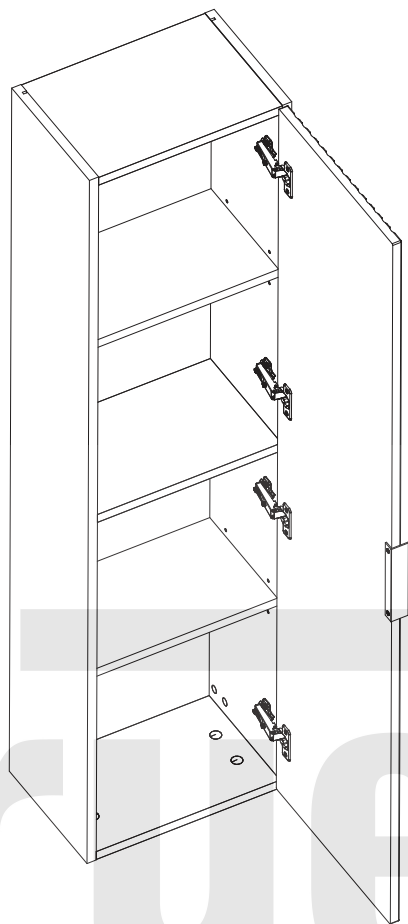

**OPTION 1**

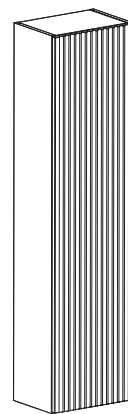

**OPTION 2**

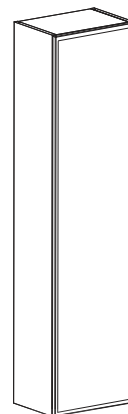

**12-14**

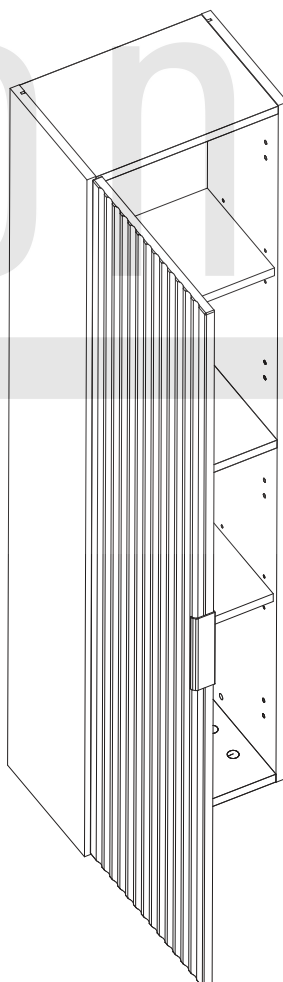

**OPTION 1**

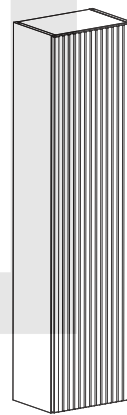

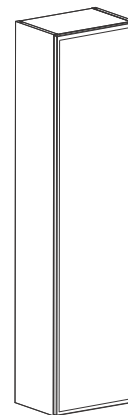

**OPTION 2**

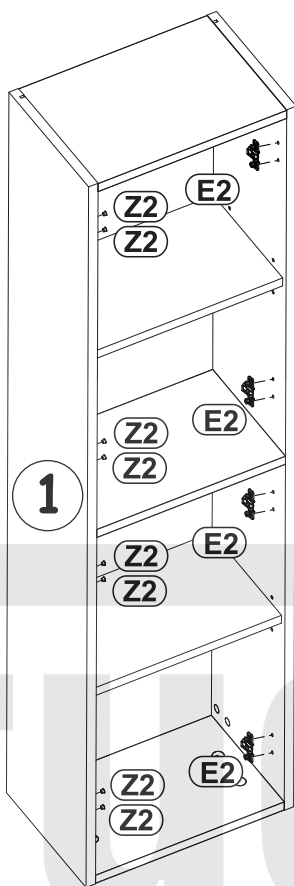
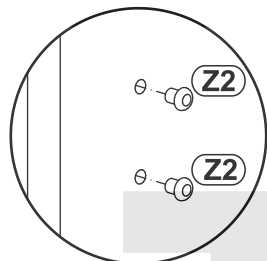
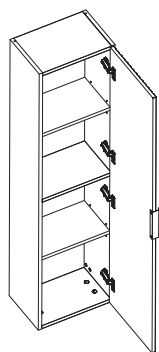

# SŁUPEK WYSOKI 1D

9

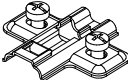

Z2		E2	
x8	Ø5	x4	H=0

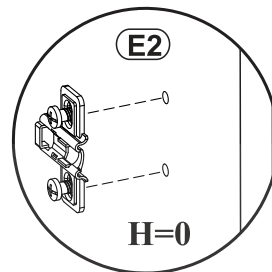

10

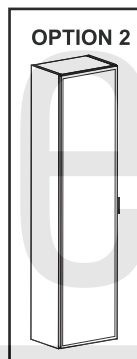
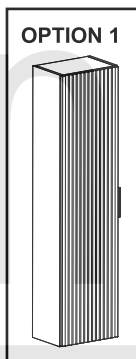
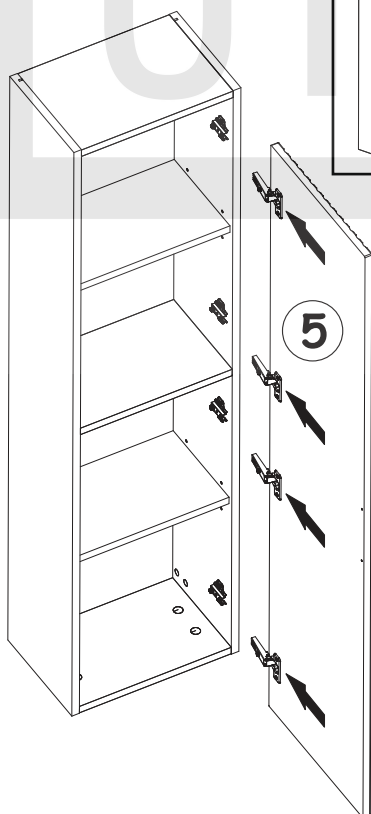
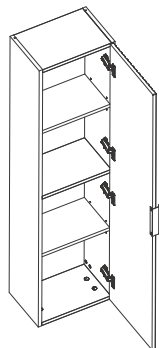

# ŚLUPEK WYSOKI 1D

## 11

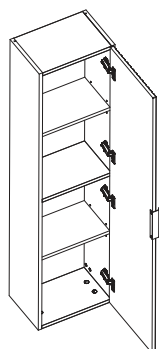

### OPTION 1

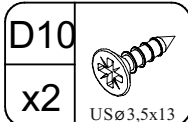
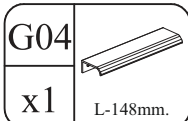
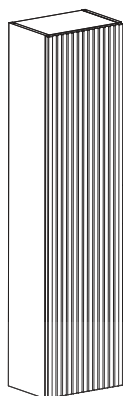

### OPTION 2

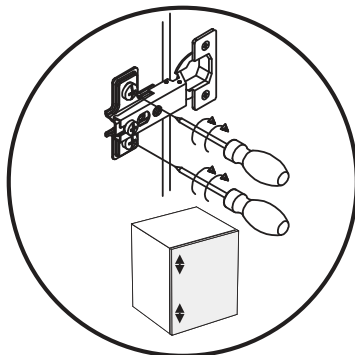
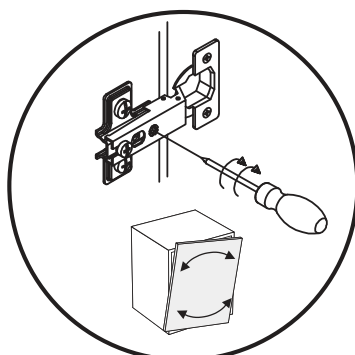
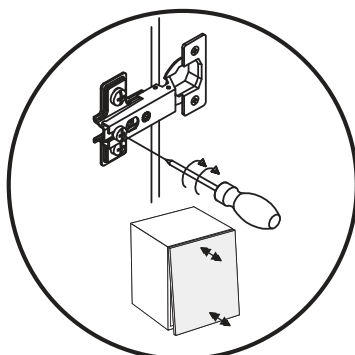
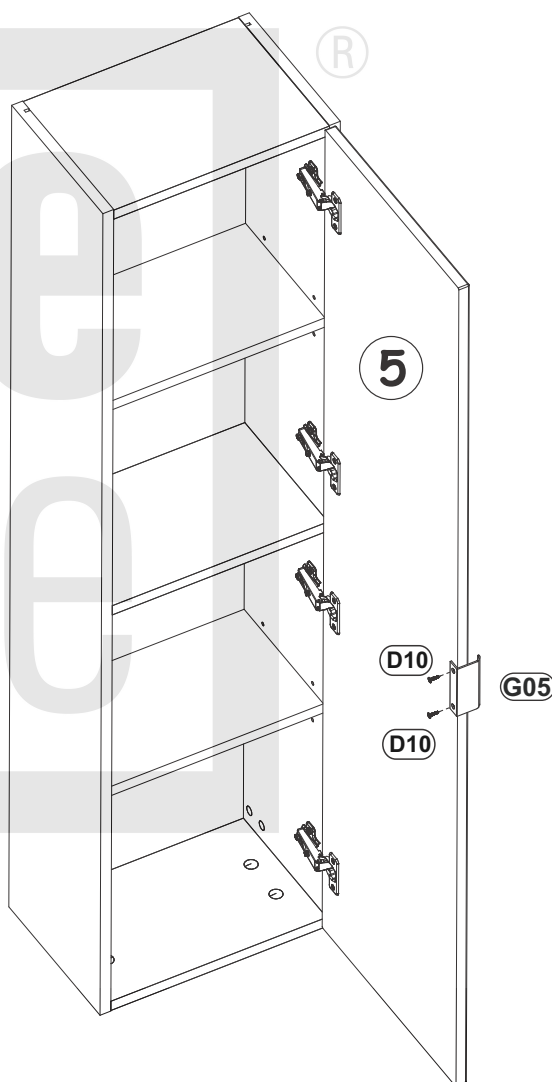
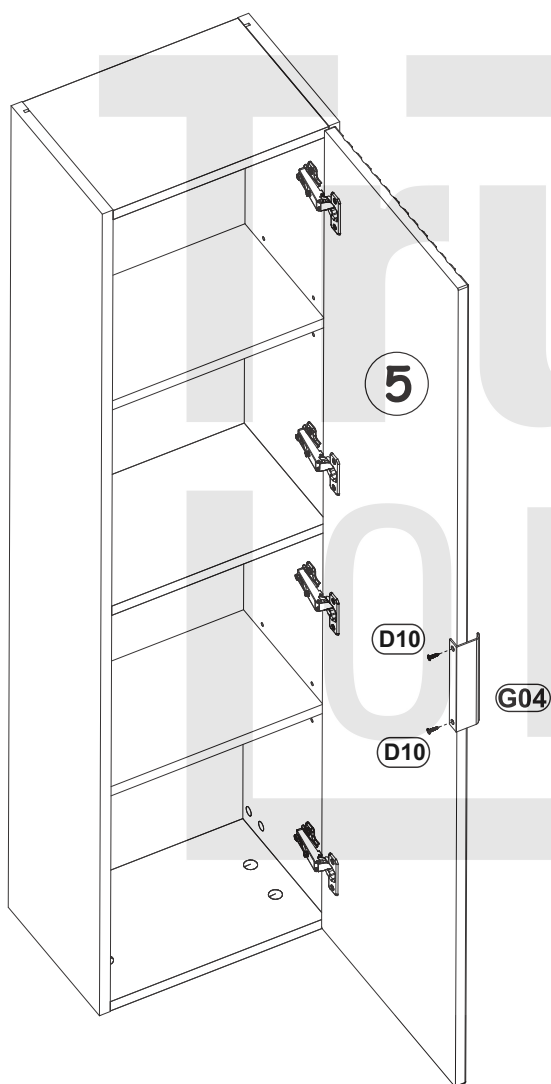
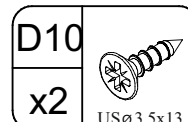
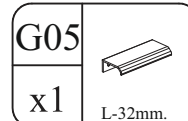
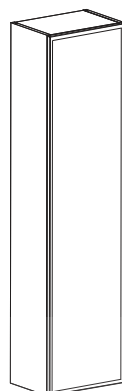

# SŁUPEK WYSOKI 1D

12

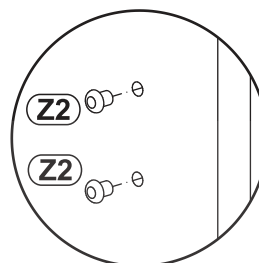
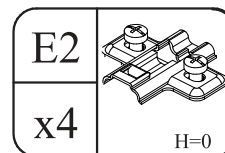
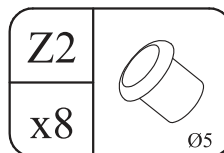
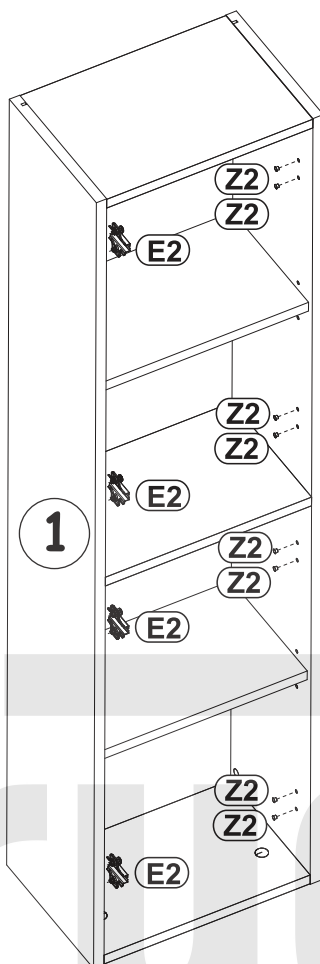
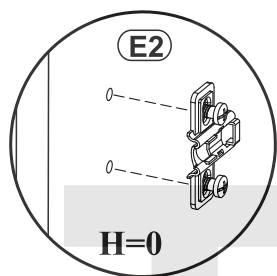
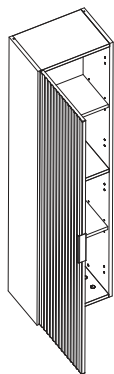

13

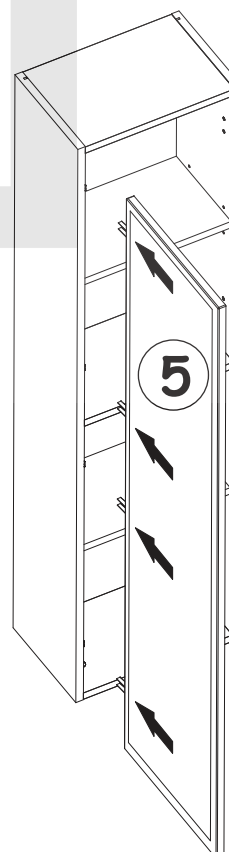
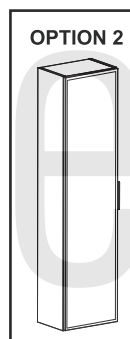
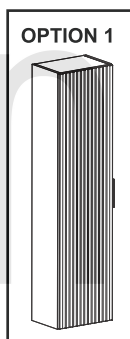
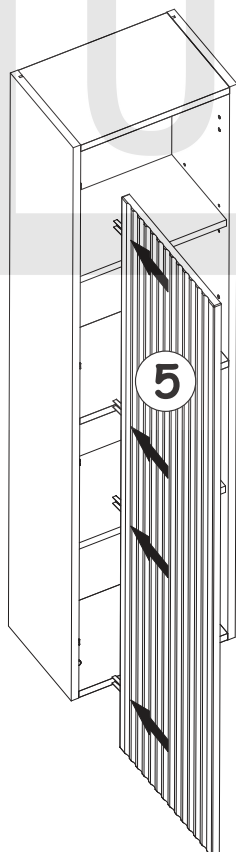
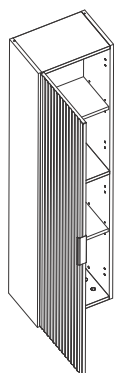

# SŁUPEK WYSOKI 1D

14

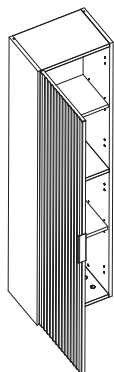

## OPTION 1

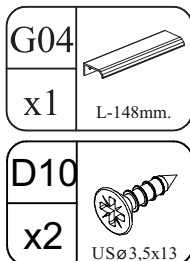
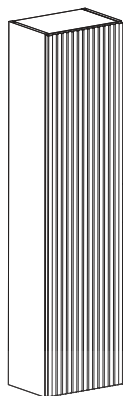

## OPTION 2

