

BLAT 140 CM BL854, 89-140-B
 BLAT 160 CM BL855, 89-160-B
 BLAT 180 CM BL856, 89-180-B

SILIKON

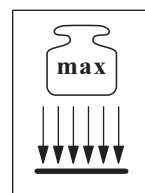

x2

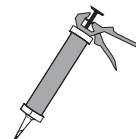
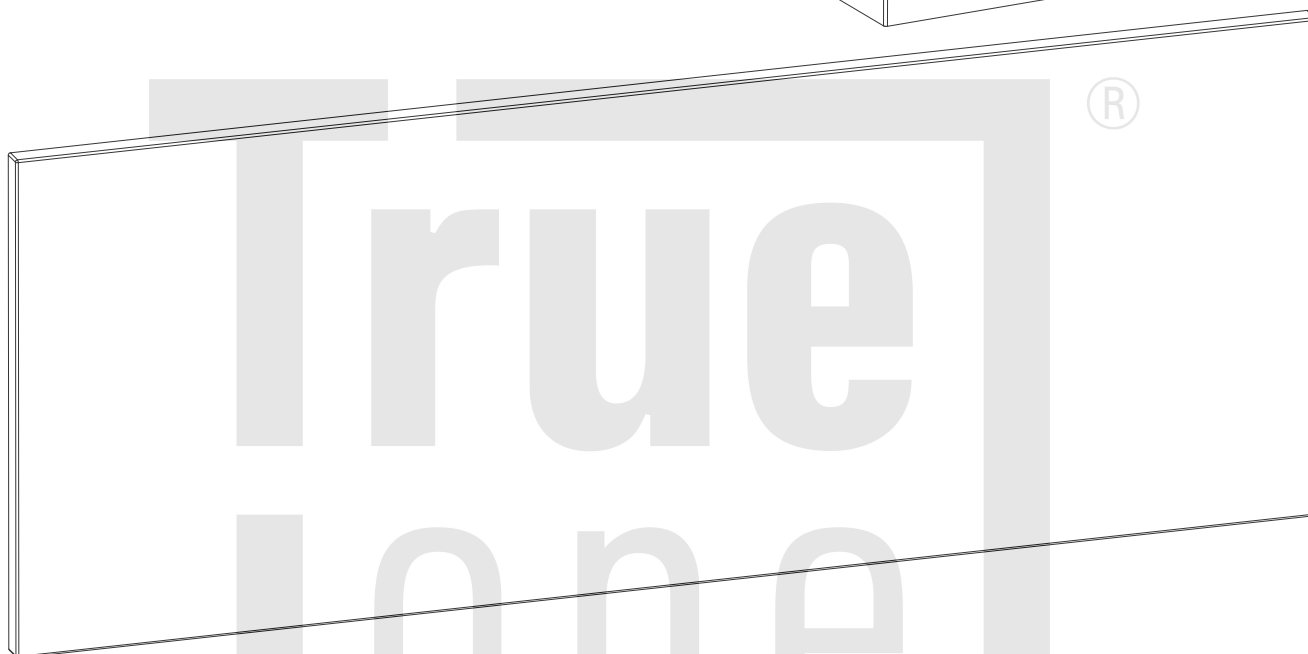
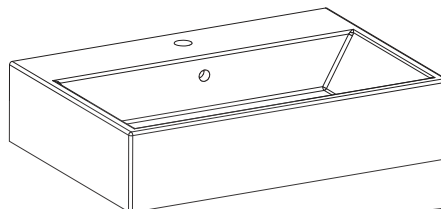

BLAT 140 CM BI854, 89-140-B

NO	Dim. [mm]			Col.-No	Qty
1	1408	465	22	1	1

BLAT 160 CM BL855, 89-160-B

NO	Dim. [mm]			Col.-No	Qty
1	1608	465	22	1	1

BLAT 180 CM BI856, 89-180-B

NO	Dim. [mm]			Col.-No	Qty
1	1808	465	22	1	1



90 min

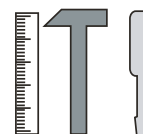

BLAT 140 CM BL854, 89-140-B
BLAT 160 CM BL855, 89-160-B
BLAT 180 CM BL856, 89-180-B

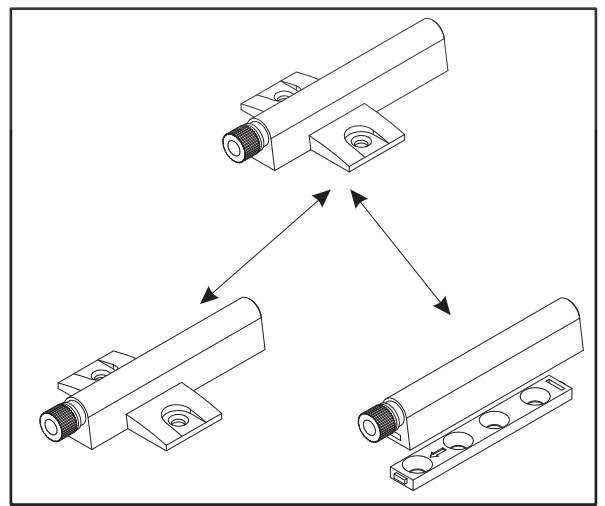
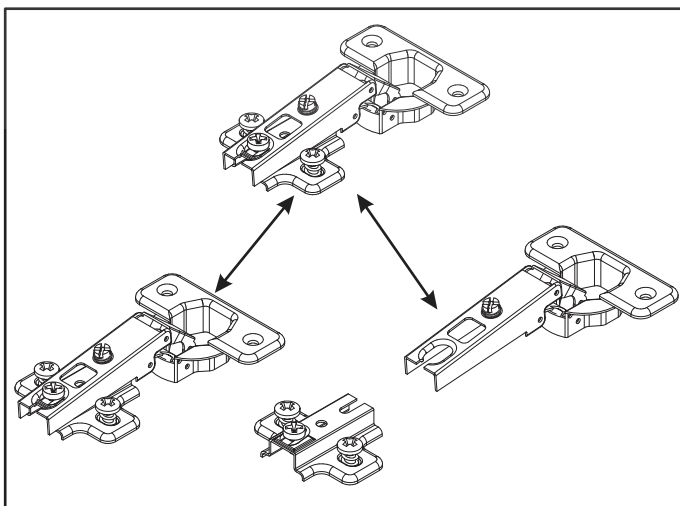
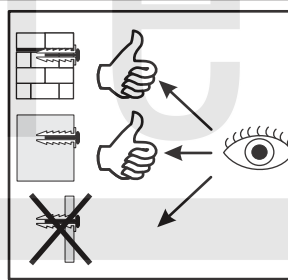
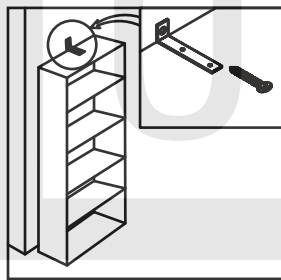
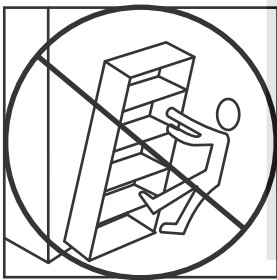
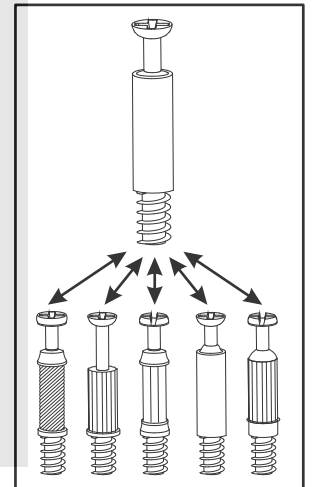
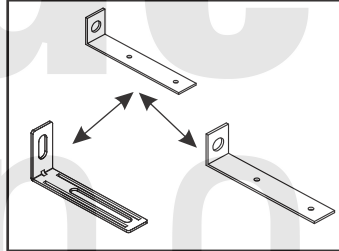
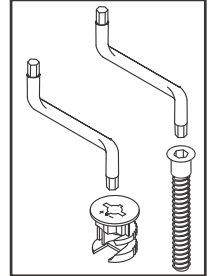
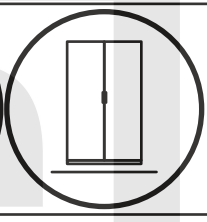
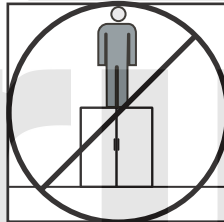
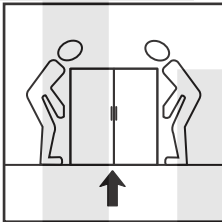
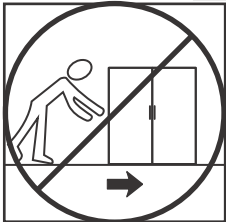
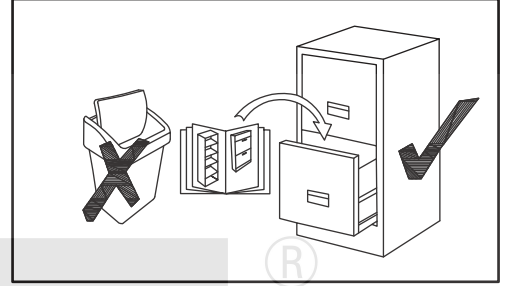
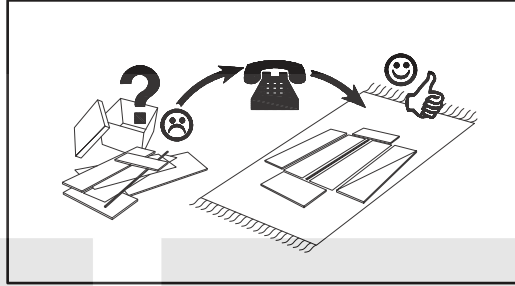
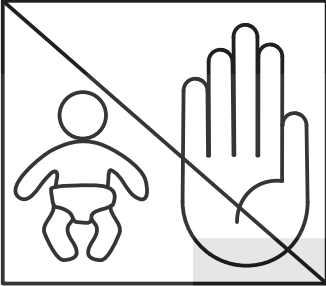
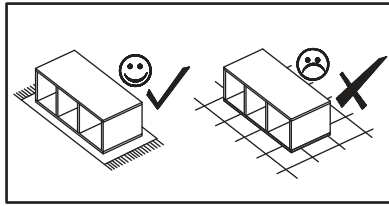
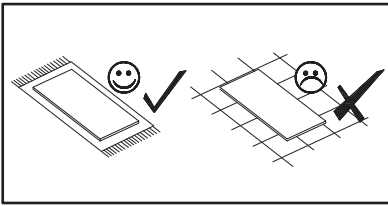

BLAT 140 CM BL854, 89-140-B
BLAT 160 CM BL855, 89-160-B
BLAT 180 CM BL856, 89-180-B

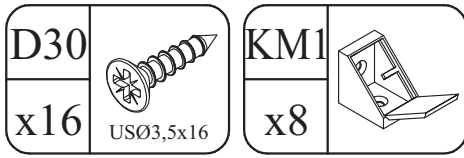

True one[®]

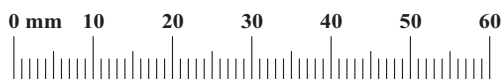

BLAT 140 CM BL854, 89-140-B
BLAT 160 CM BL855, 89-160-B
BLAT 180 CM BL856, 89-180-B

SZAFKA P./UM 2SZ 82-__0-B-2S

1

x2

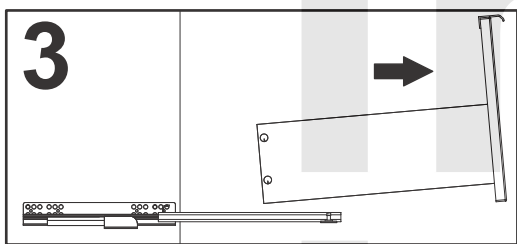
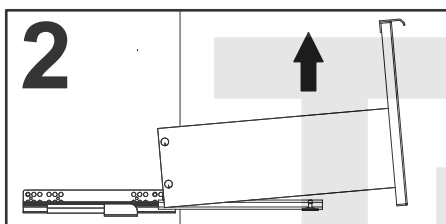
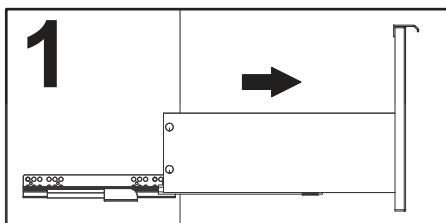
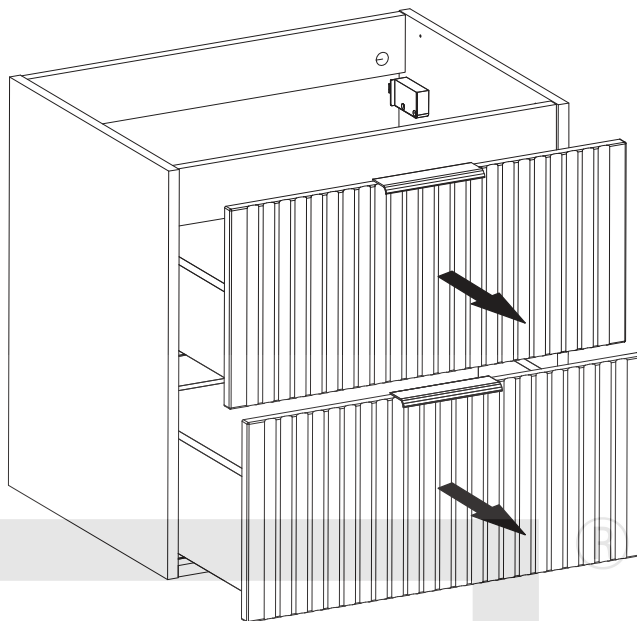

2

SZAFKA OTWARTA 81-__-A

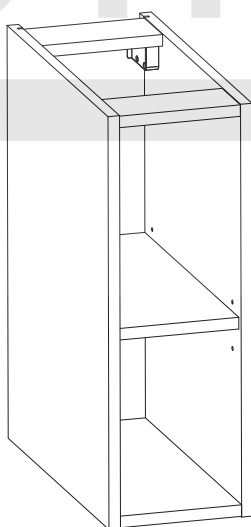

BLAT 140 CM BL854, 89-140-B
BLAT 160 CM BL855, 89-160-B
BLAT 180 CM BL856, 89-180-B

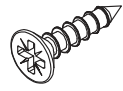
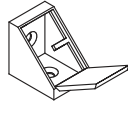
D30		KM1	
x8	USØ3,5x16	x8	

3

x2

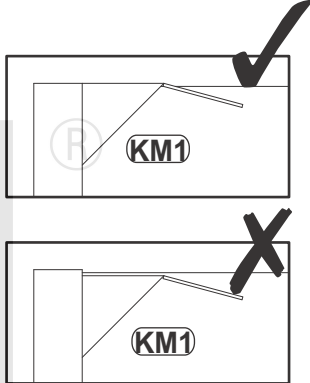
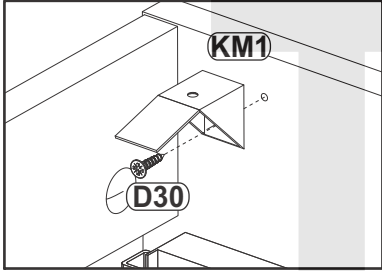
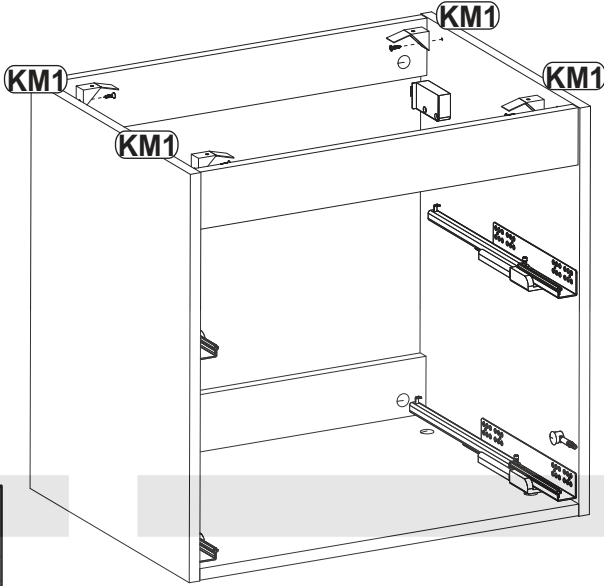

4

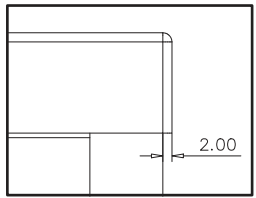
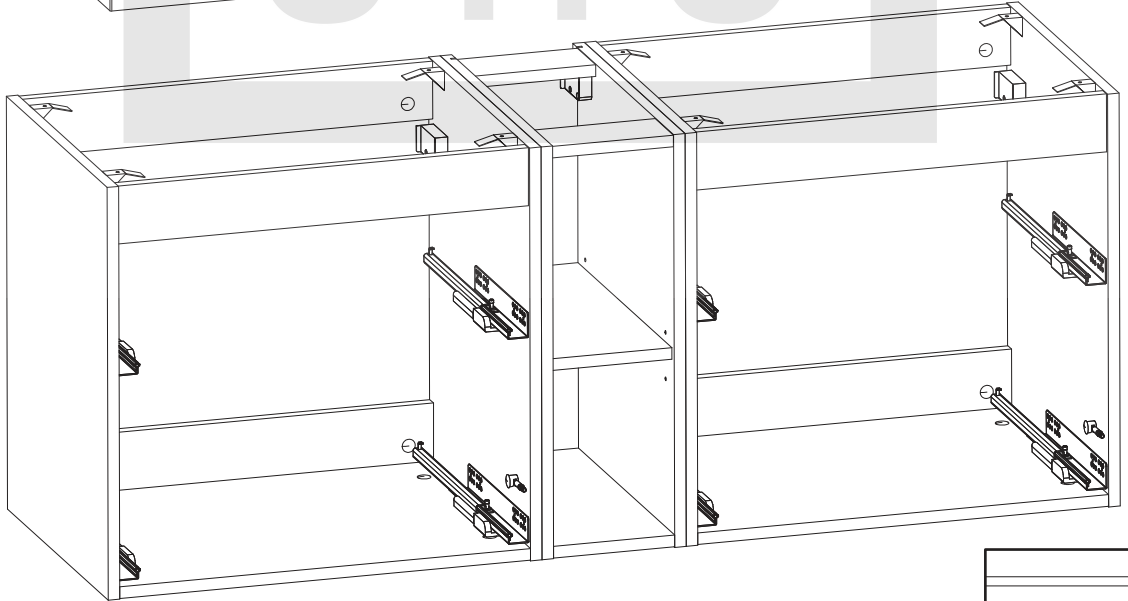
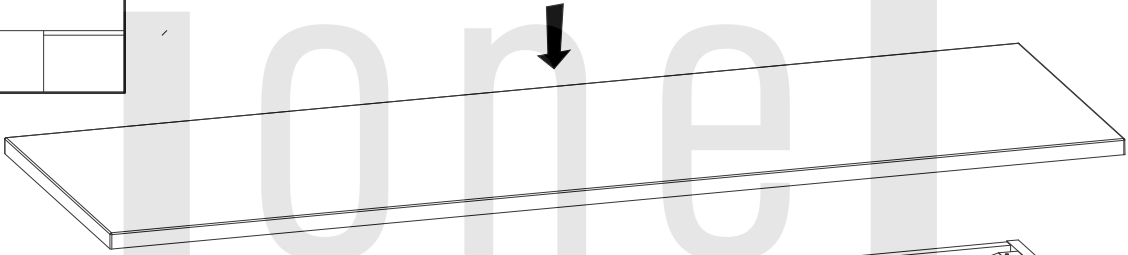
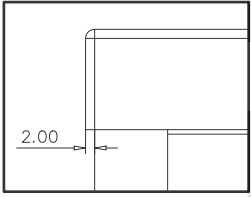

BLAT 140 CM BL854, 89-140-B
BLAT 160 CM BL855, 89-160-B
BLAT 180 CM BL856, 89-180-B

D30
x8
USØ3,5x16

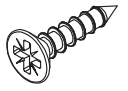

5

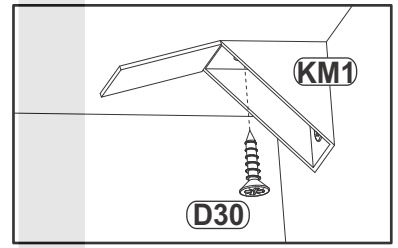
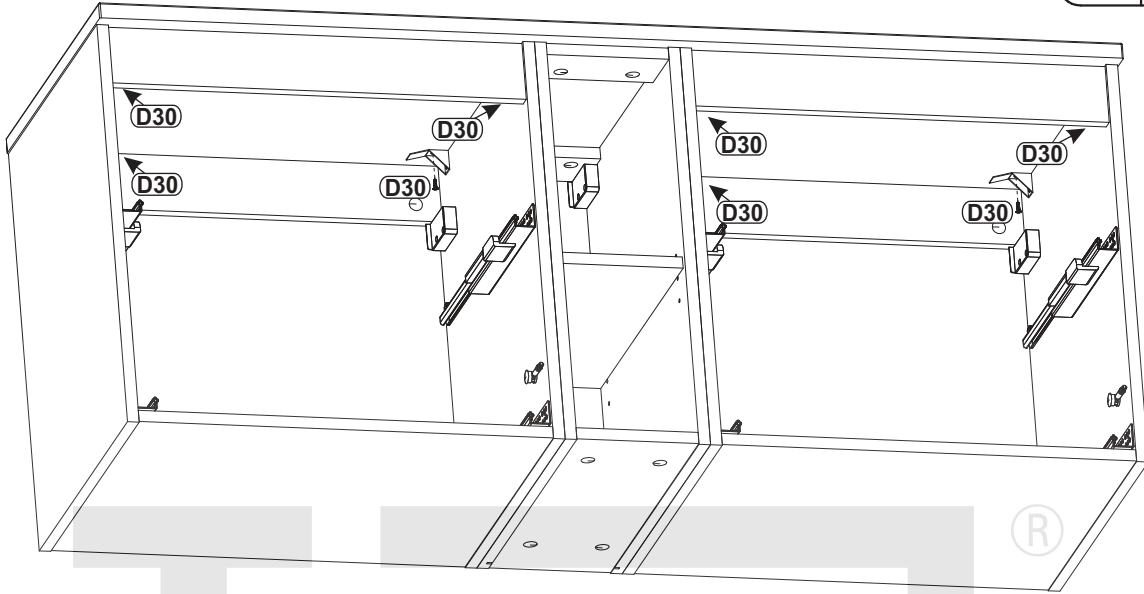

6

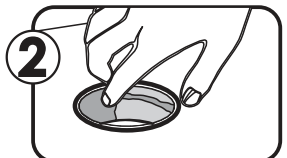
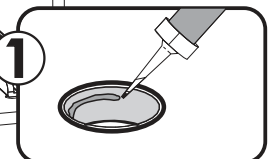
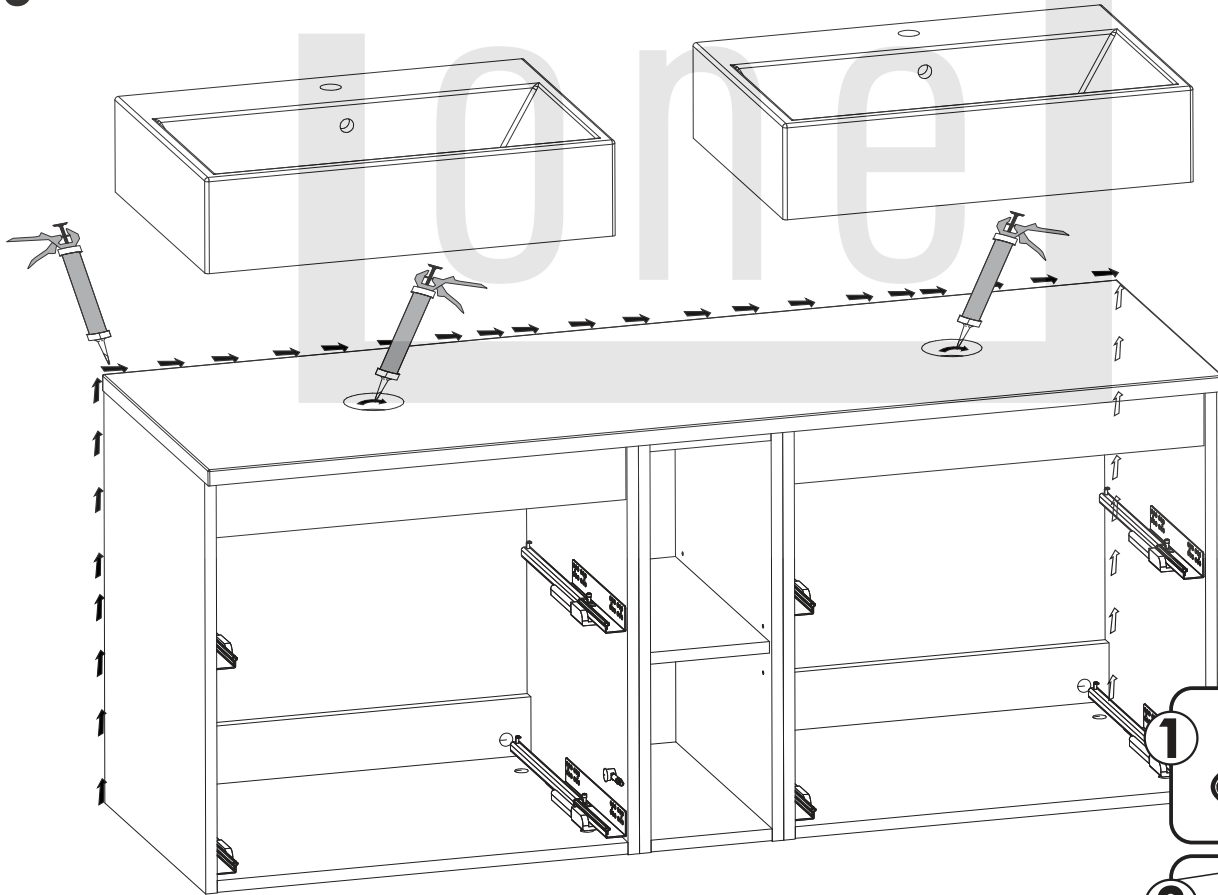

BLAT 140 CM BL854, 89-140-B
BLAT 160 CM BL855, 89-160-B
BLAT 180 CM BL856, 89-180-B

7

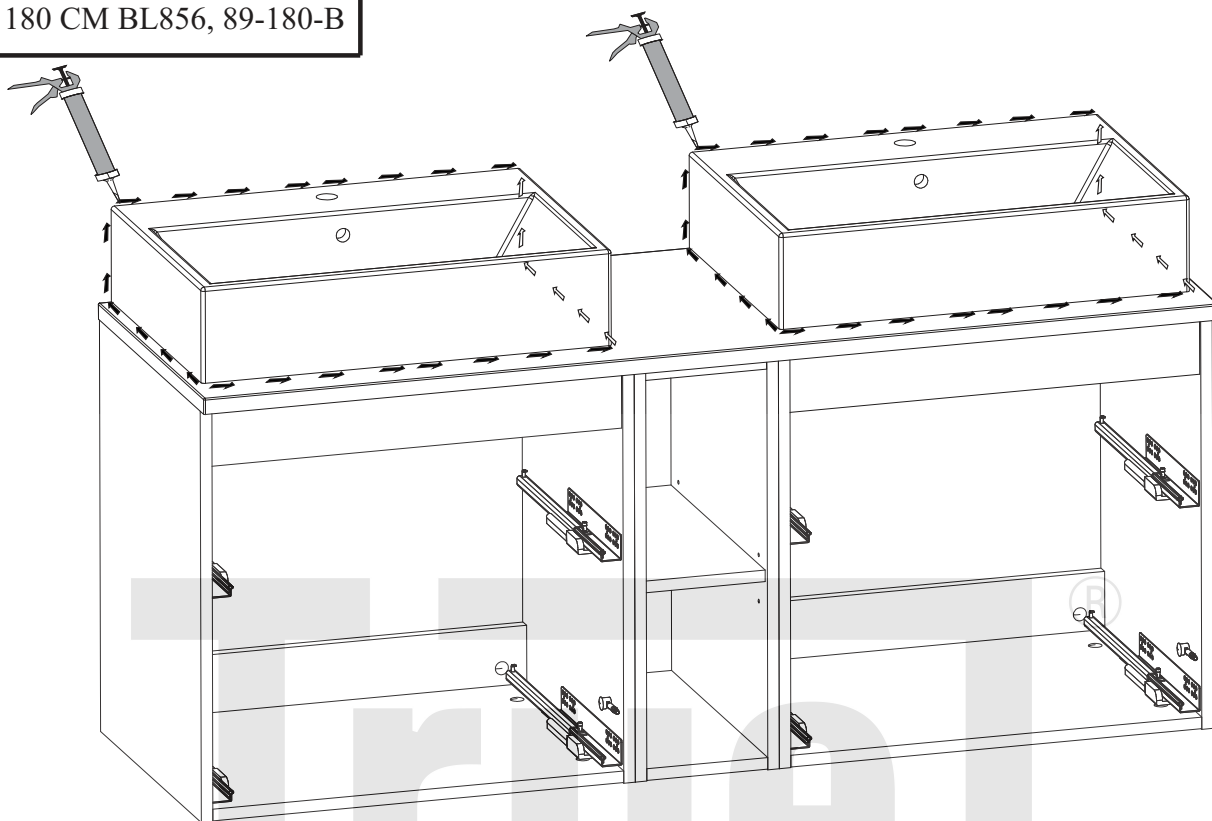

8

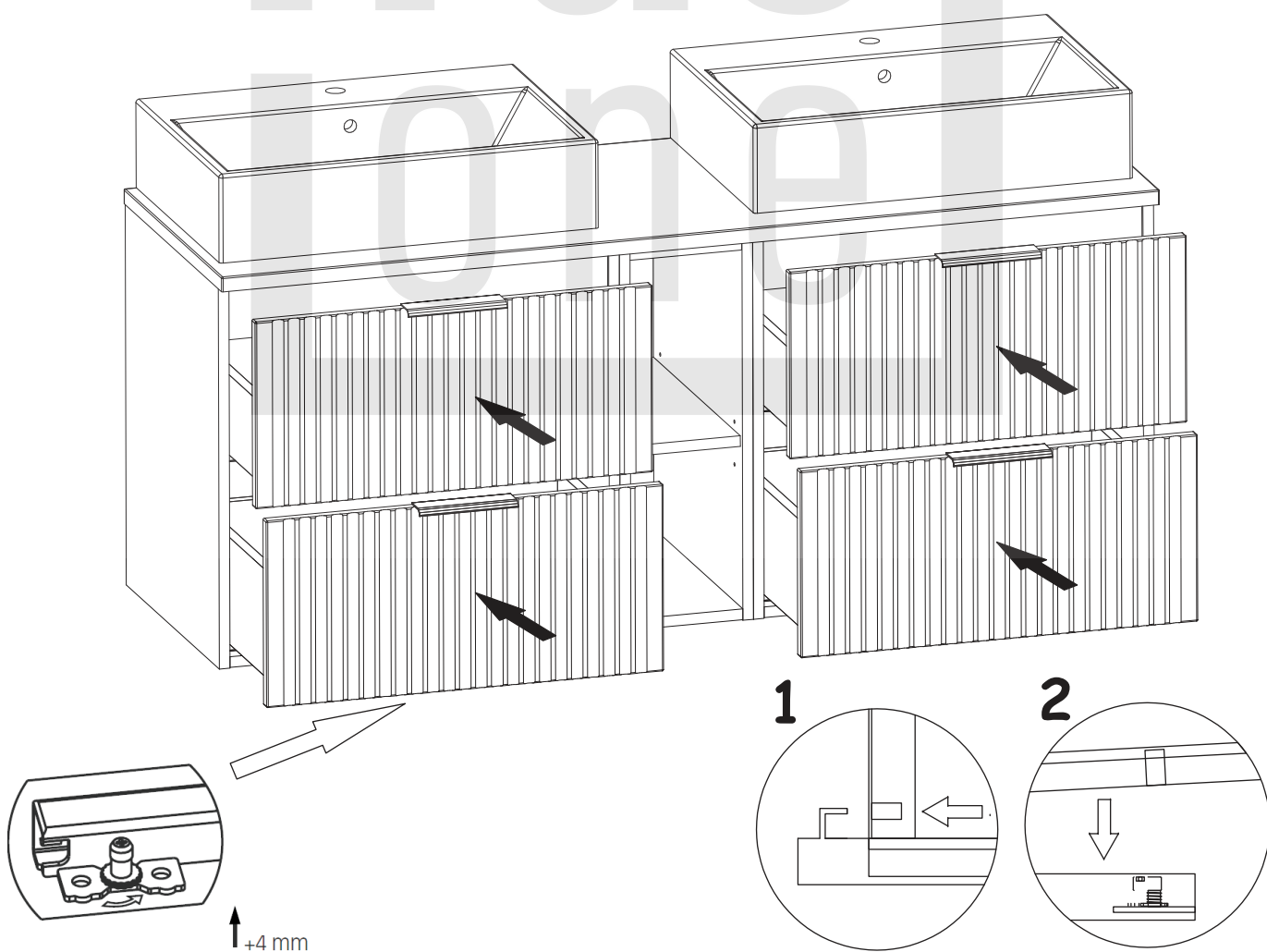

BLAT 140 CM BL854, 89-140-B
BLAT 160 CM BL855, 89-160-B
BLAT 180 CM BL856, 89-180-B

7

