

SŁUPEK WYSOKI 1D 80-01-B-1D

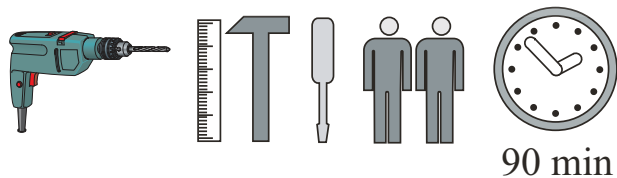

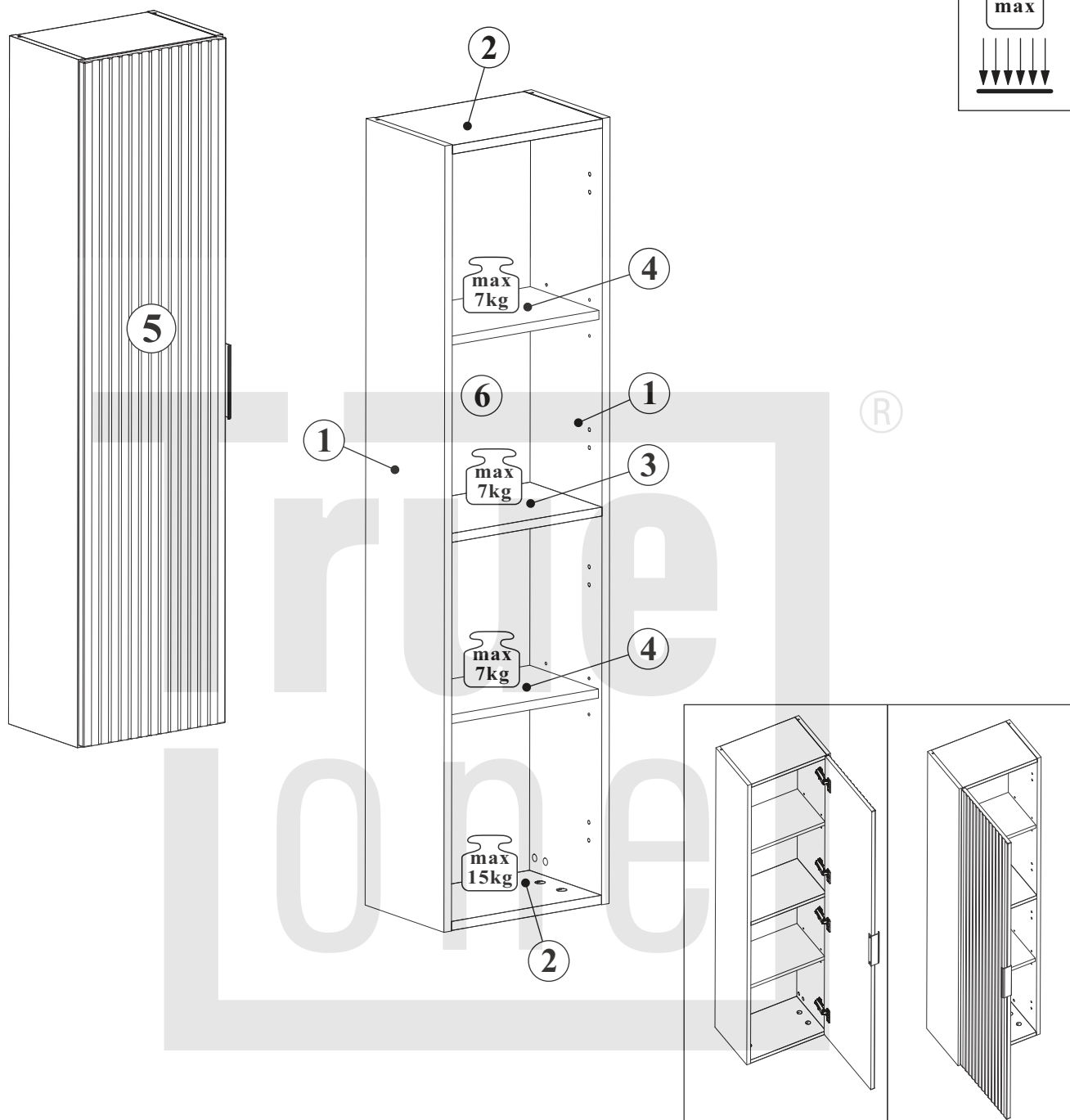

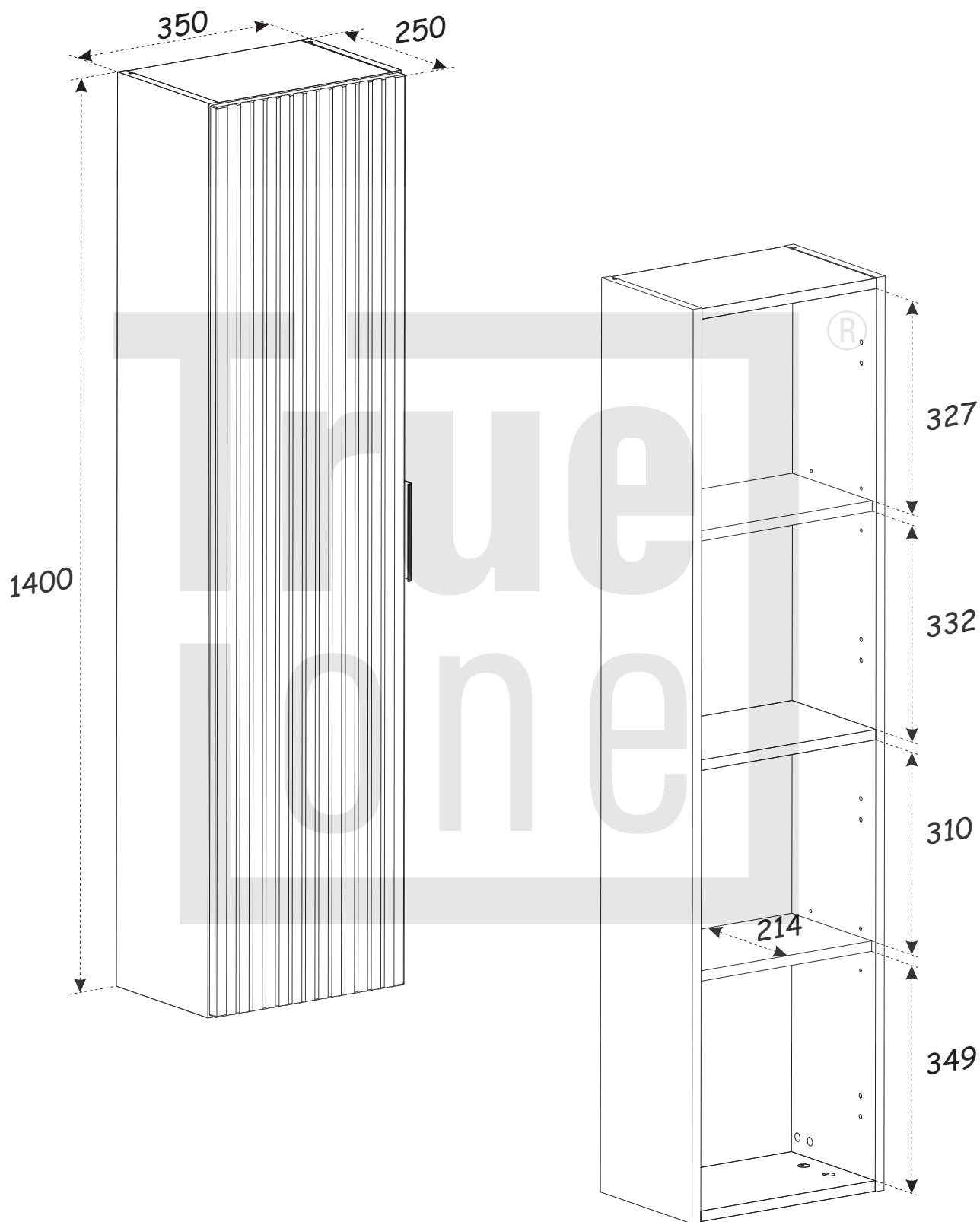



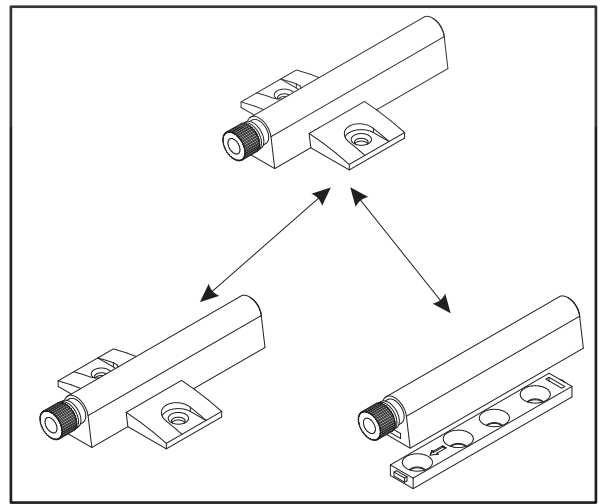
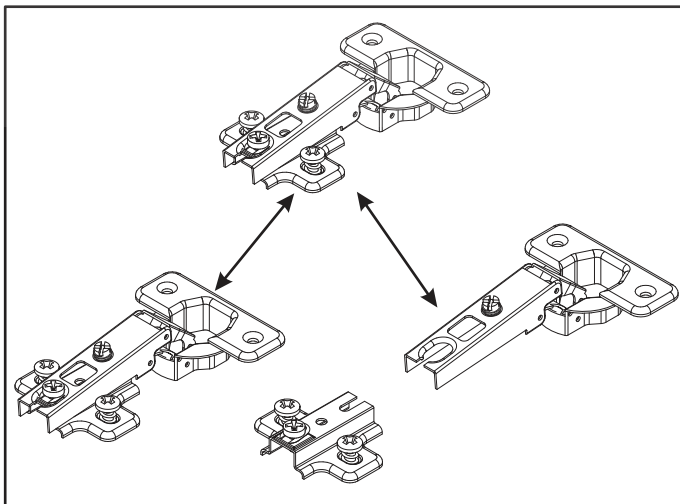
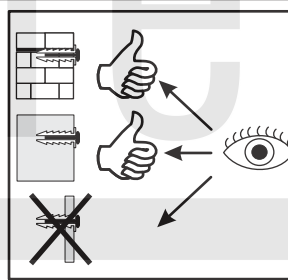
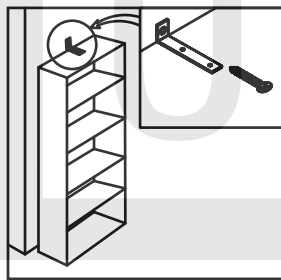
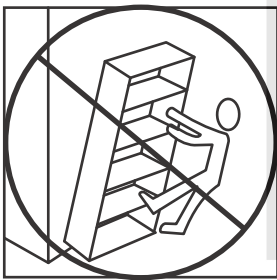
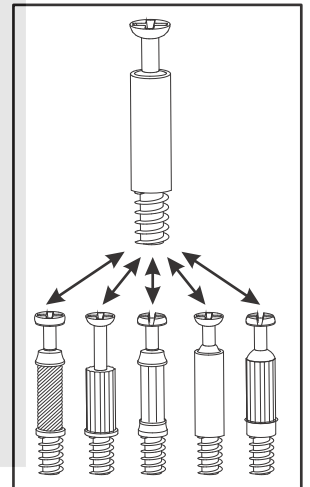
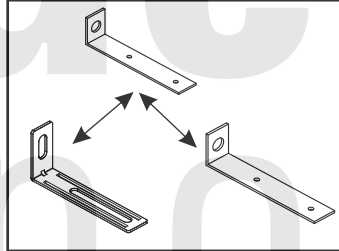
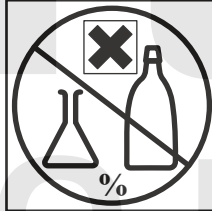
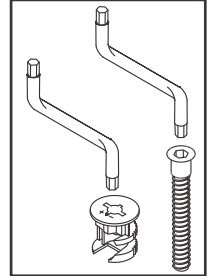
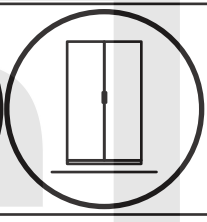
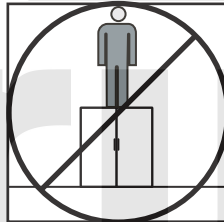
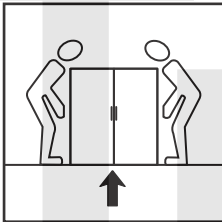
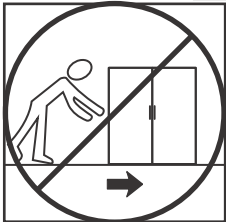
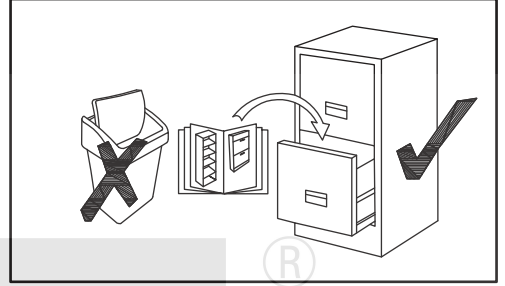
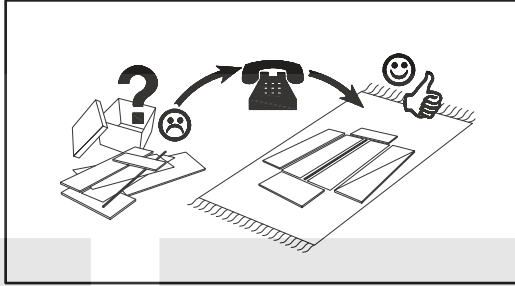
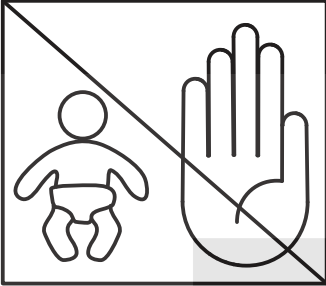
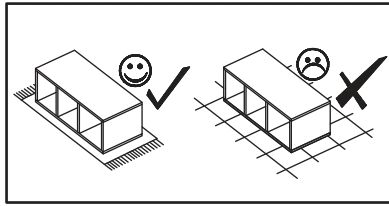
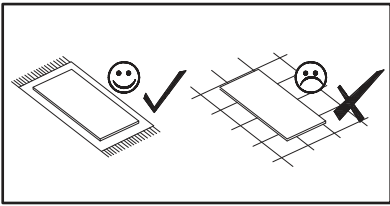



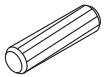
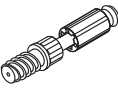

NO	Dim.			Col.-No	Qty
1	1400	234	16	1	2
2	318	234	16	1	2
3	318	214	16	1	1
4	318	204	16	1	2
5	1394	344	16	1	1
6	1378	330	3	1	1

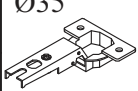
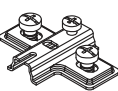
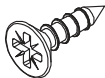
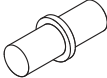
SŁUPEK WYSOKI 1D 80-01-B-1D

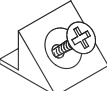

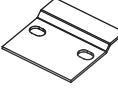
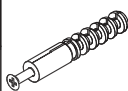
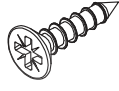

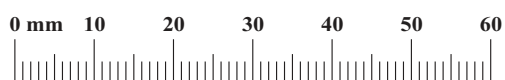

SŁUPEK WYSOKI 1D 80-01-B-1D

A1 x12  ø8x36	B4 x12 	B5 x12  ø15x12	G5 x12 	ZXP x1 	ZXL x1 
E21 x4 Ø35  H=0	E2 x4  H=0	D10 x8  USØ3,5x13	G7 x8 	Z2 x8  Ø5	Z5 x4  Ø10
S1 x8 	G04 x1  L-148mm.	SZ7 x2 	KR1 x4 	D7 x2  USØ3x16	D6 x4  USØ3,5x30
UP13 x3  UPØ3x16	G2 x1 				



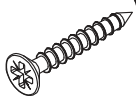

1

D6	
x4	USØ3,5x30

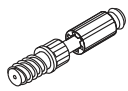
Z5	
x4	Ø10

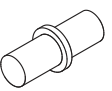
B4	
x12	

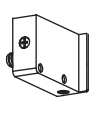

G7	
x8	

ZXP	
x1	

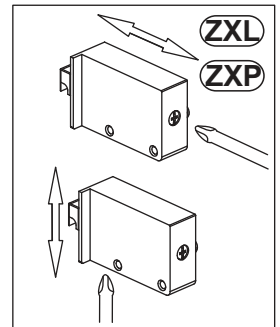
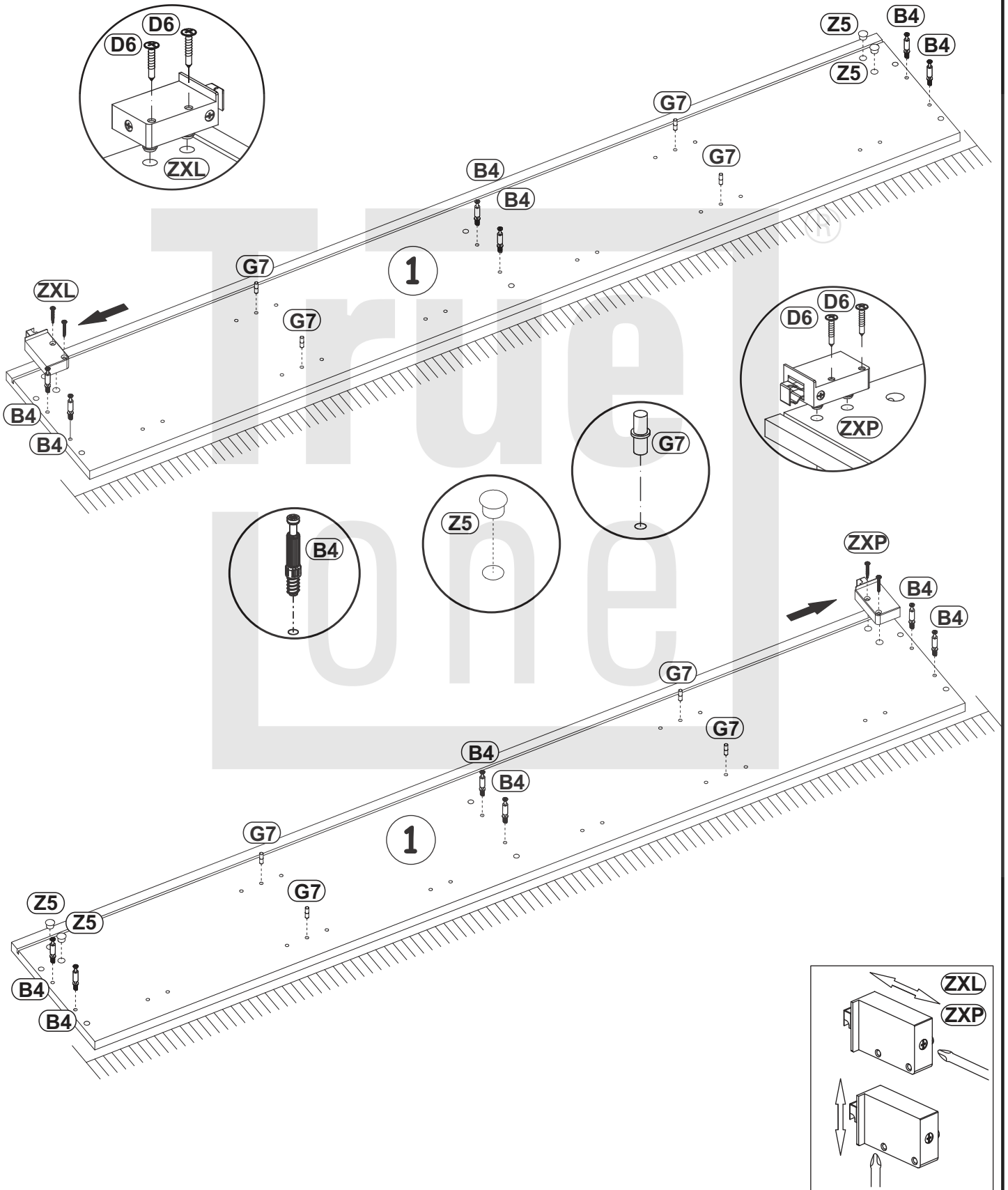
ZXL	
x1	



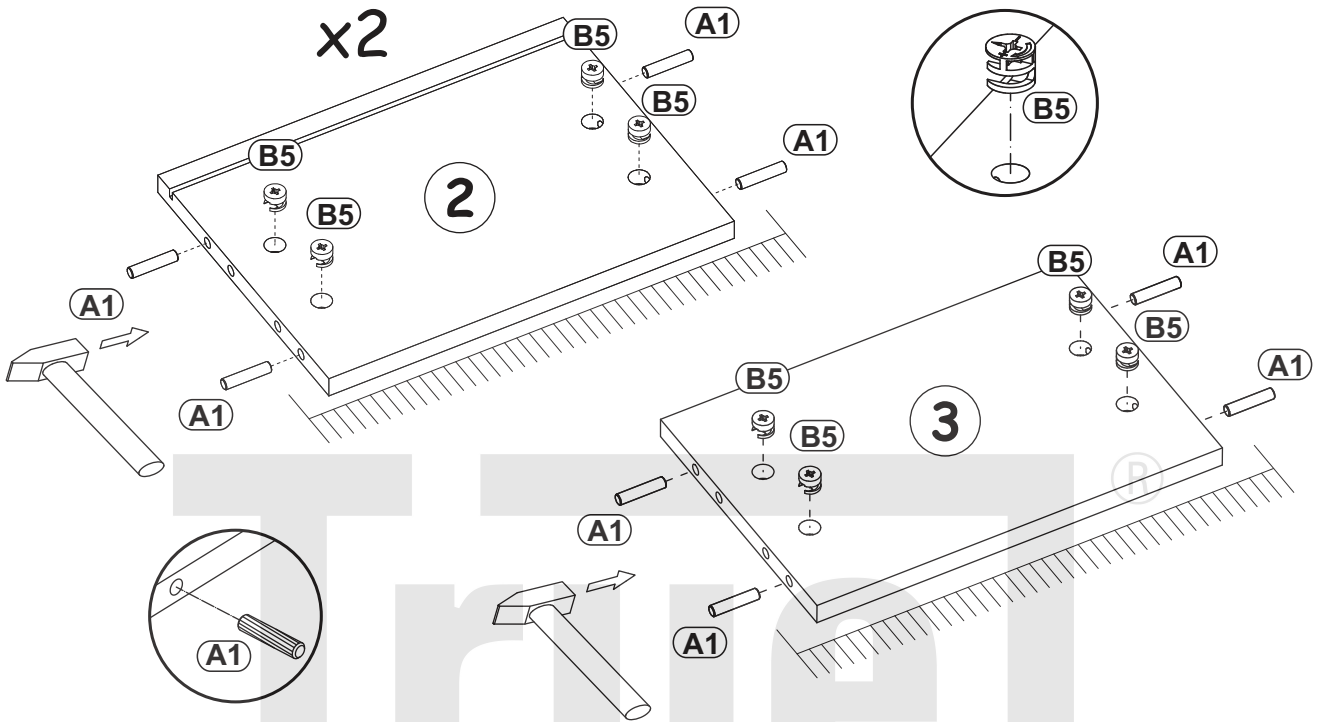

2

A1		B5	
x12	ø8x36	x12	ø15x12



3

D10		E21	
x8	USØ3,5x13	x4	Ø35 H=0

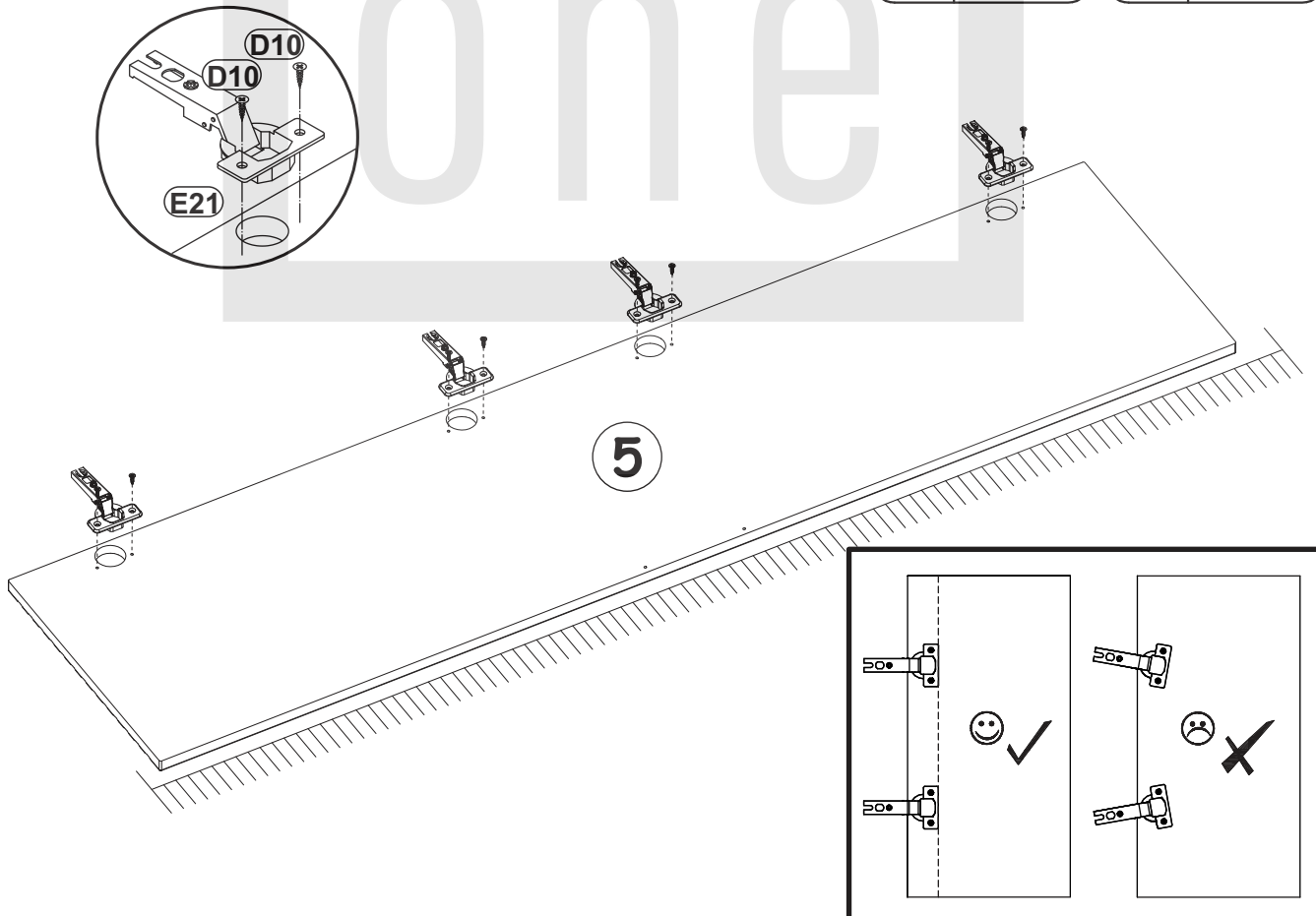

G5	
x6	

4

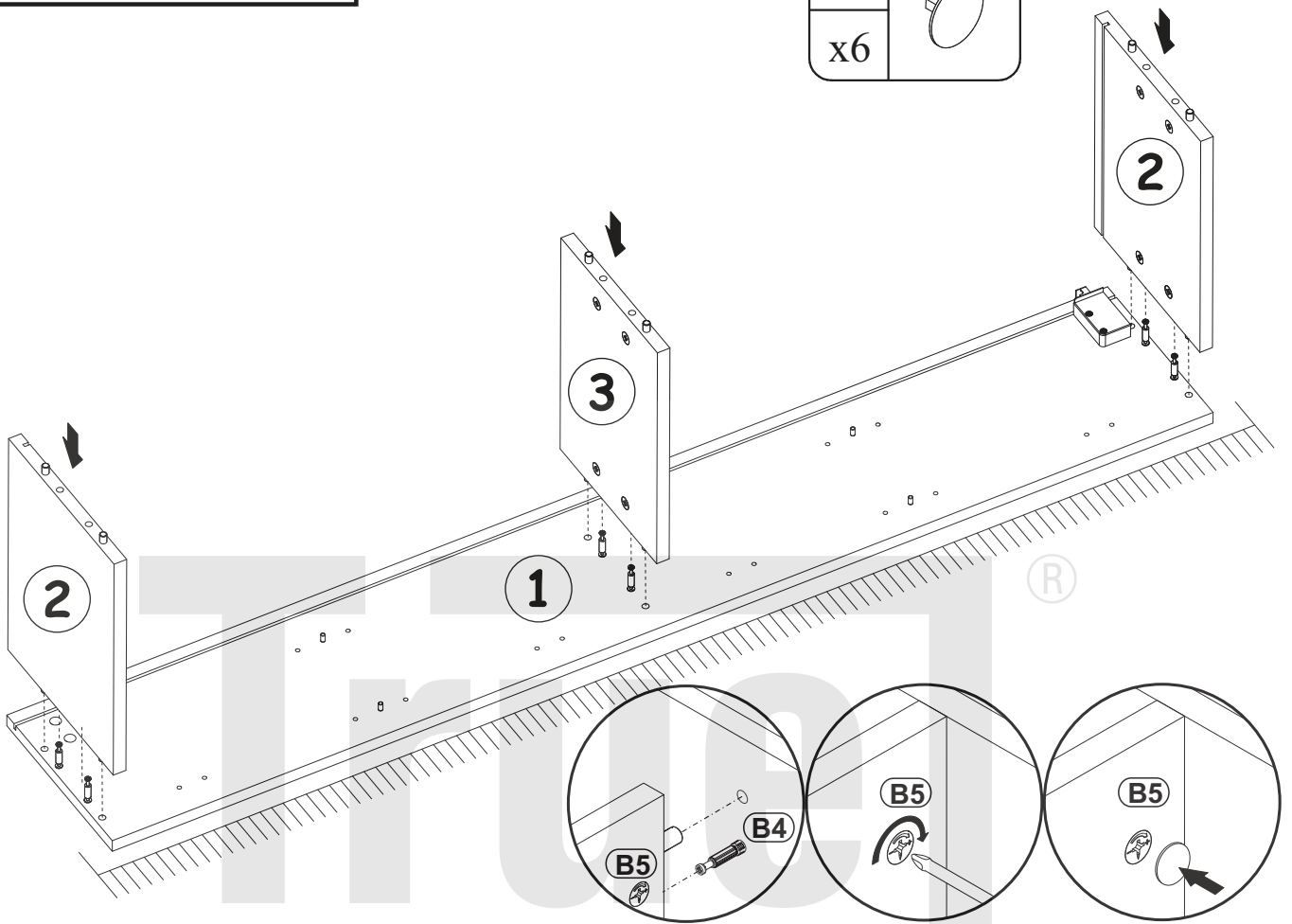

5

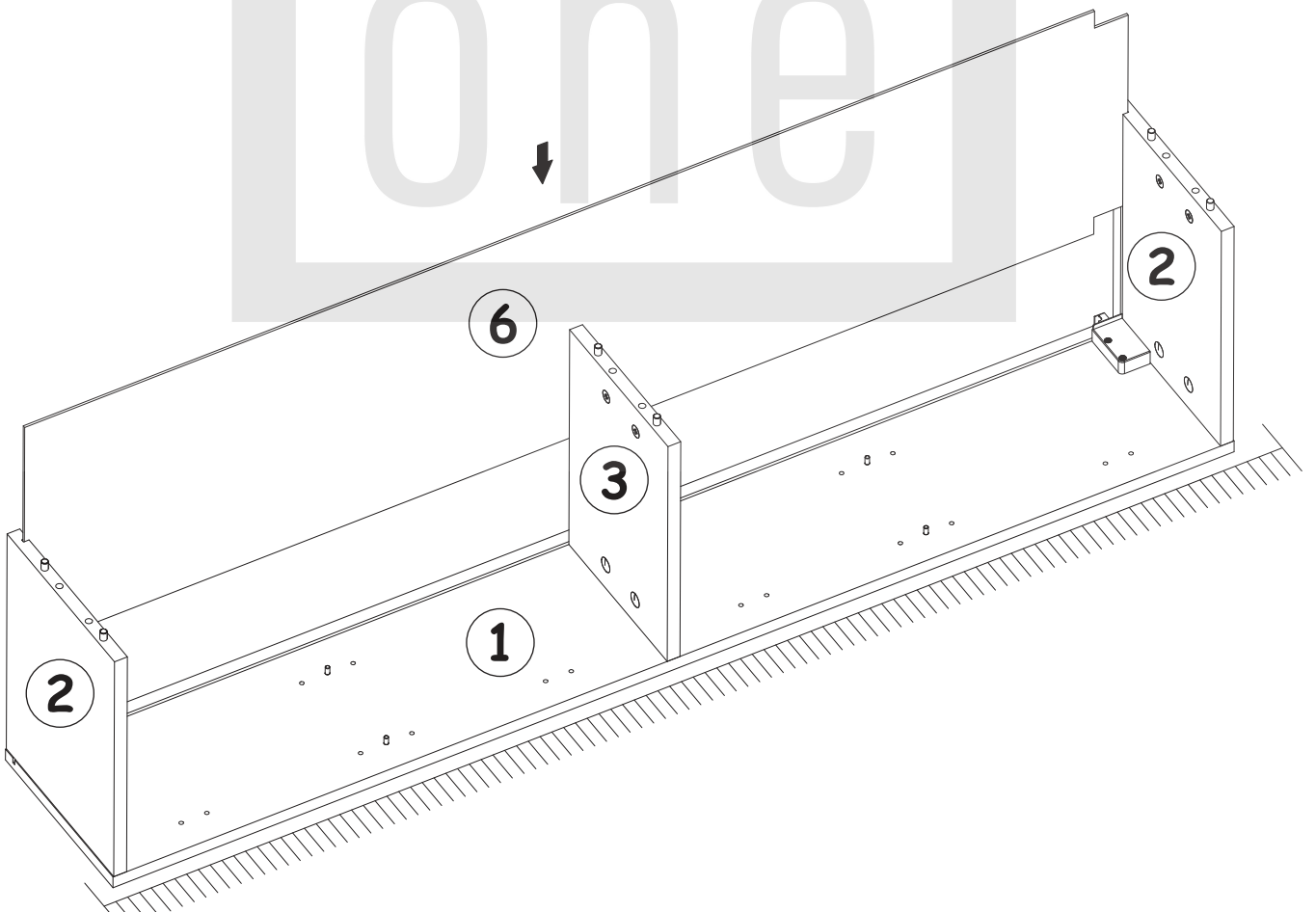

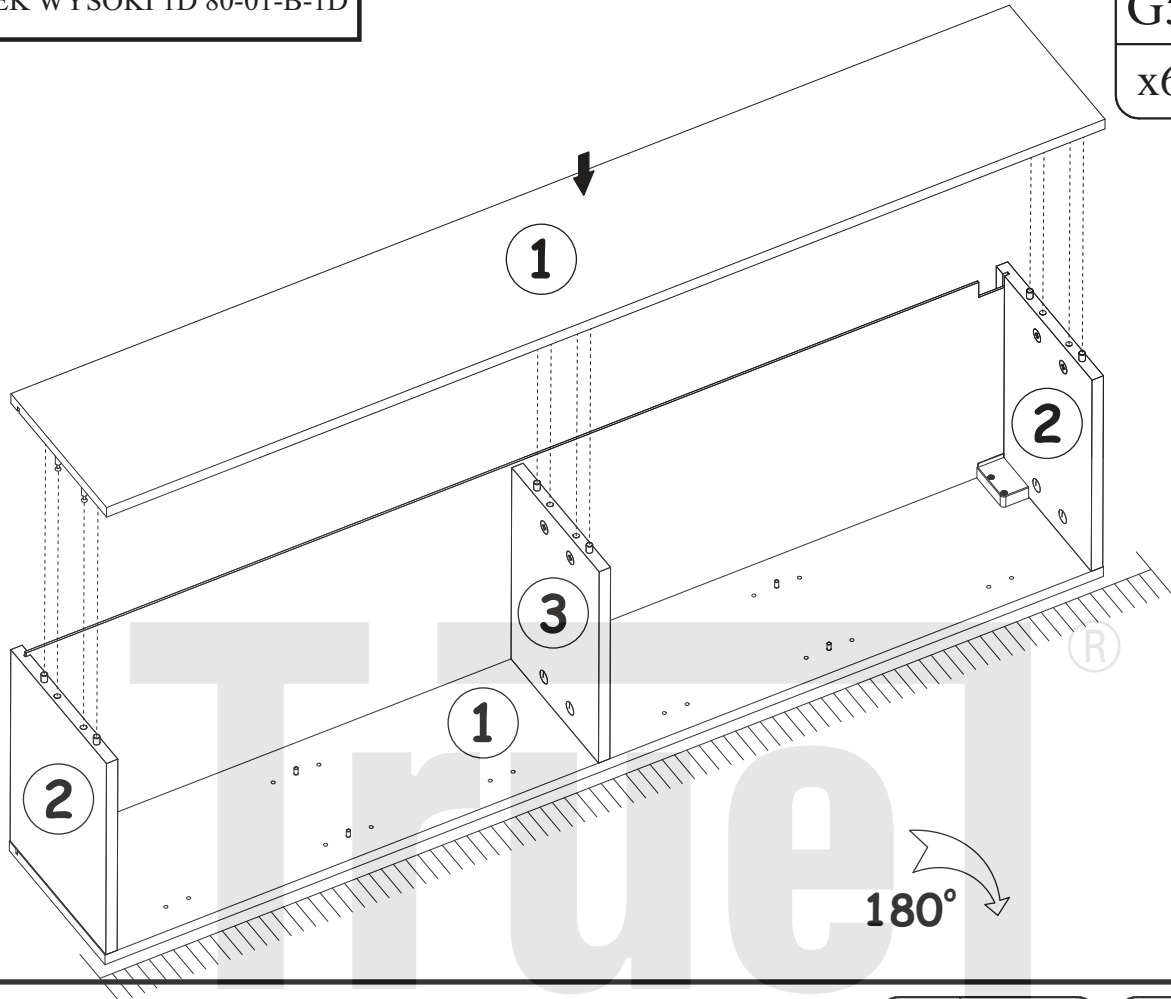

6

G5	
x6	

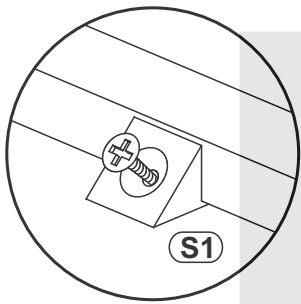

7

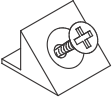

UP13		S1	
x3	UP03x16	x8	

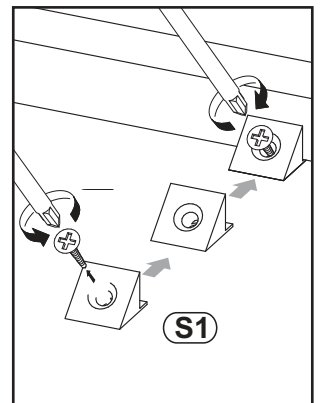
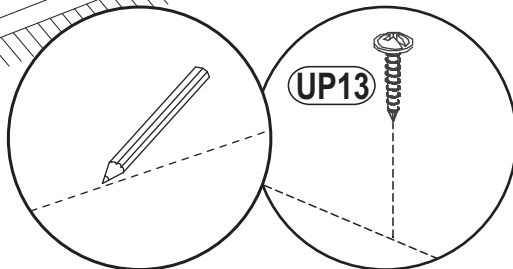
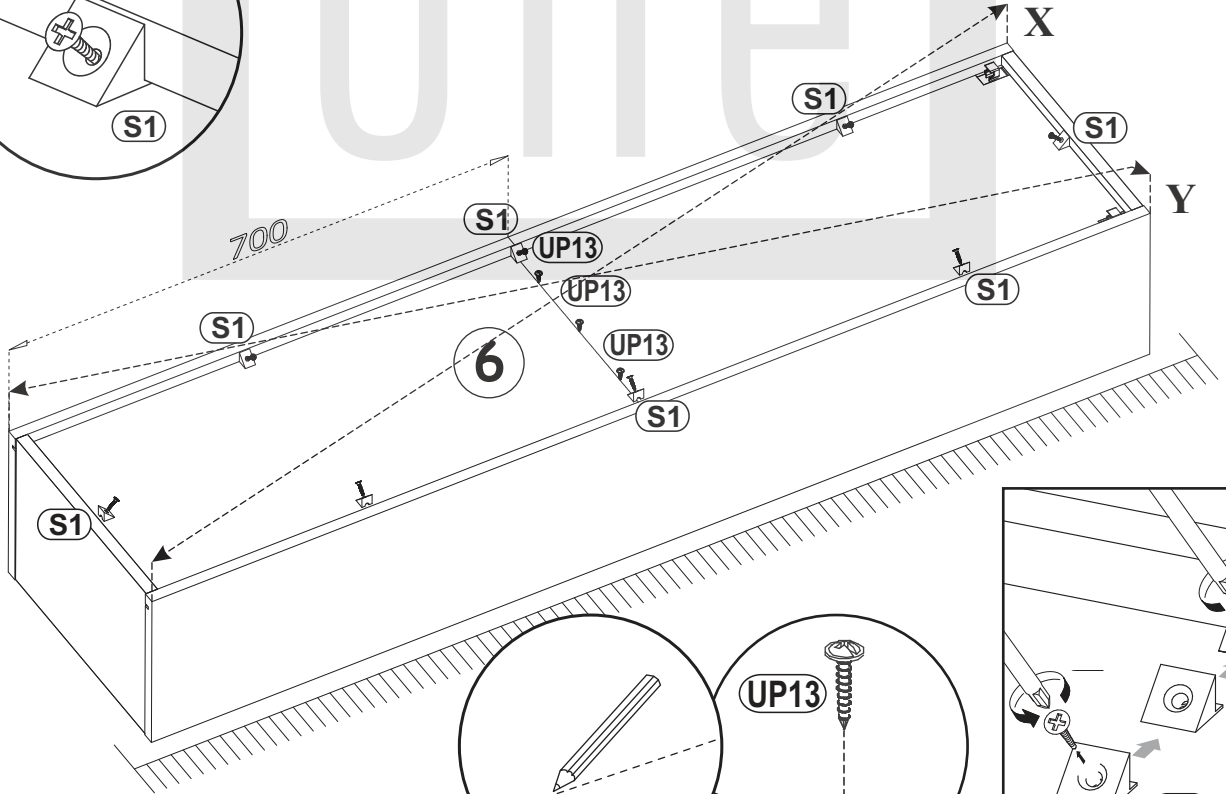

8

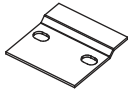
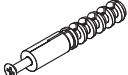
SZ7		KR1	
x2		x4	

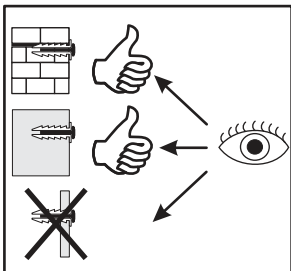
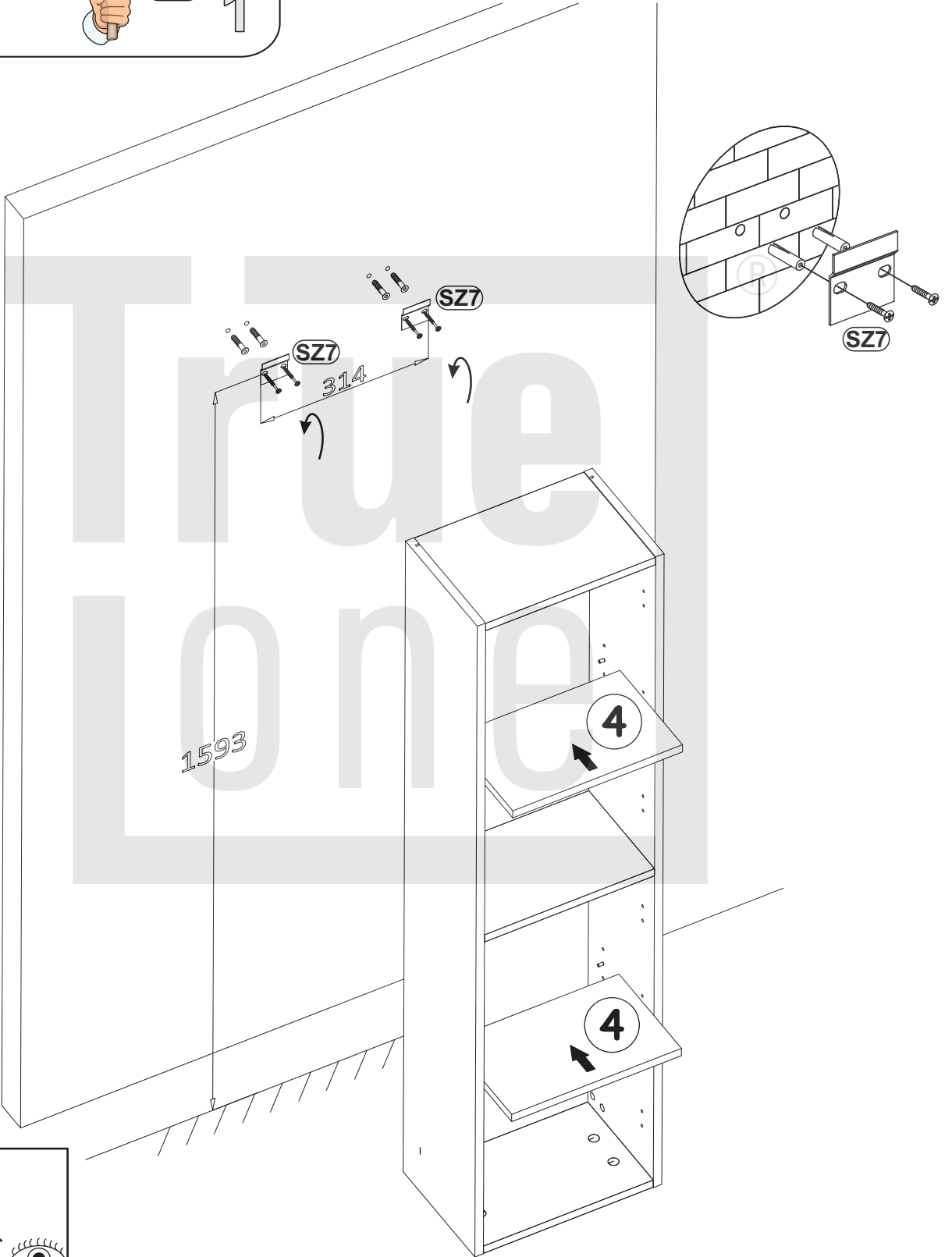
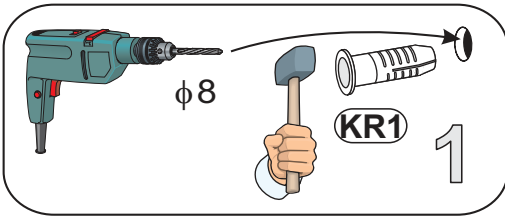

9-11

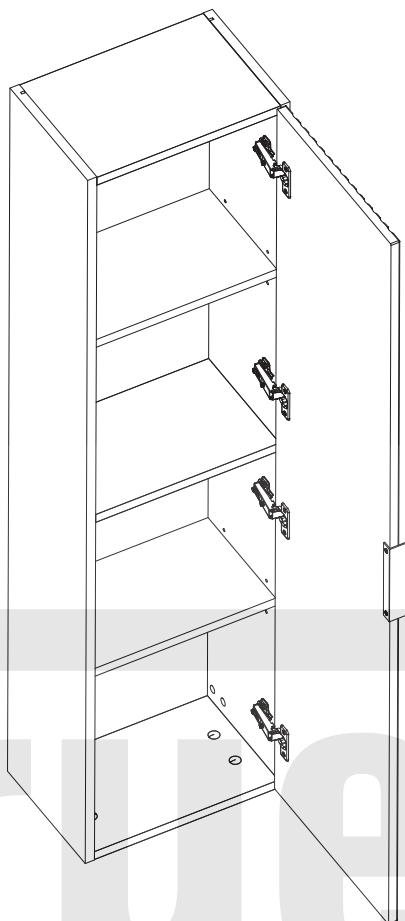

12-14

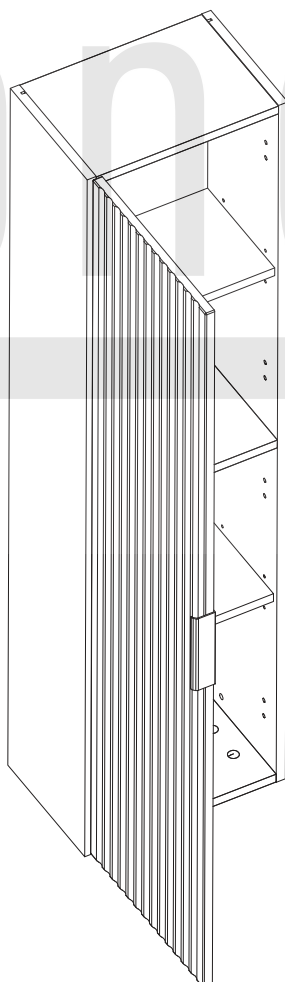

9

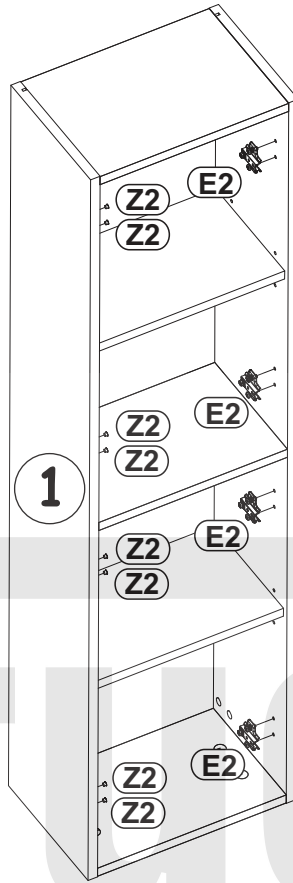
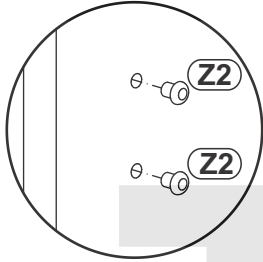
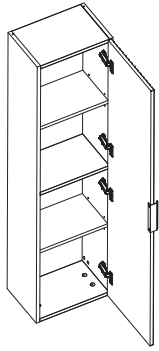

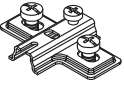
Z2		E2	
x8	Ø5	x4	H=0

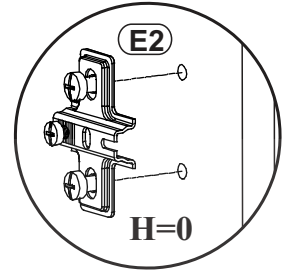

10

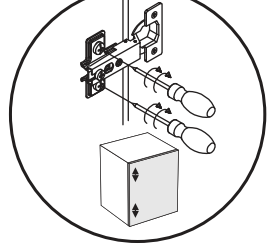
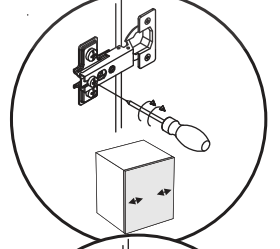
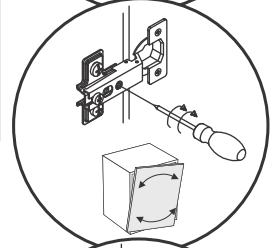
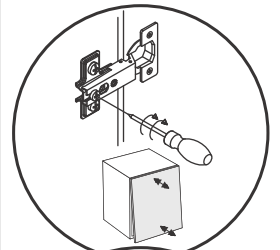
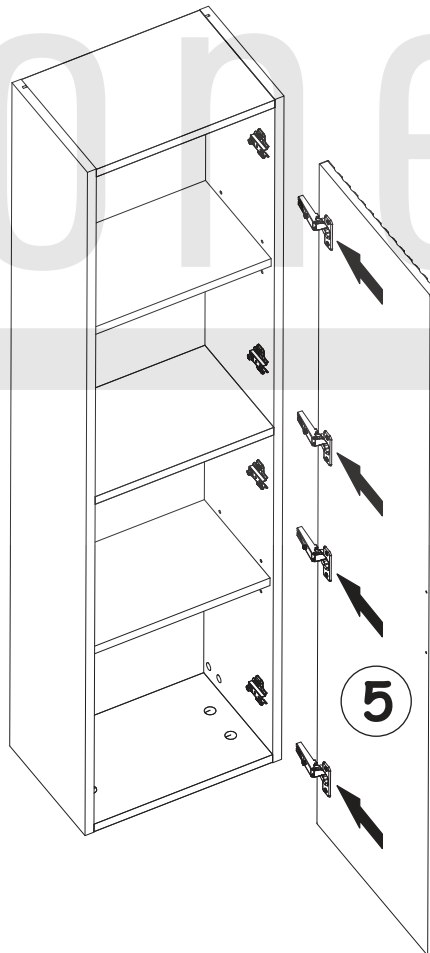
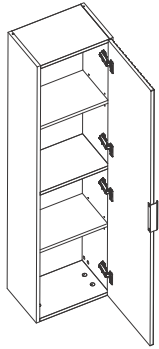

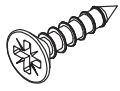
D7	
x2	USØ3x16

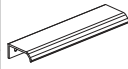
G04	
x1	L-148mm.

11

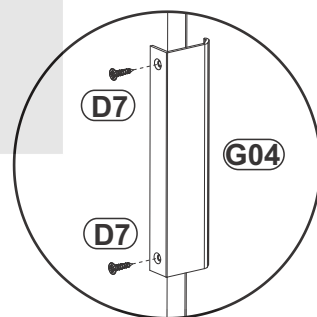
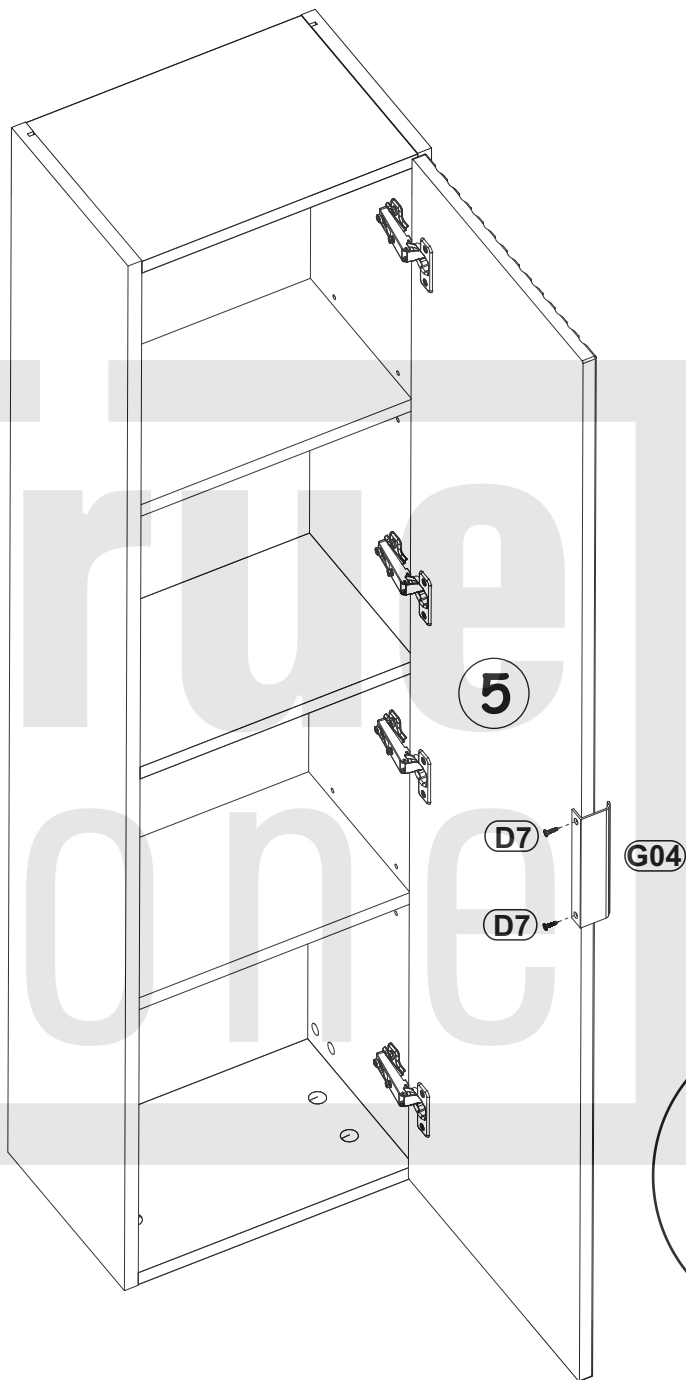
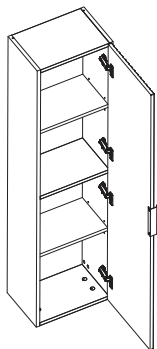

12

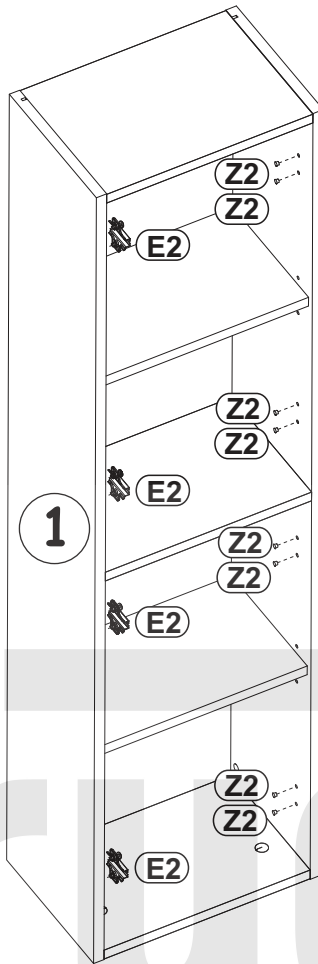
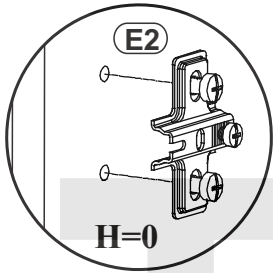
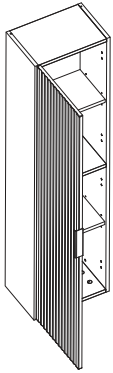

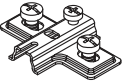

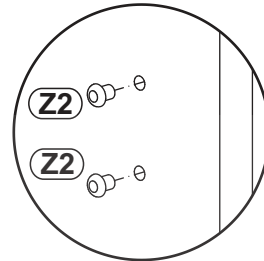
Z2		E2	
x8	Ø5	x4	H=0

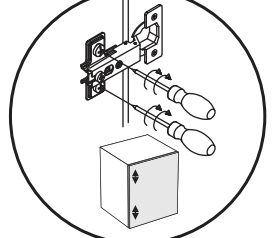
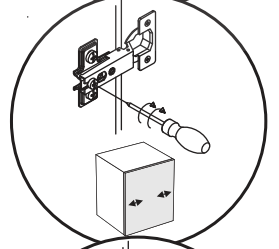
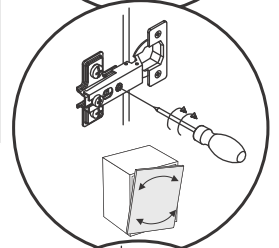
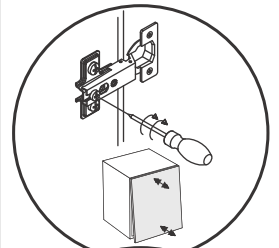
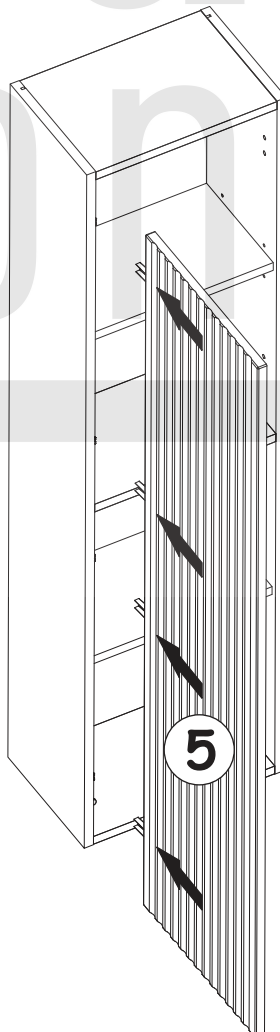
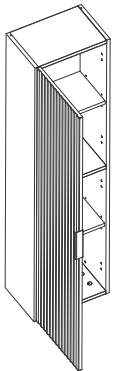

13

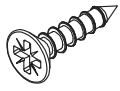

D7		G04	
x2	USØ3x16	x1	L-148mm.

14

