

# KORA

# 16

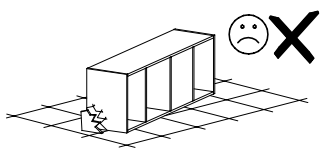

Narzędzia potrzebne do montażu

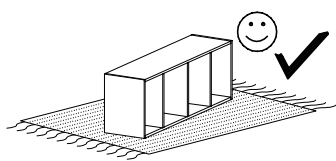
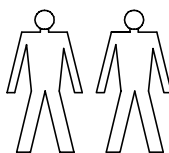
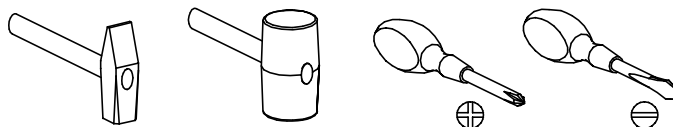

### UWAGA !!

MONTOWANIE USZKODZONYCH  
ELEMENTÓW POWODUJE UTRATĘ  
GWARANCJI

nr	D[mm]	S[mm]	G[mm]	Ilość
1	625	625	65	1
2	625	625	65	1
3	1835	268	16	1
4	1835	268	16	1
5	1835	195	16	1
6	578	578	16	3
7	578	578	16	1
8	1860	234	2,5	4
9	1005	443	16	1
9	772	443	16	1

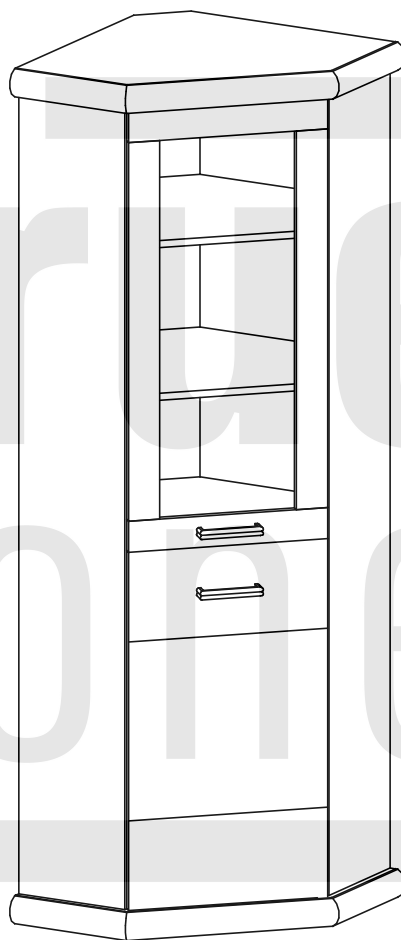

### UWAGA !!

Mebel zawiera  
elementy drewniane

W przypadku reklamacji proszę o podanie numeru pakowacza znajdującego się na kartonie



**A1 - 5 St.**  
7 x 50 mm



**A2 - 5 St.**  
6 x 50 mm

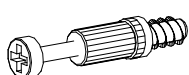

**K - 8 St.**



**L - 8 St.**

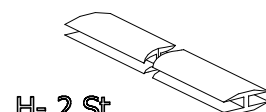

**H - 2 St.**



**S - 18 St.**



**F - 5 St.**



**U - 2 St.**

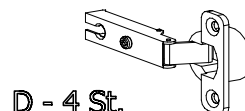

**D - 4 St.**

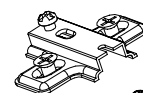

**C - 4 St.**



**E - 80 St.**

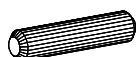

**B - 12 St.**



**G - 8 St.**  
3,5 x 16 mm

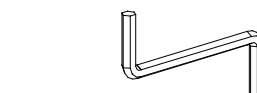

**Z - 1 St.**



**N - 4 St.**  
4 x 30 mm

I

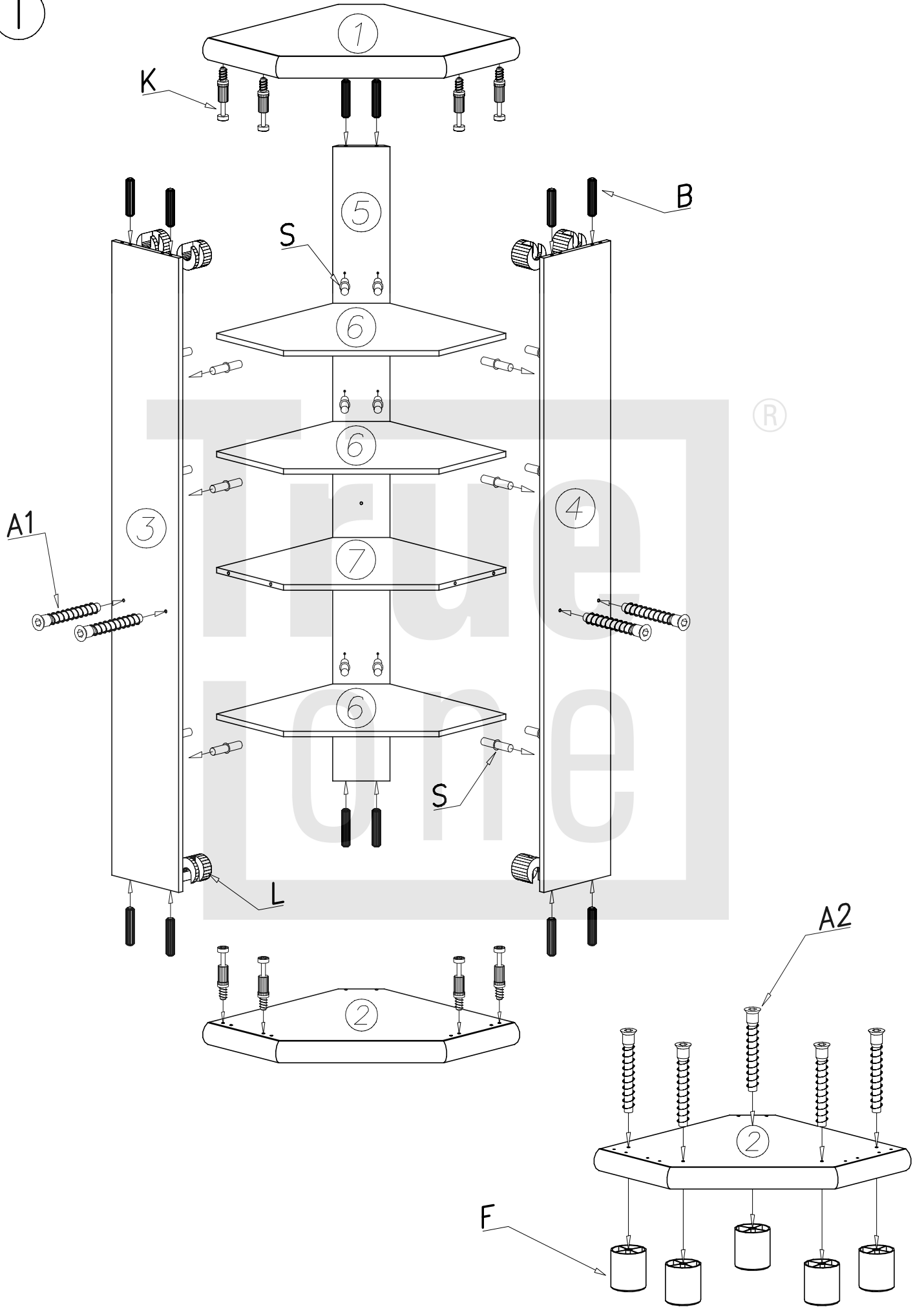

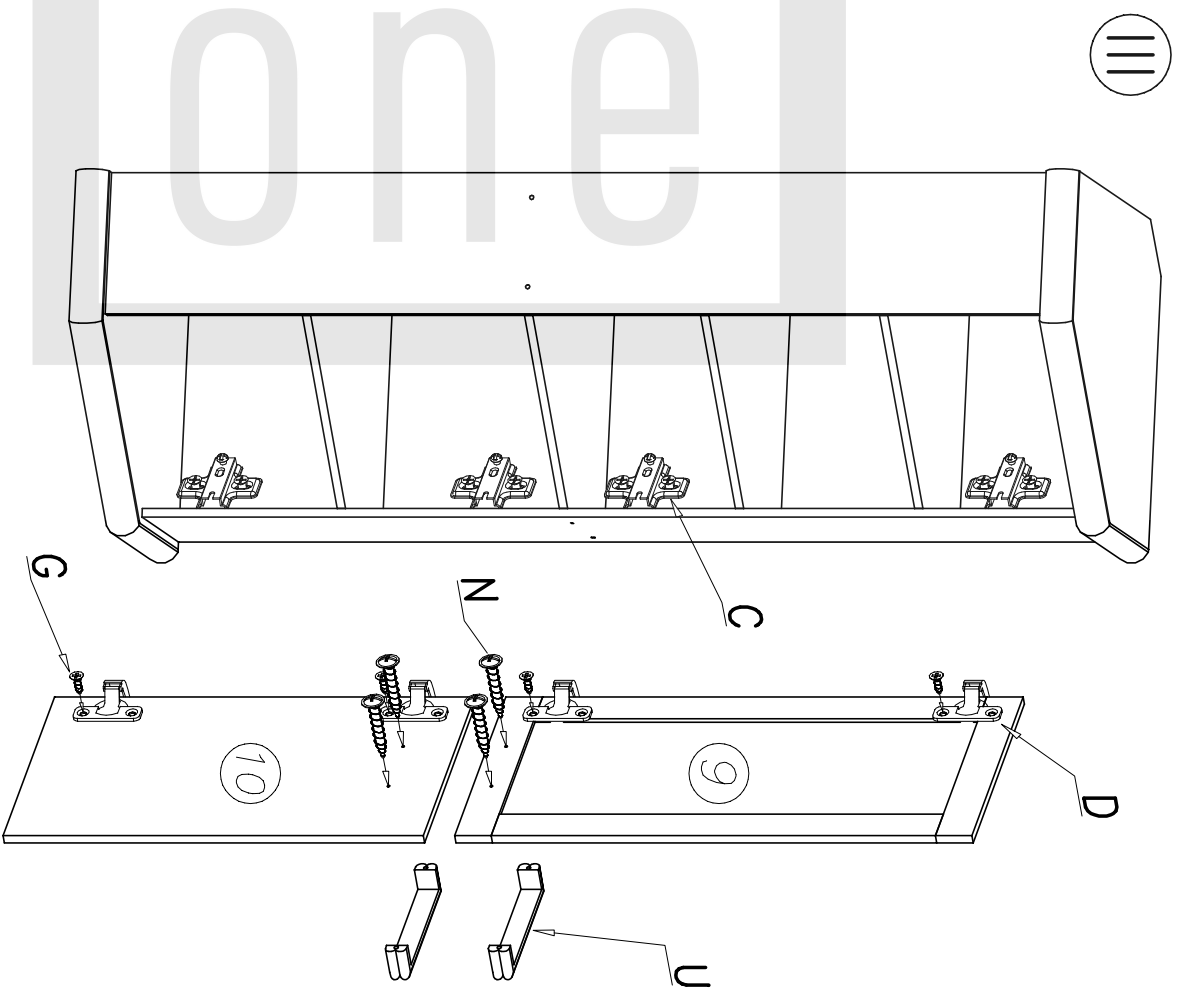
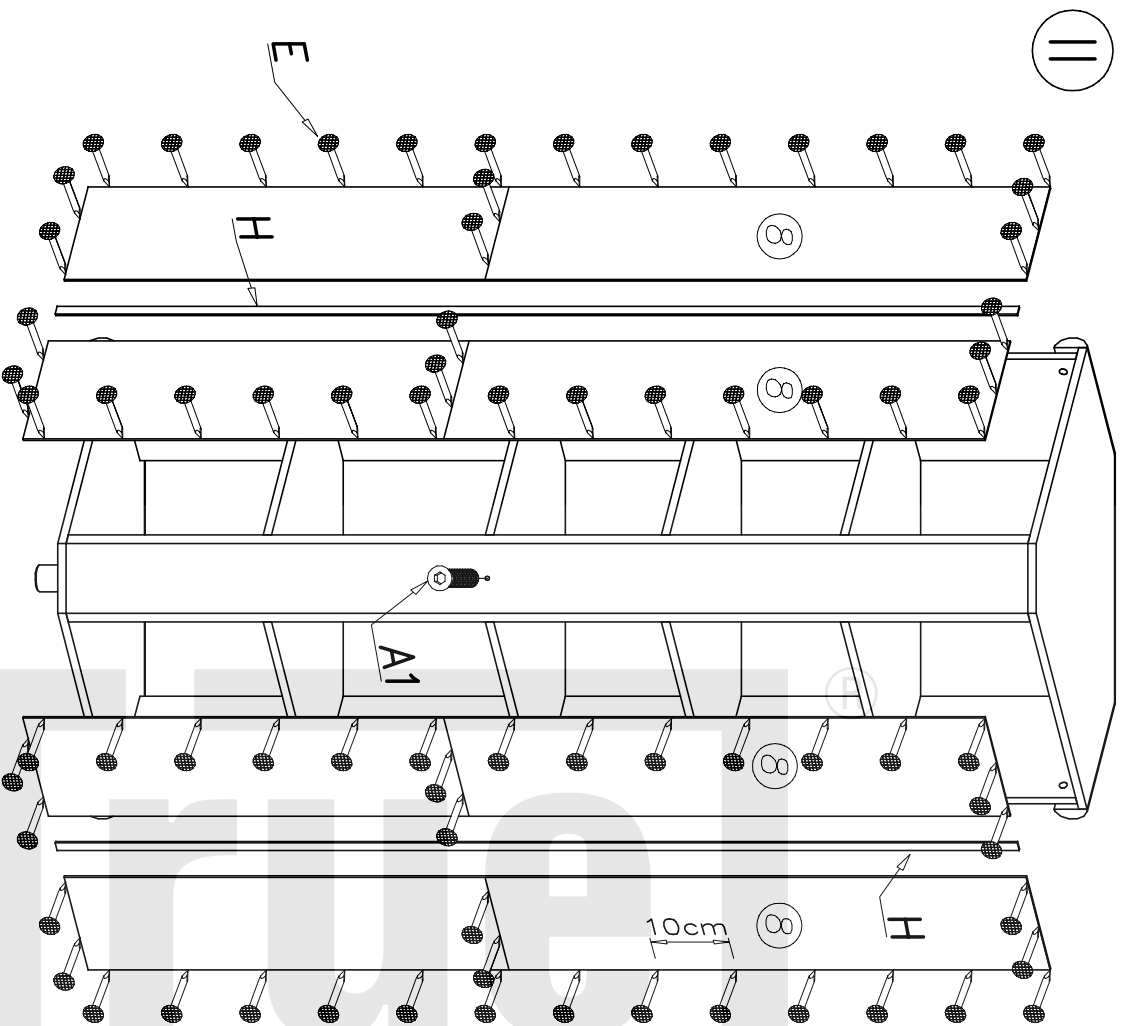

Meble zawierają elementy drewniane, których barwa i układ słojów są uzależnione od wielu czynników, dlatego mogą występować różnice w fakturze i barwie co nie stanowi wady produktu i nie wpływa na jego trwałość i funkcjonalność.

Listwy drewniane mogą ujawniać niewielkie zmiany w kształcie i wymiarach wywołane specyficznymi warunkami eksploatacji – wilgotność, różnice temperatur etc.