

B

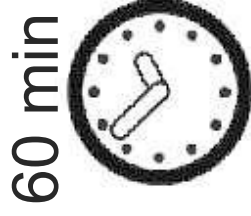

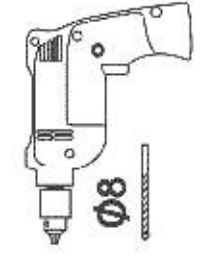

True®

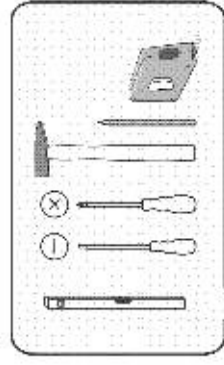
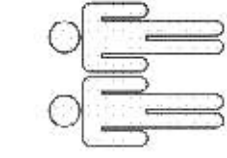
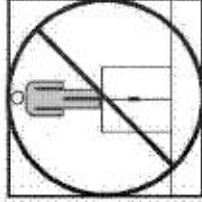
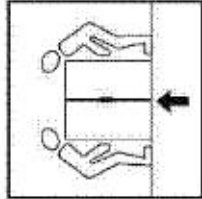
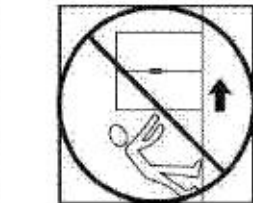
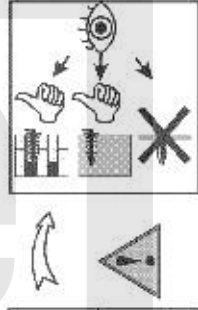
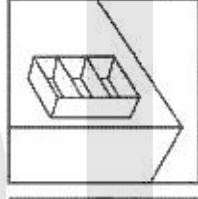
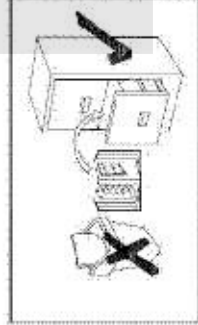
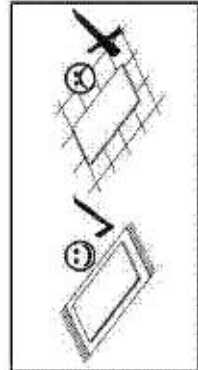
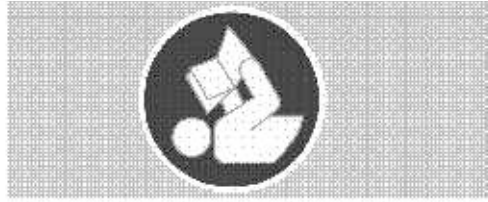
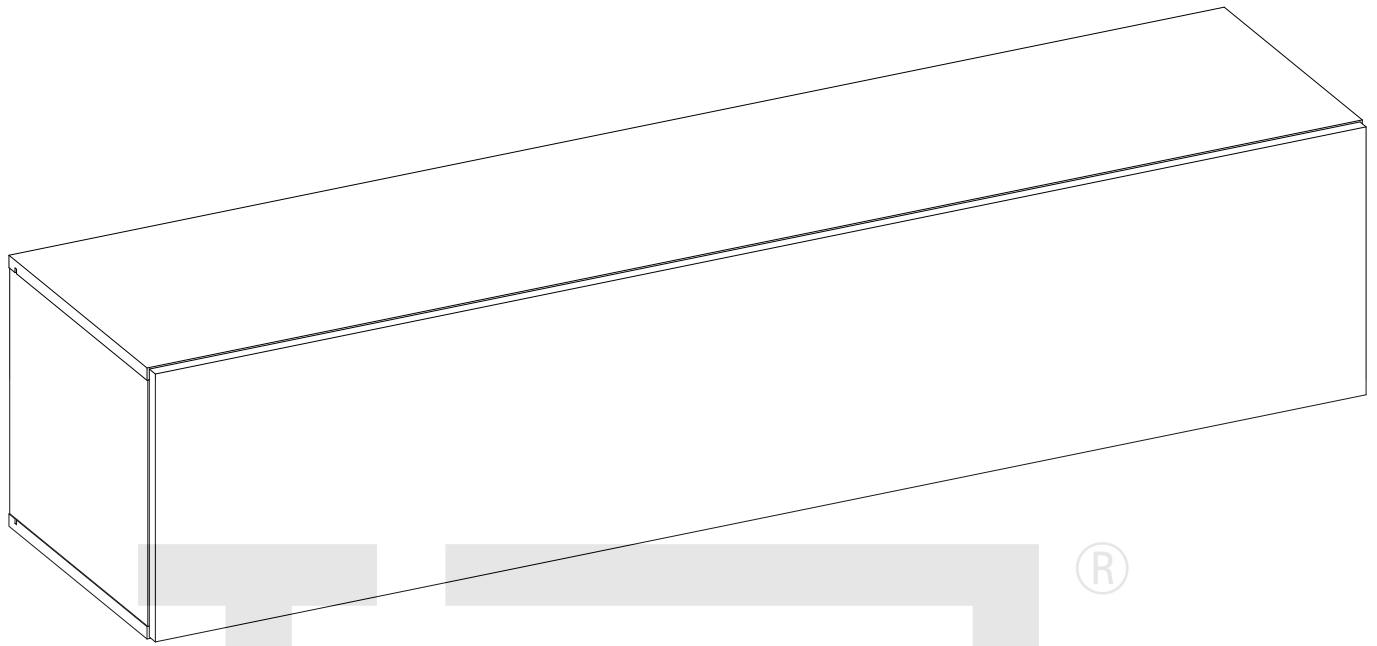
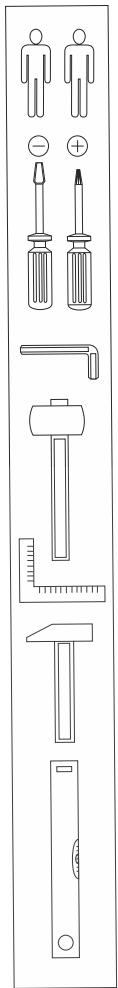
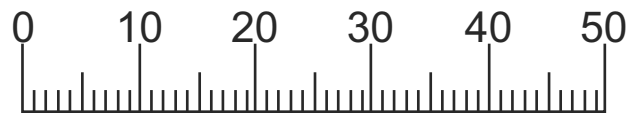
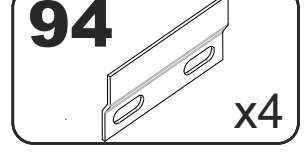
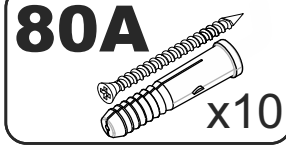
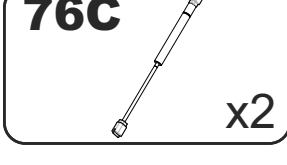
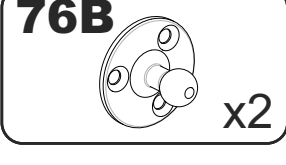
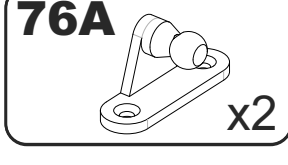
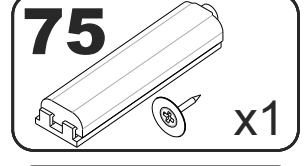
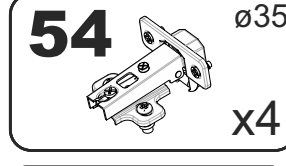
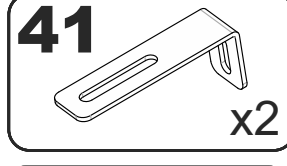
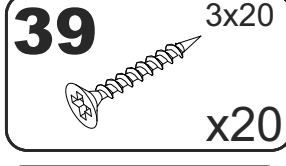
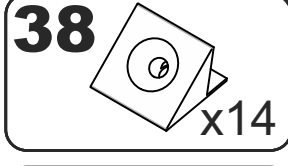
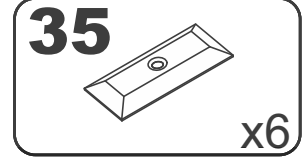
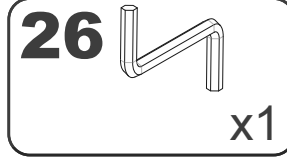
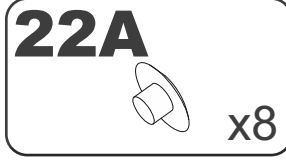
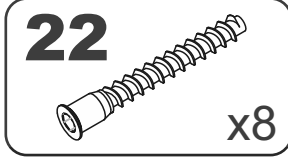
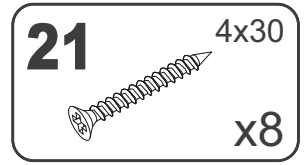
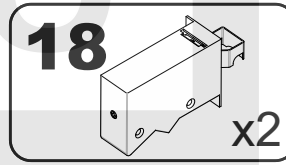
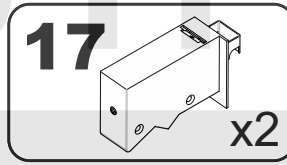
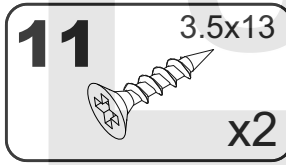
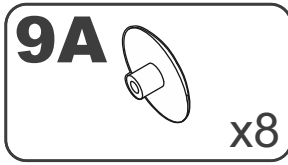
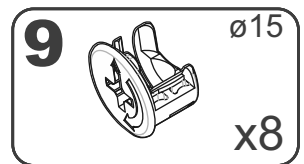
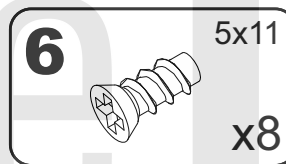
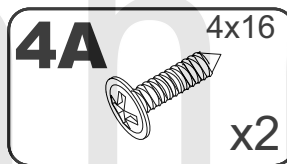
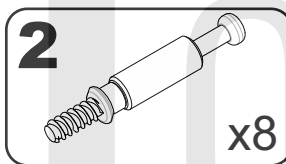
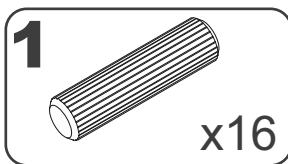

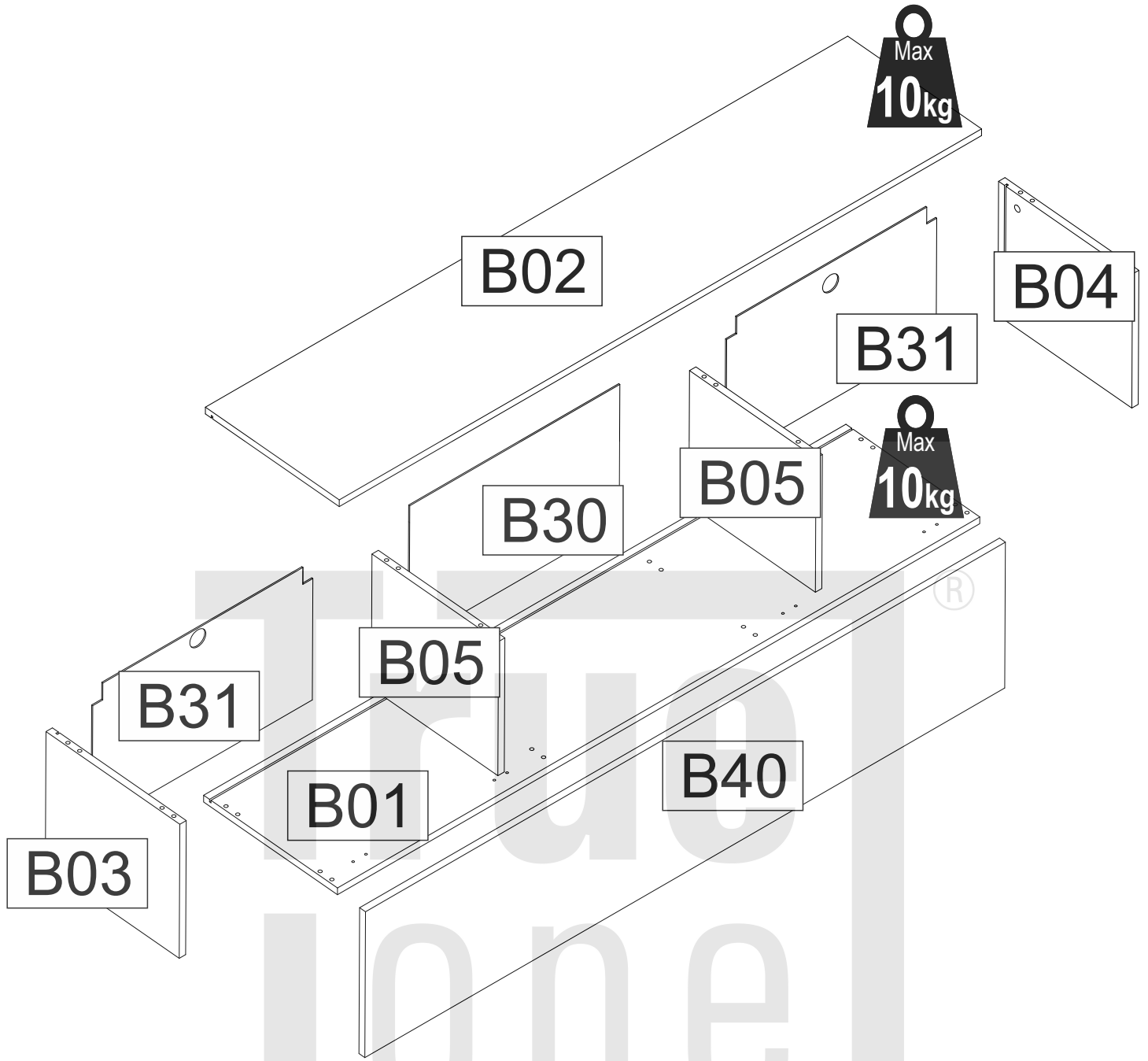

A	B_(mm)	C_(mm)	D_(mm)	E	F
B01	1502	364	16	1	1 1
B02	1502	364	16	1	1 1
B03	318	364	16	1	1 1
B04	318	364	16	1	1 1
B05	318	344	16	2	1 1
B30	491	328	3	1	1 1
B31	491	328	3	2	1 1
B40	1500	348	16	1	1 1

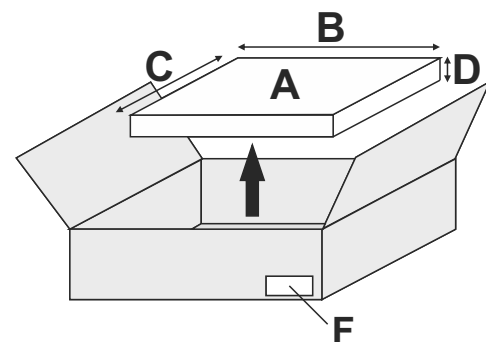
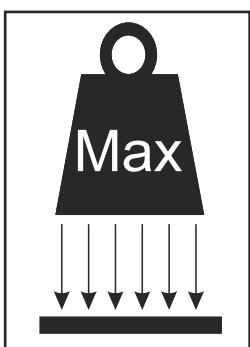

1

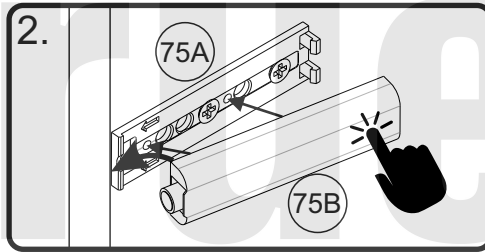
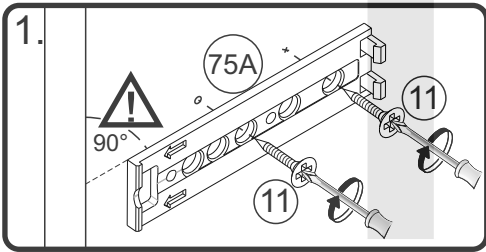
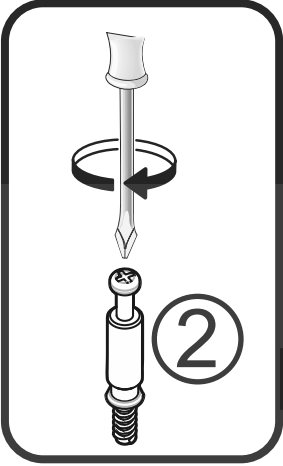
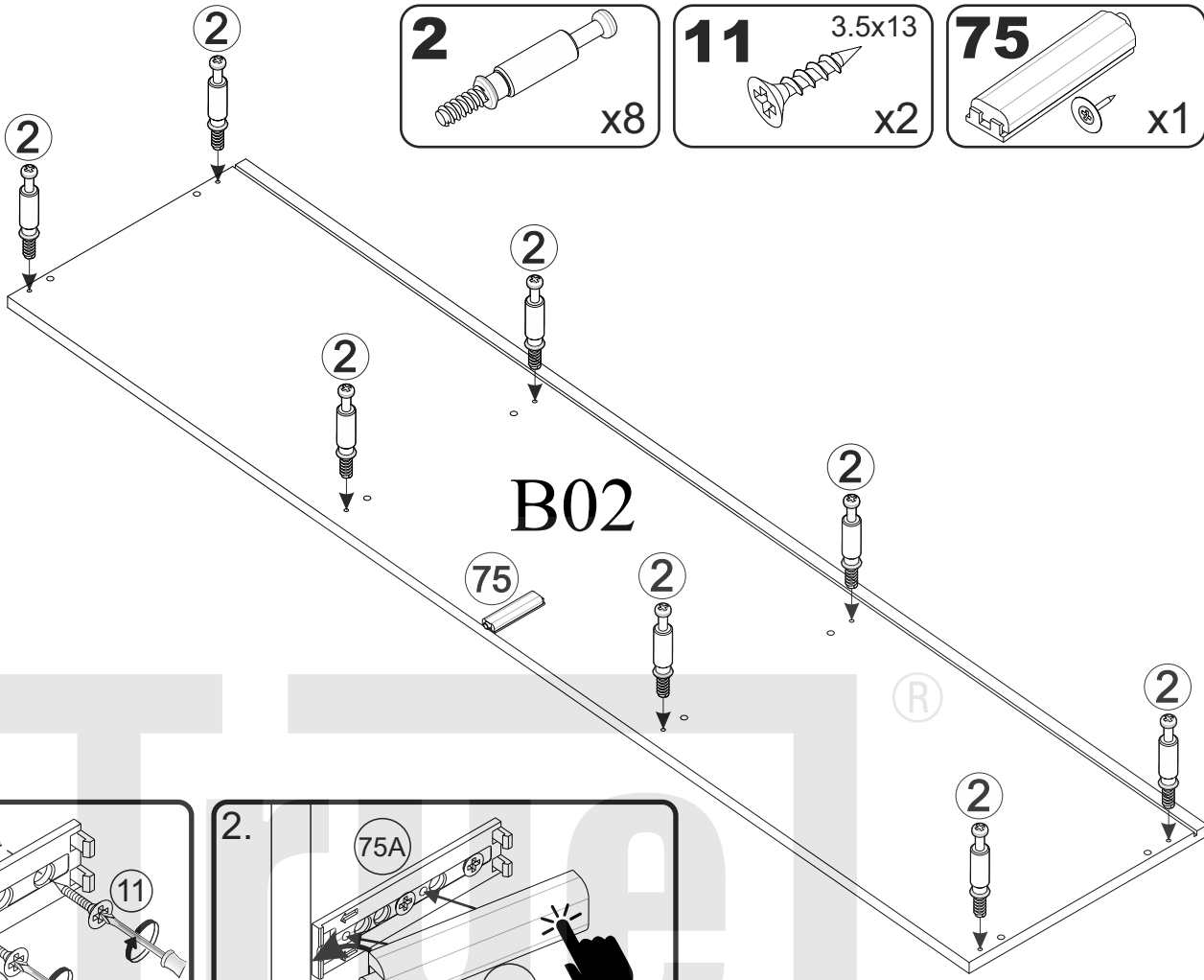
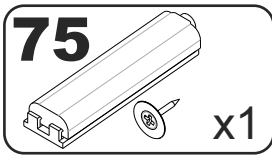
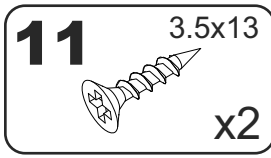
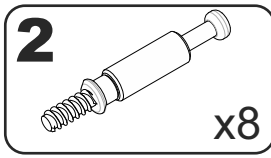

2

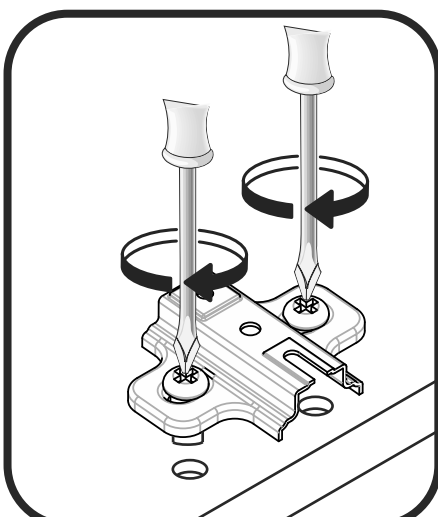
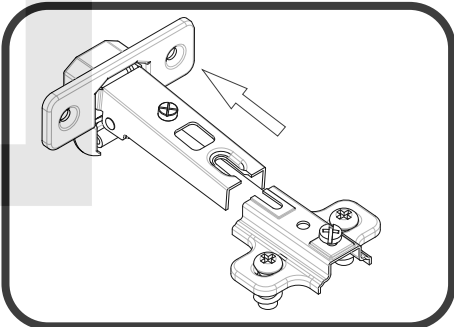
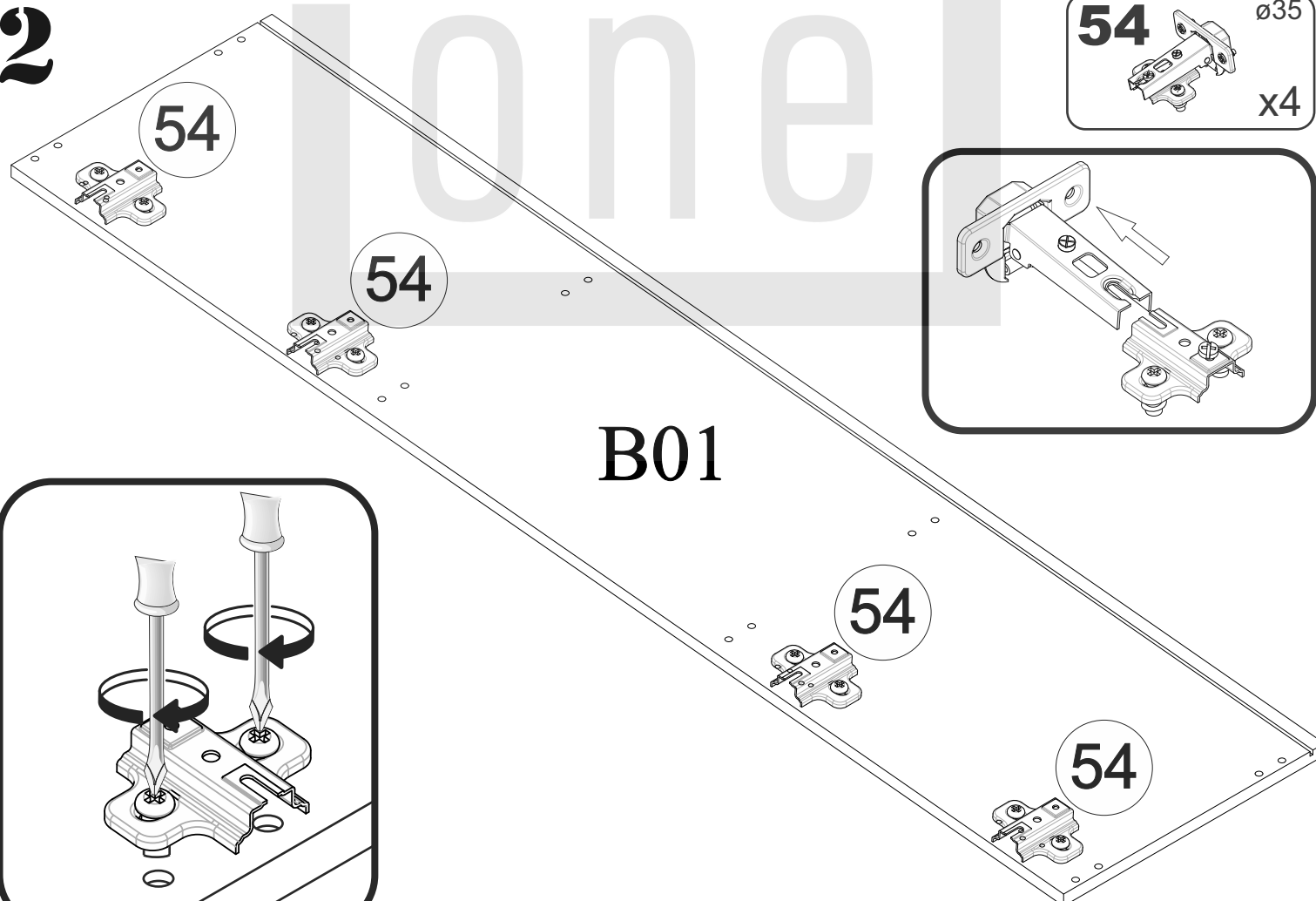
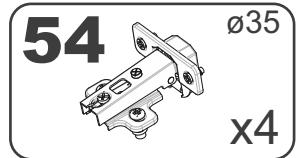

5

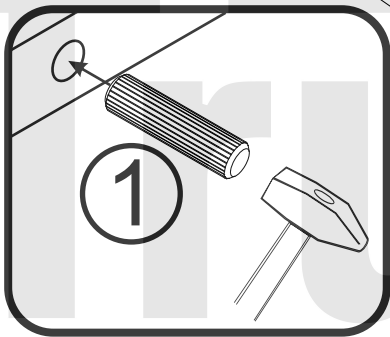
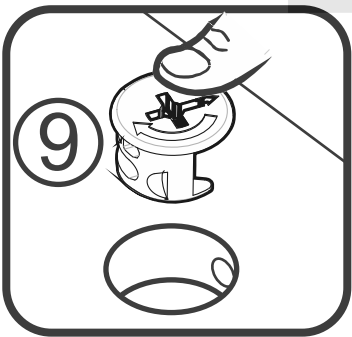
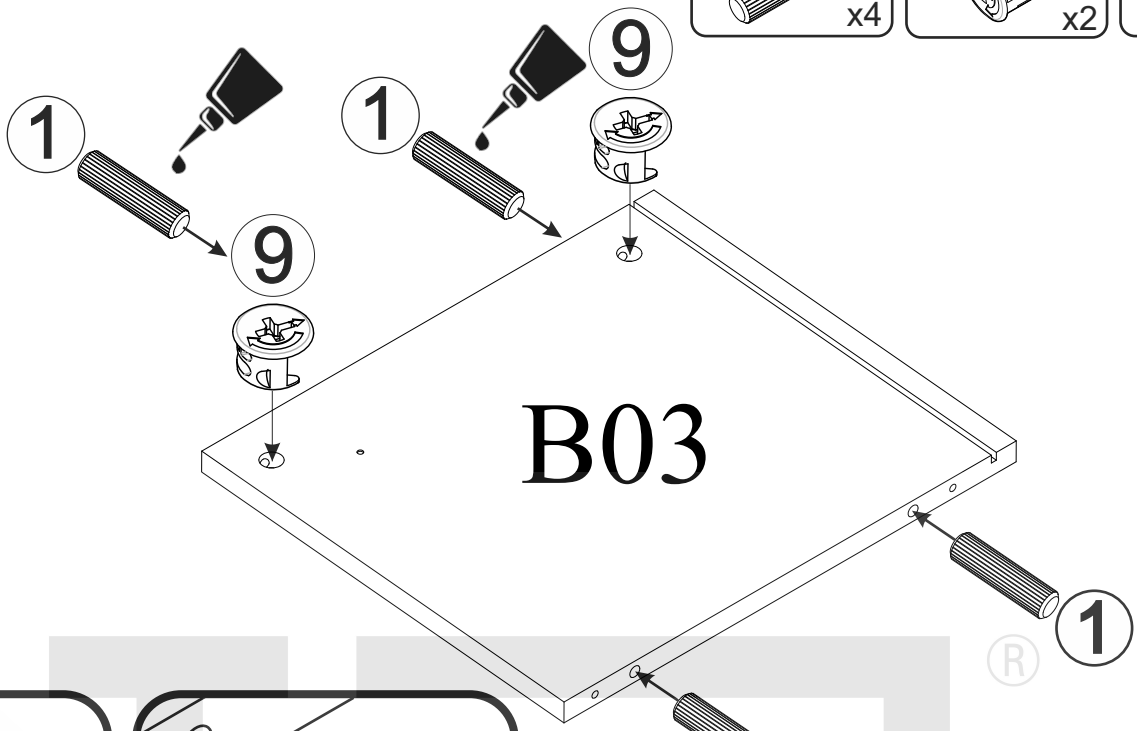
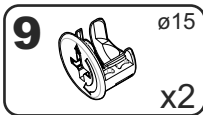
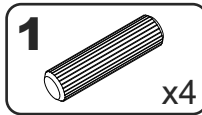

6

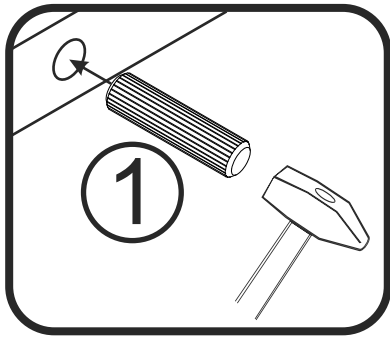
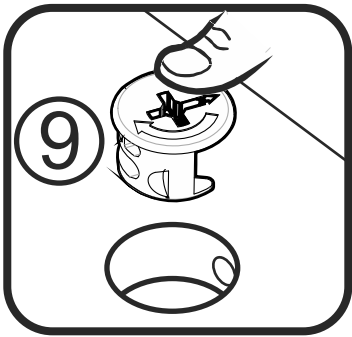
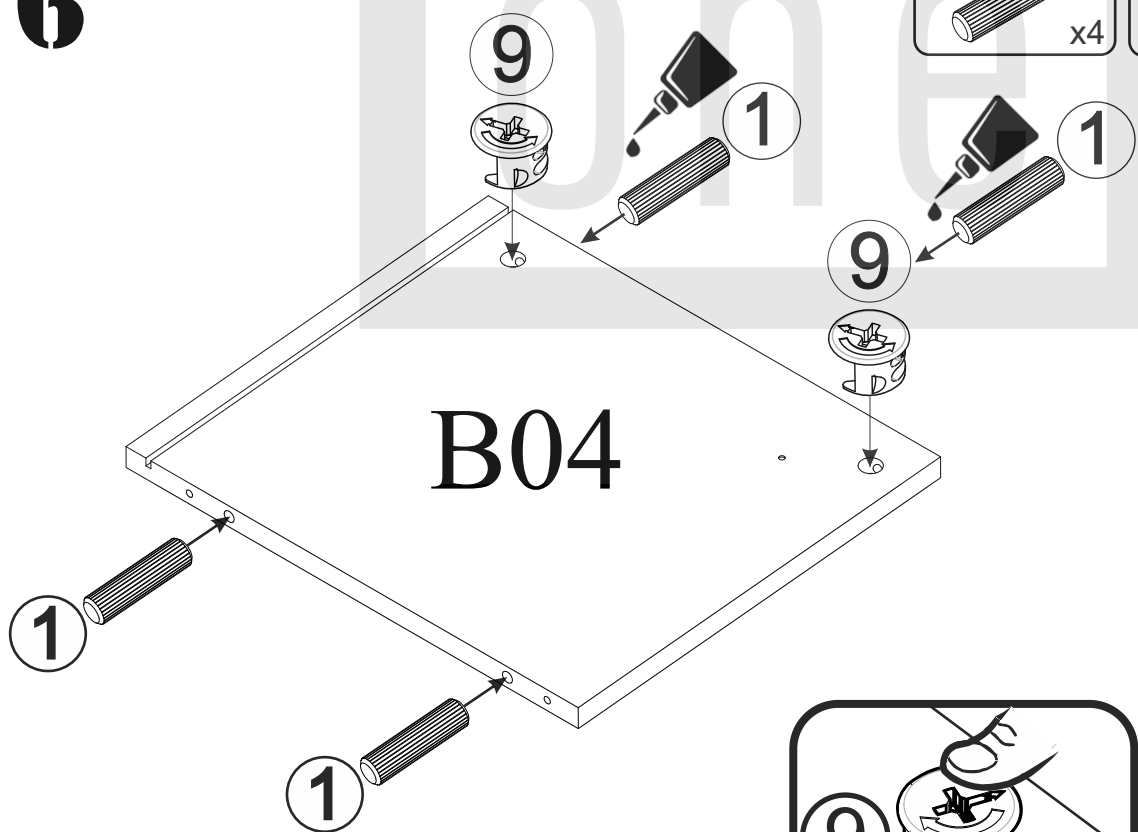
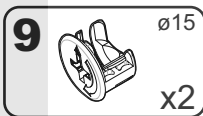
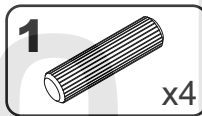

7

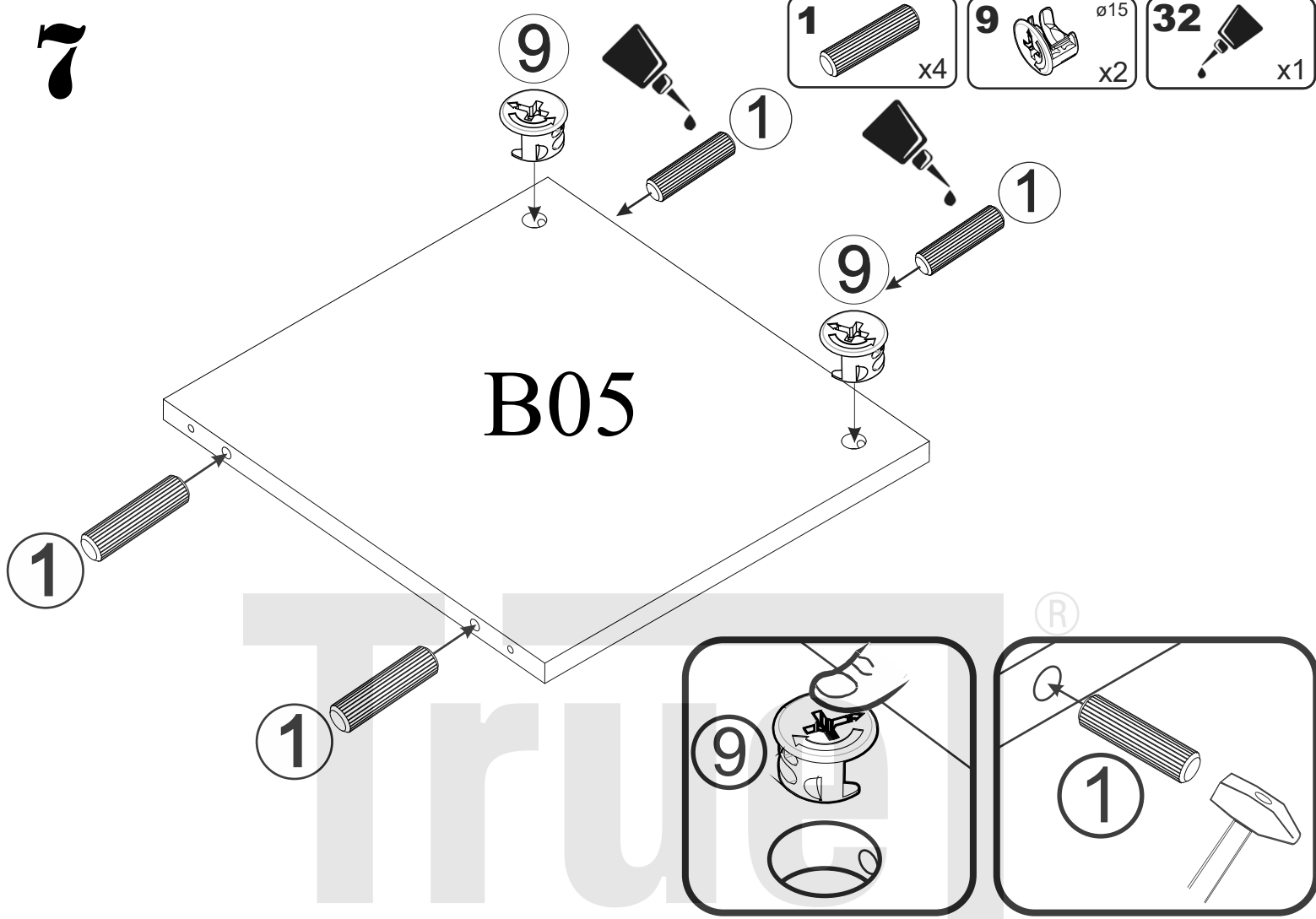

8

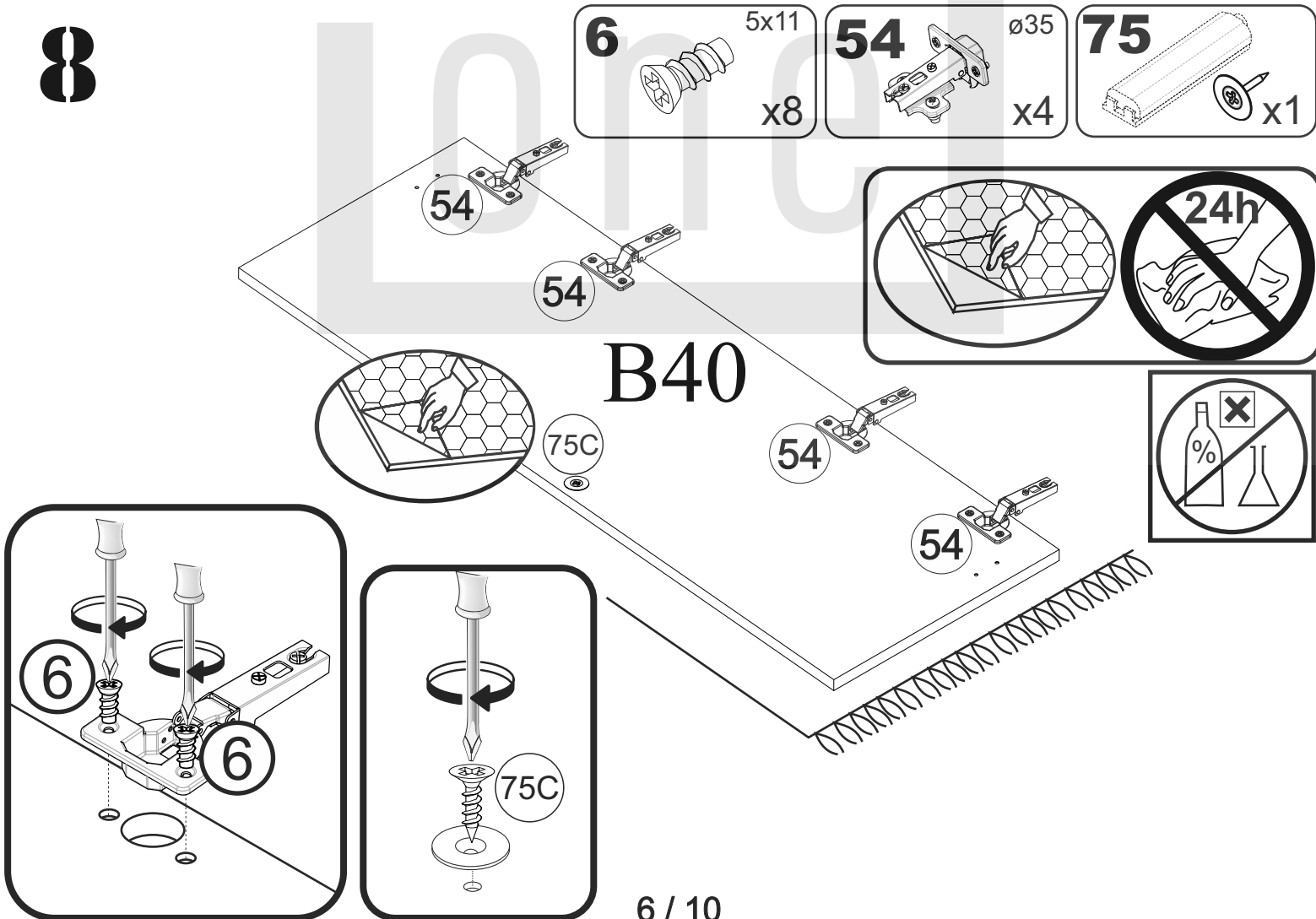

9

9A  x8

32  x1

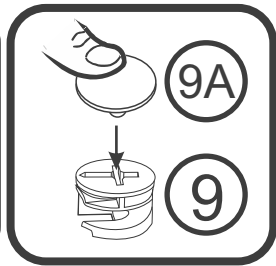
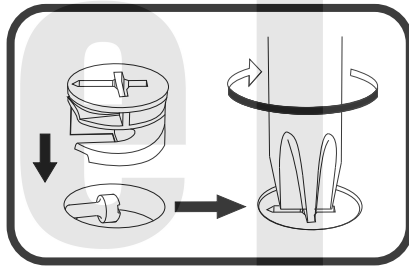
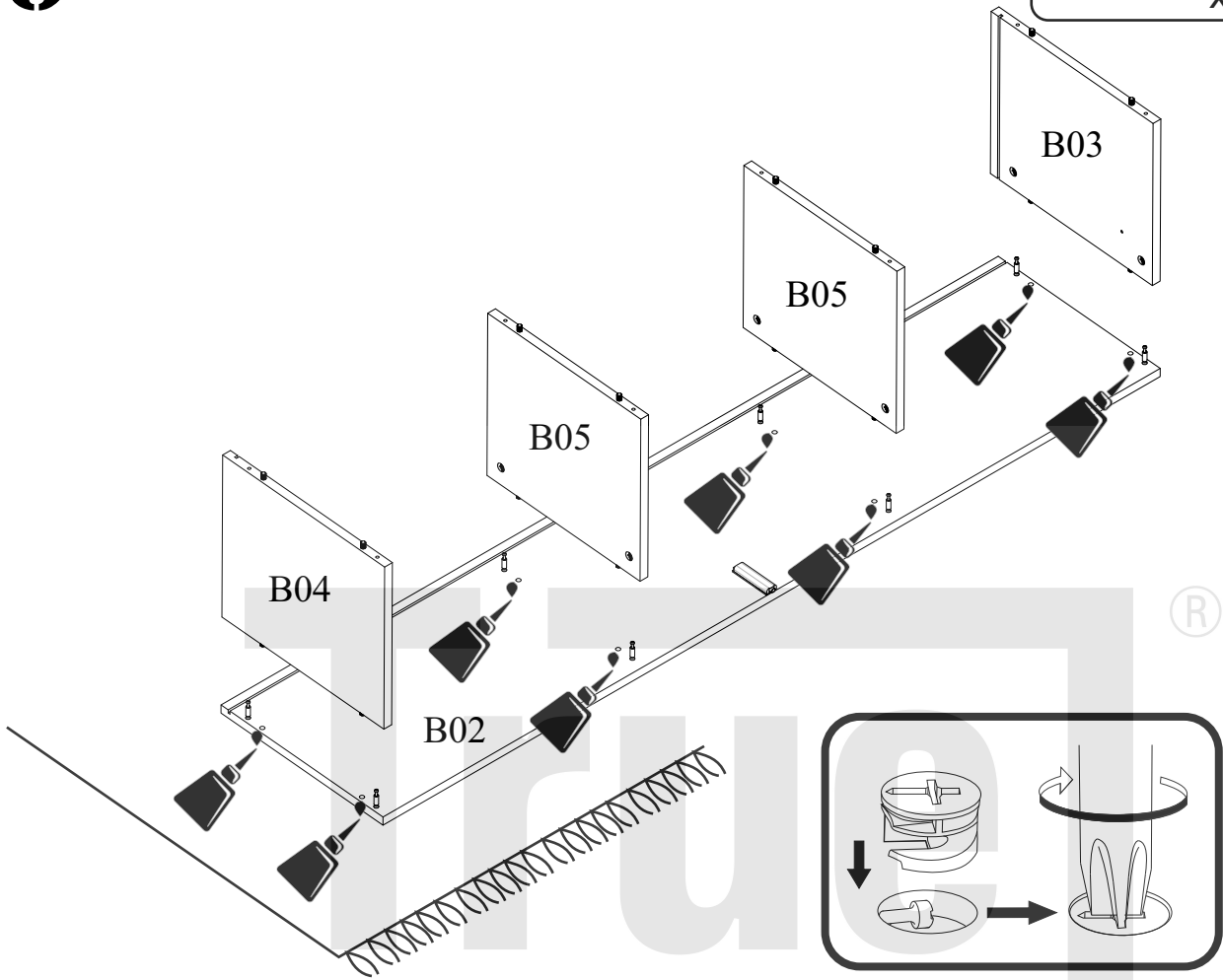

10

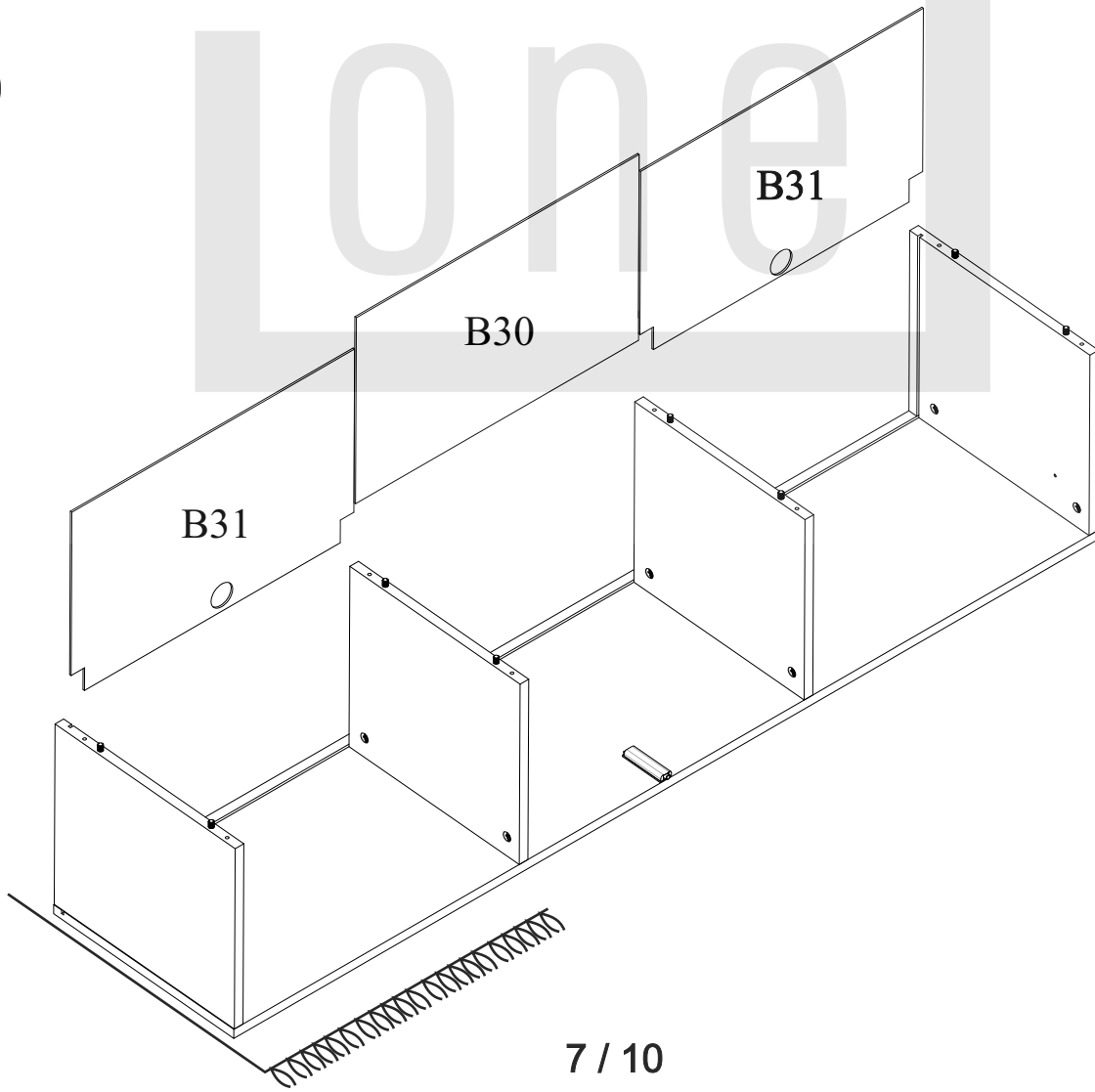

11

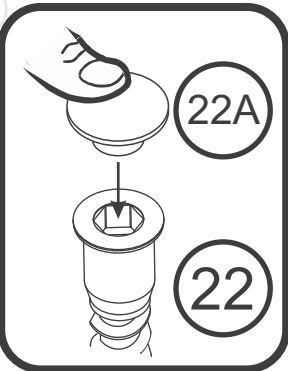
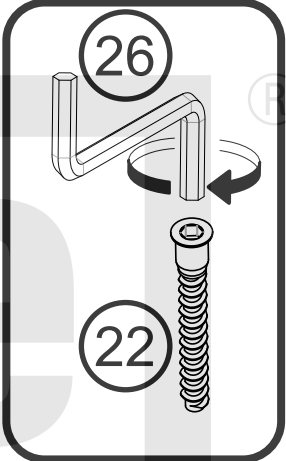
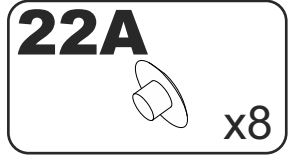
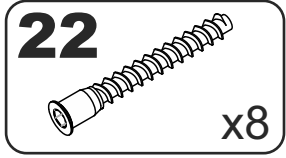
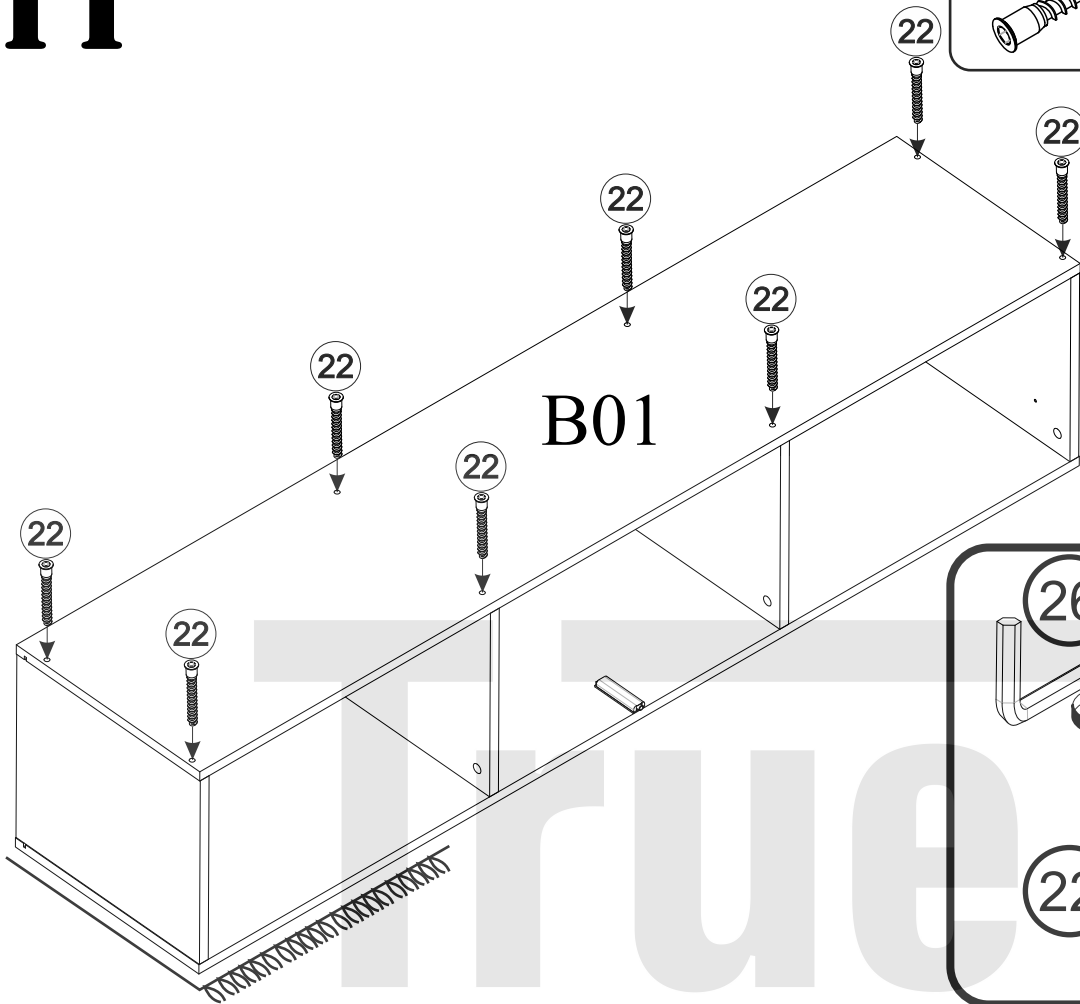

12

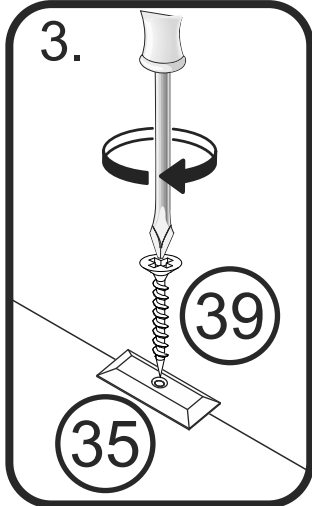
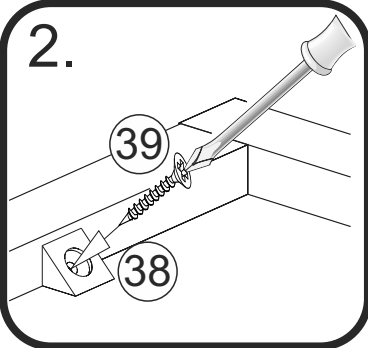
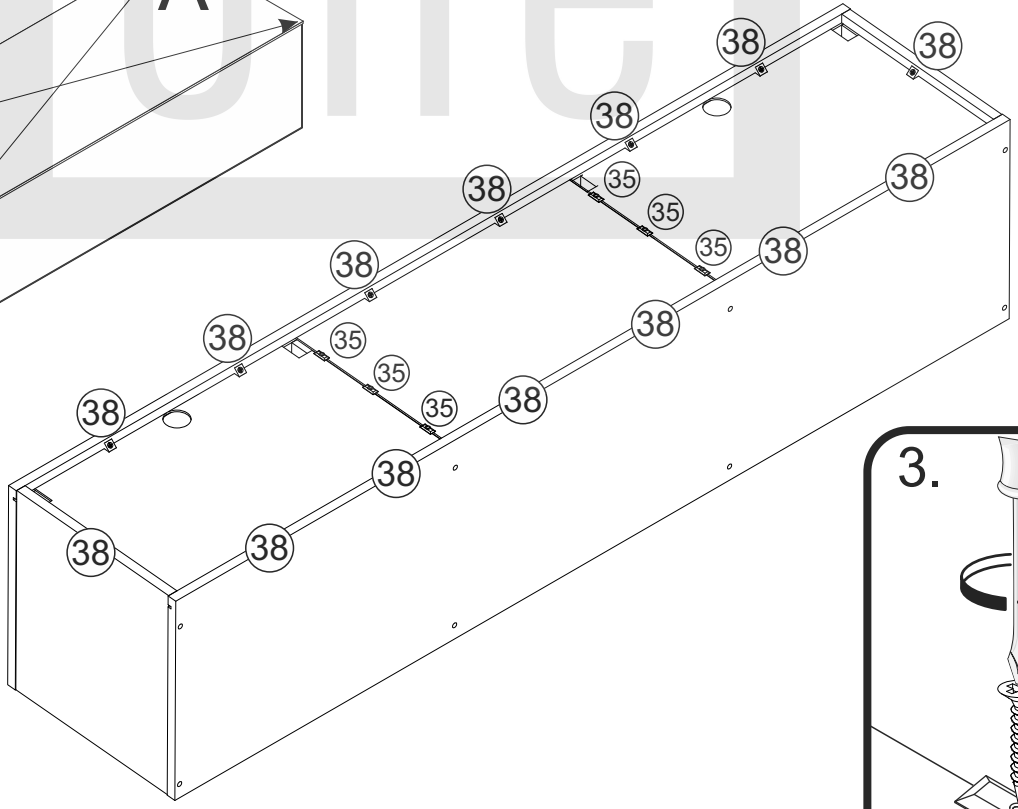
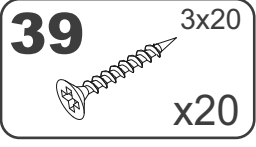
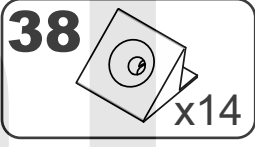
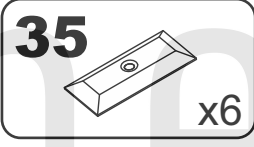
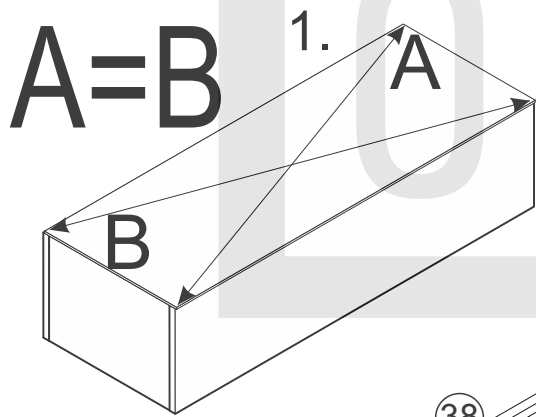

13

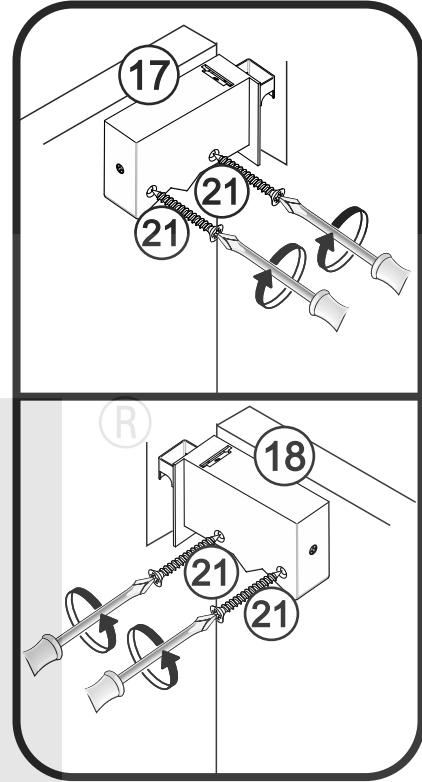
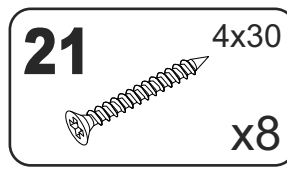
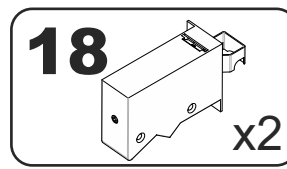
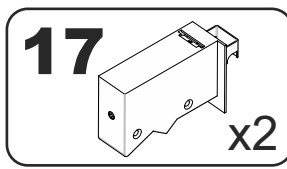
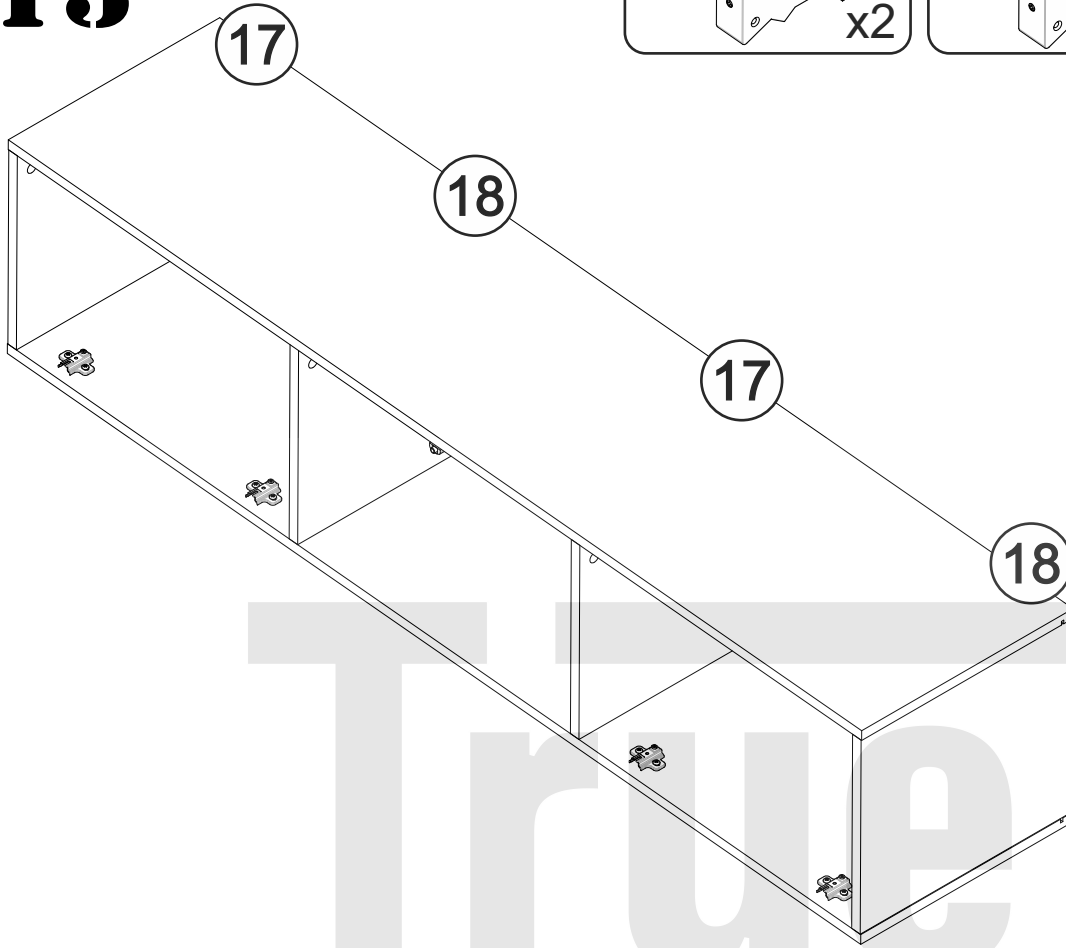

14

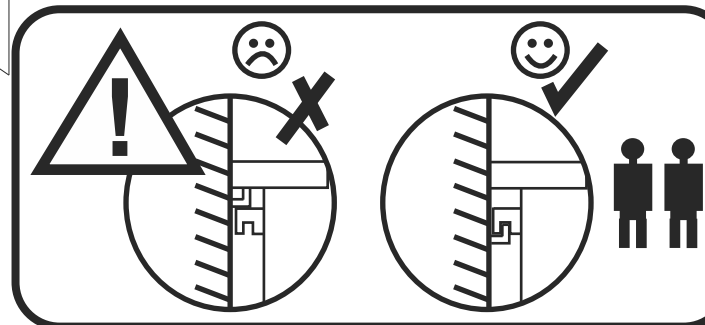
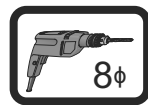
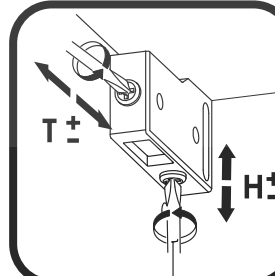
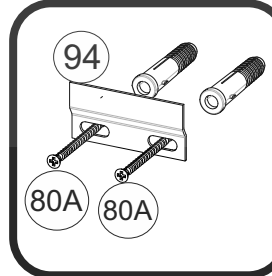
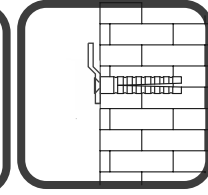
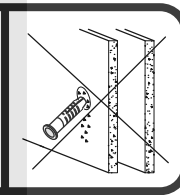
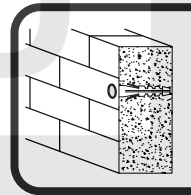
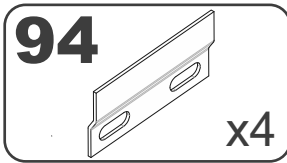
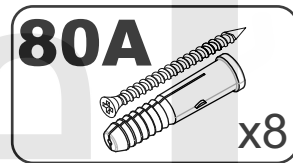
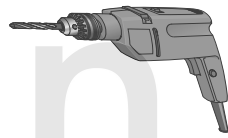
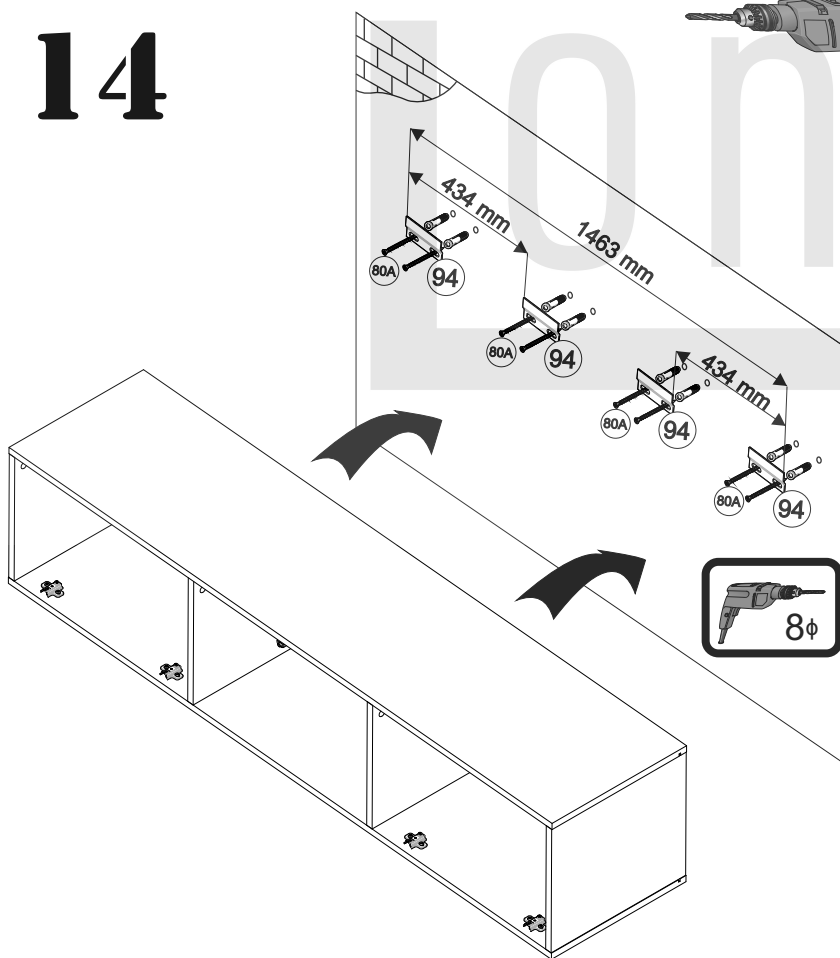

15

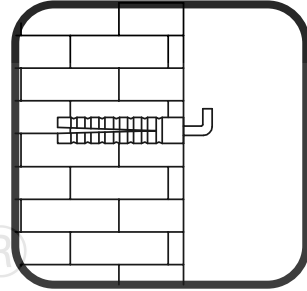
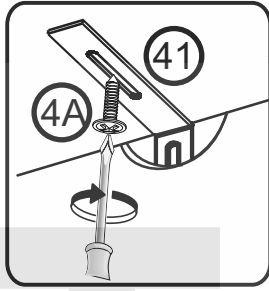
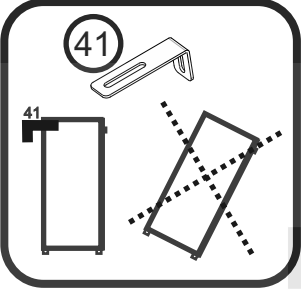
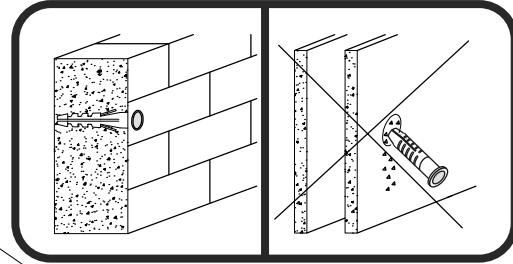
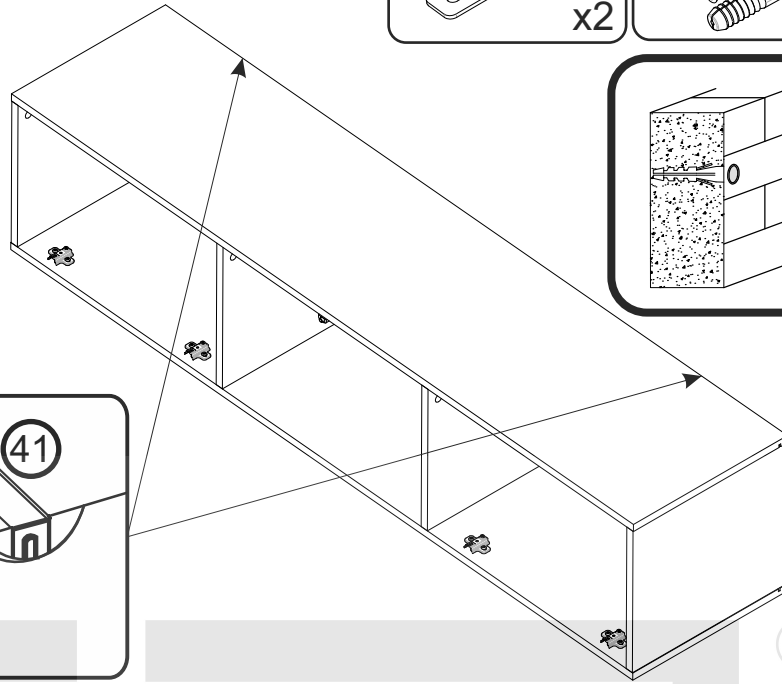
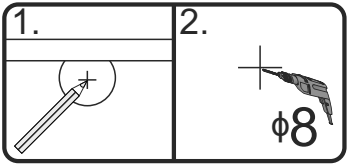
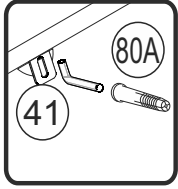
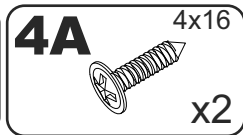
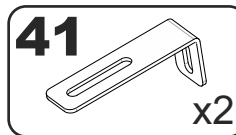

16

