

1

2

3

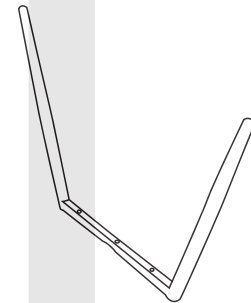
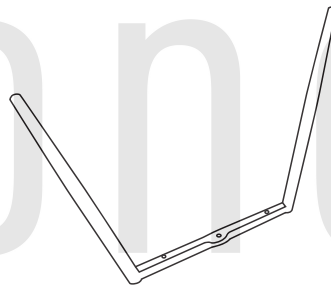
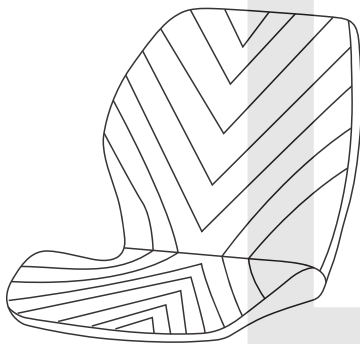

1	1x
2	1x
3	1x

A



M6x20mm

1x

B



M6x35mm

4x

C



Ø6xØ16x1.5

4x

D

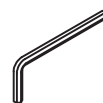

5MM

1x

①

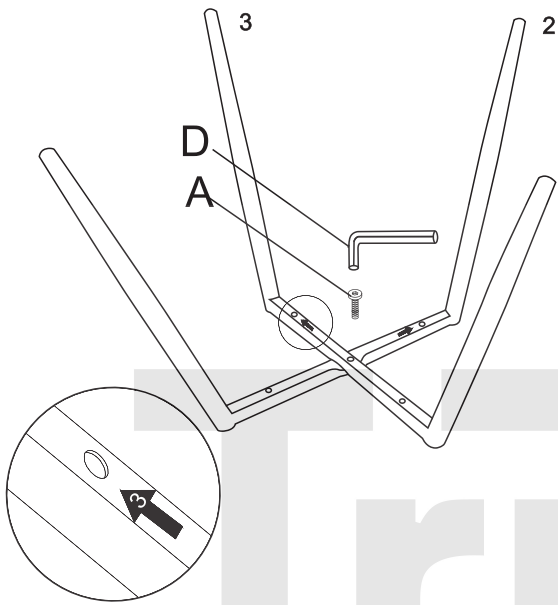

②

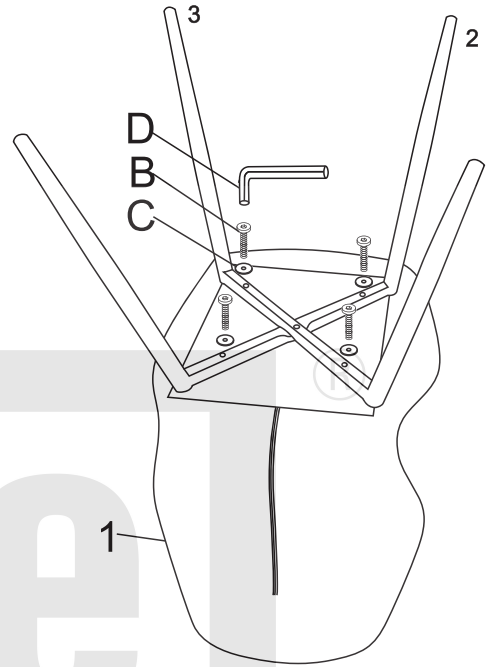
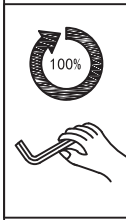

③

