

CALVIN FI 100

A-1PC

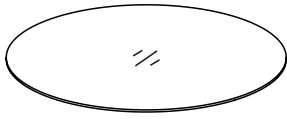

B-1PC

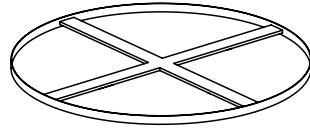

C-4PCS

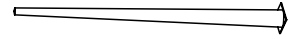

D-16PCS



E-16PCS



F-4PCS



G-1PC

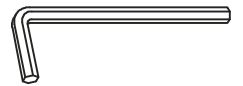

1

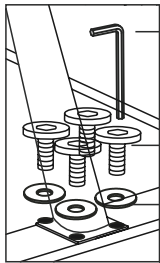

G

D

E

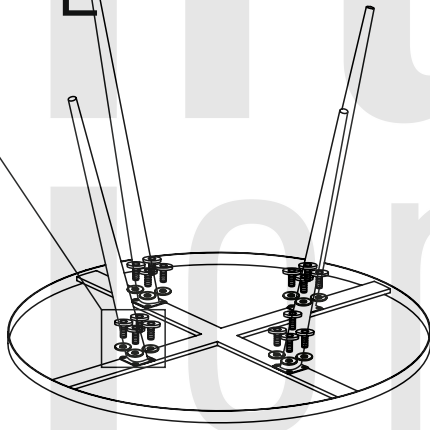

2

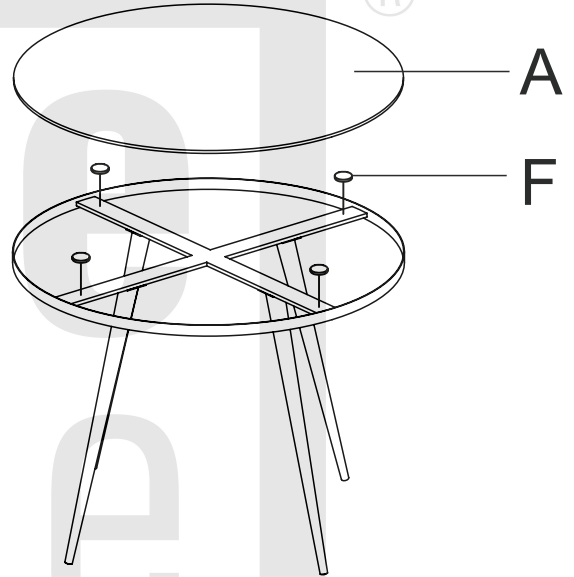

A

F

3

