

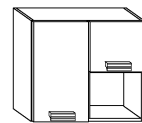

# SOL-08

## SOLO - SZAFKA WISZĄCA

► 60 ↑ 53 ↘ 31



WARIANTY MONTAŻU

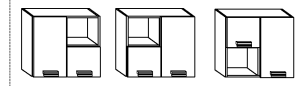

x 16



(a)

x 2



(b)

x 20



(c)

x 4

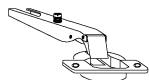

(d)

x 4

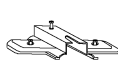

(e)

x 2

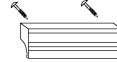

(f)

30 min

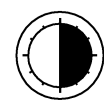

x 2 kpl.

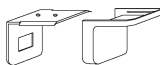

(g)

x 8 (4x16)



(h)

x 4  
(6,2x13)



(i)

x 30

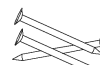

(j)

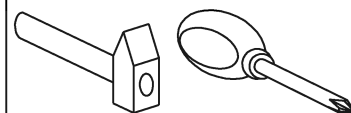

1 - FAZY MONTAŻU

A - OZNACZENIE ELEMENTÓW

a - OZNACZENIE AKCESORIÓW

1

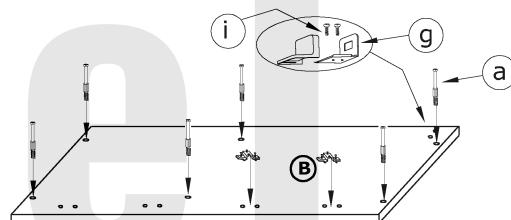
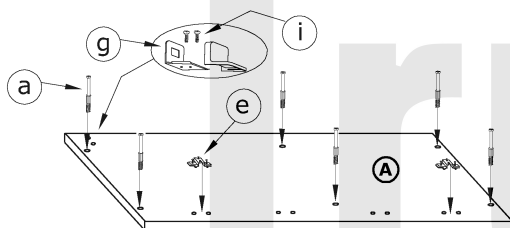

2

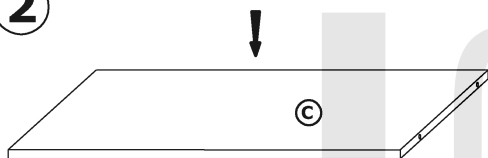

3

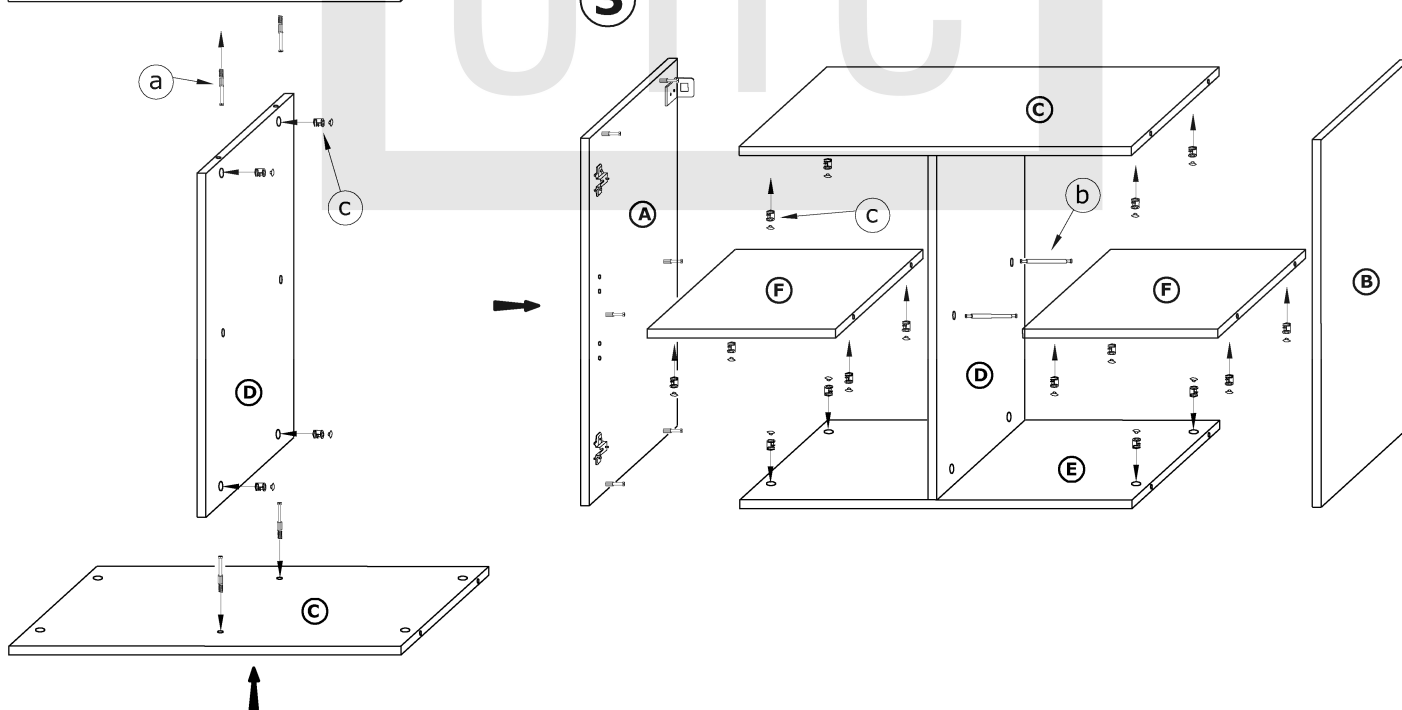

3

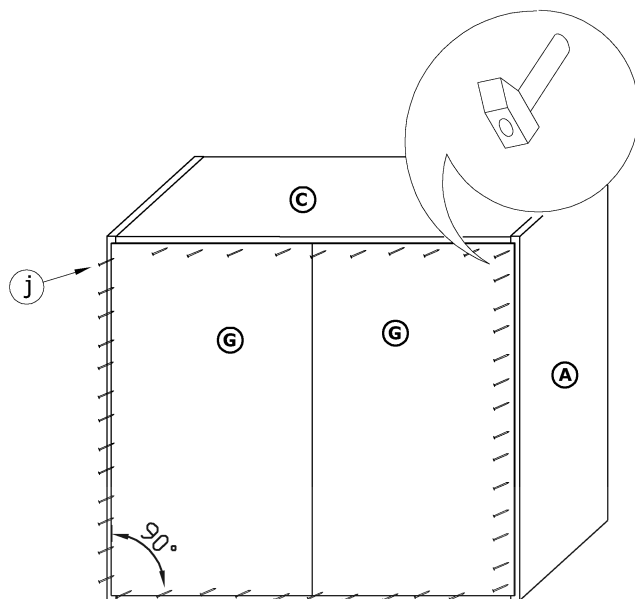

4

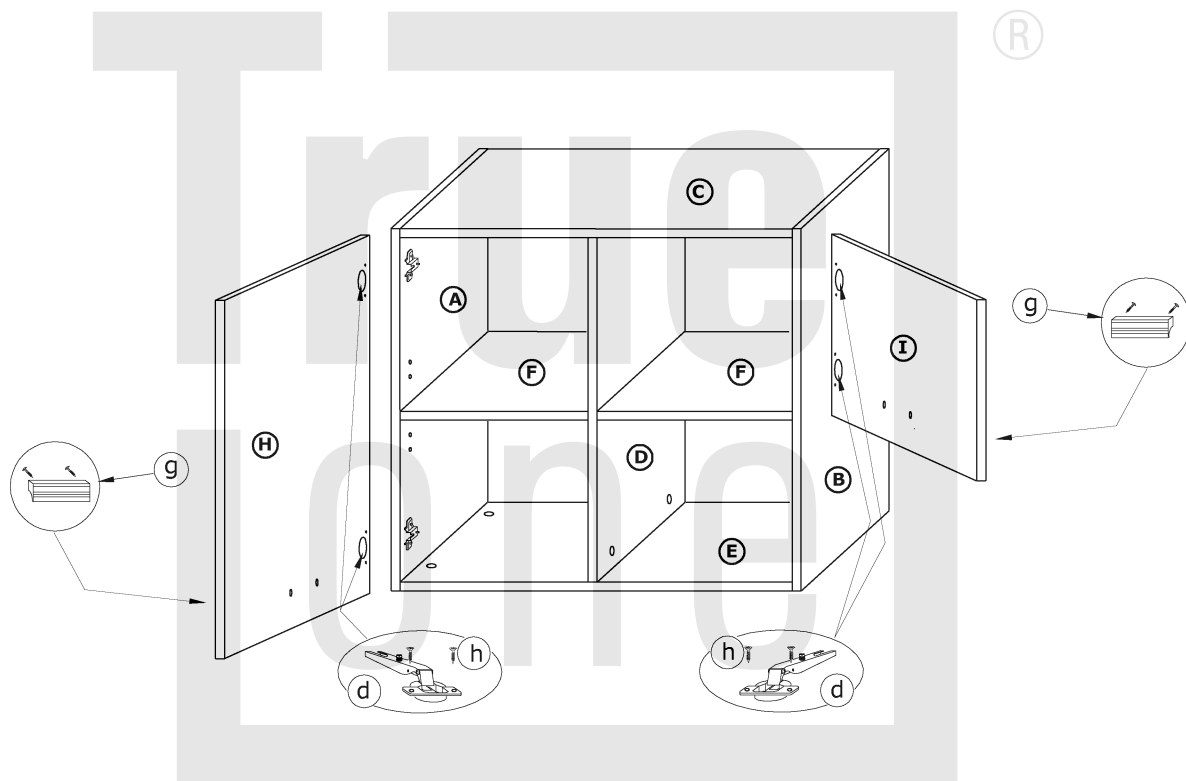

### WARIANTY MONTAŻU

