

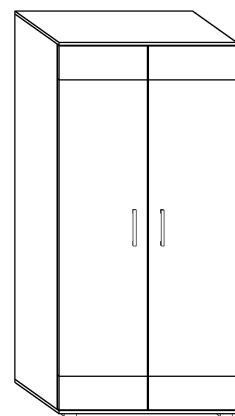

SLR-05 SOLAR - SZAFKA

→ 90 ↑ 190 ↘ 52



x 4

(a)

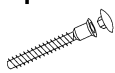

x 6

(b)

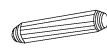

x 12

(c)

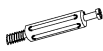

x 12

(d)



x 6

(e)

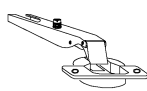

x 6

(f)

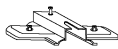

x 2

(g)



x 2

(j)



x 8
(4x20)

(k)

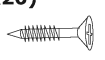

x 20
(3,5x16)

(l)



x 80

(m)

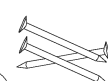

x 1

(n)



45 min



x 4

(h)

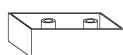

X 1 (862 mm)

(i)

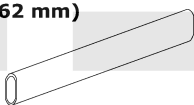

1 - FAZY MONTAŻU

A - OZNACZENIE ELEMENTÓW

a - OZNACZENIE AKCESORIÓW

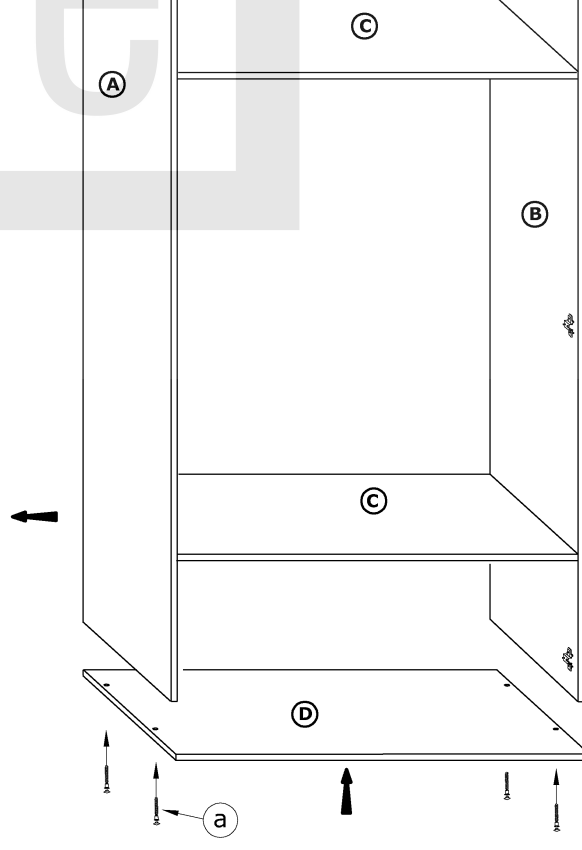
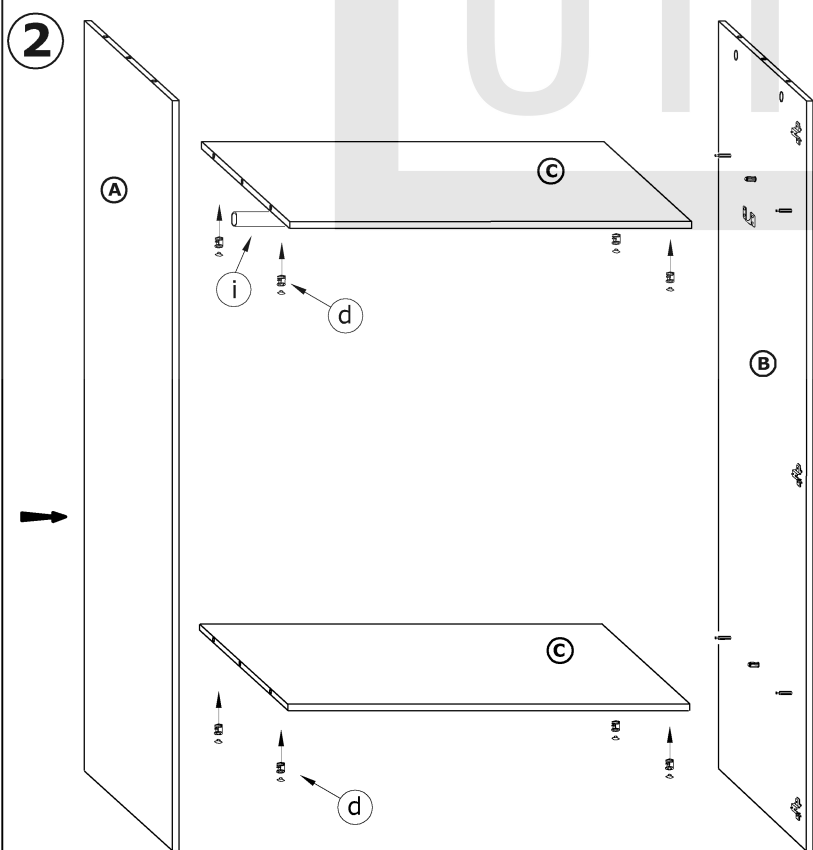
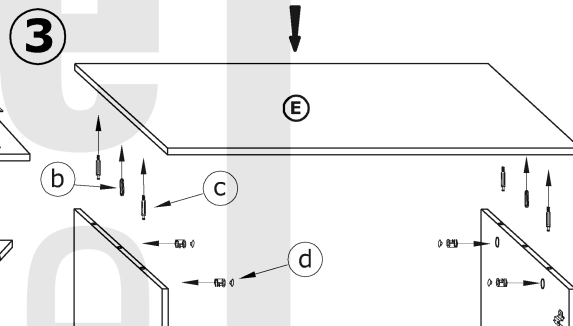
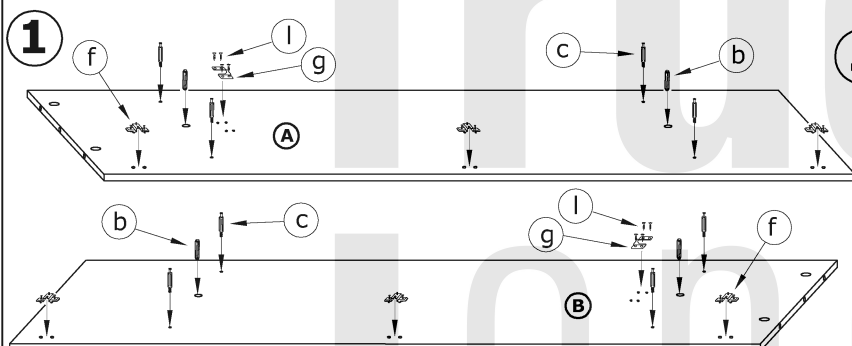

4

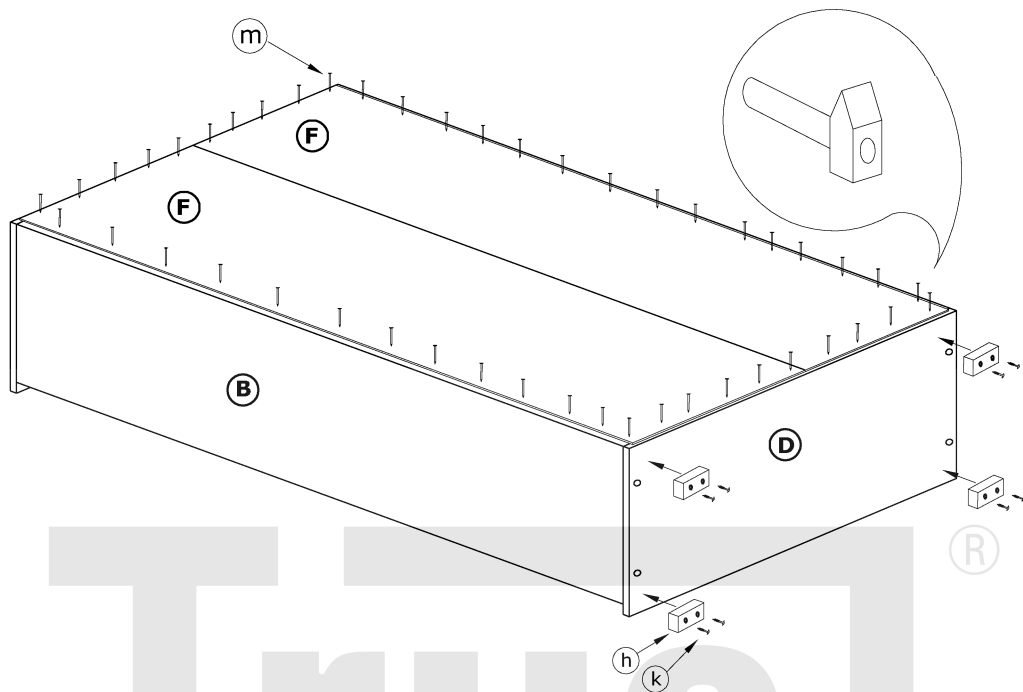

5

