

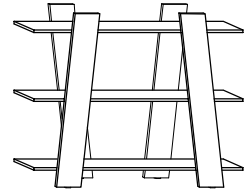

**VIA-03**  
**REGAŁ 130**  
 → 130 × 108 × 29



x 24



(a)

x 24



(b)

x 1



(c)

x 4



(d)

x 1

(3,5x16)



(e)

x 1

(120 mm)



(f)

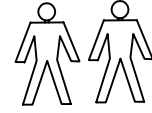

30 min

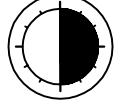

**1** - FAZY MONTAŻU

**A** - OZNACZENIE ELEMENTÓW

**a** - OZNACZENIE AKCESORIÓW

**1**

x 24



(a)

x 2

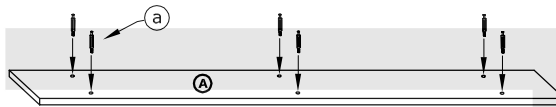

(R)

x 2

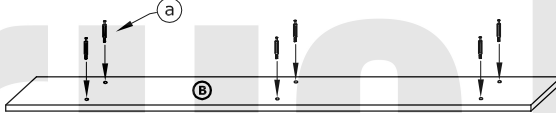

**2**

x 8

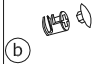

(b)

x 2



(d)

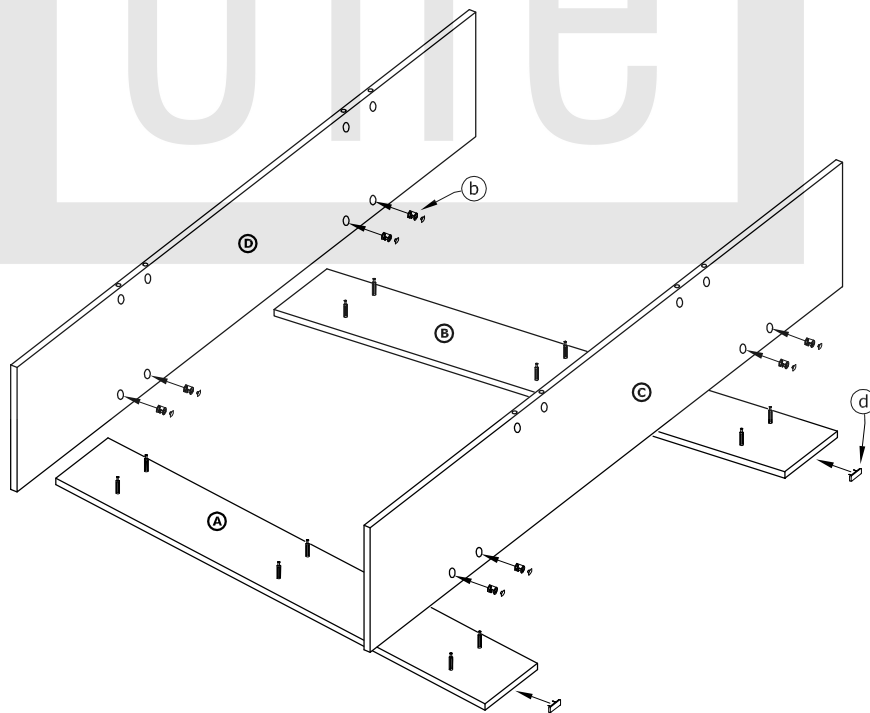

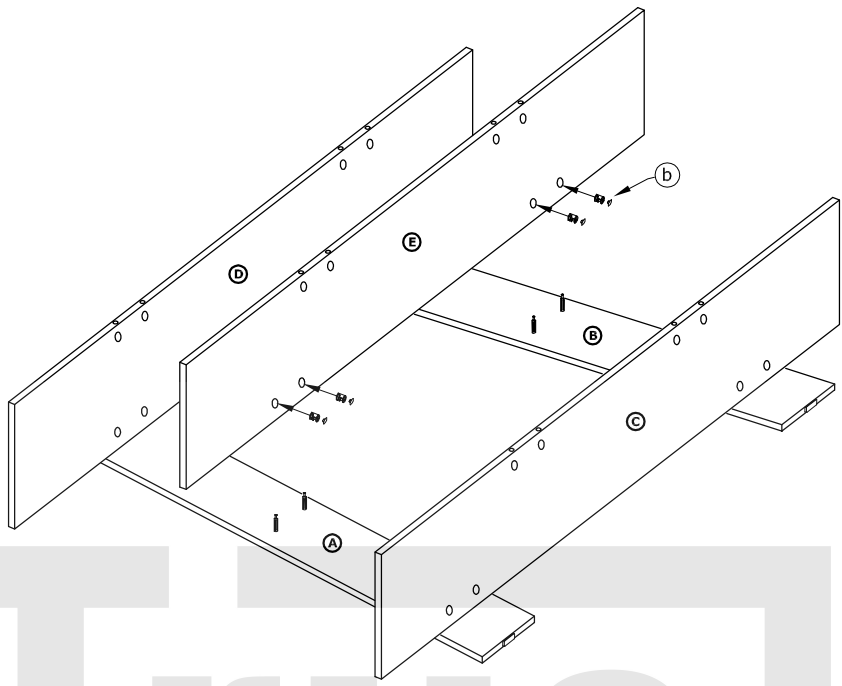

3

x 4

(b)



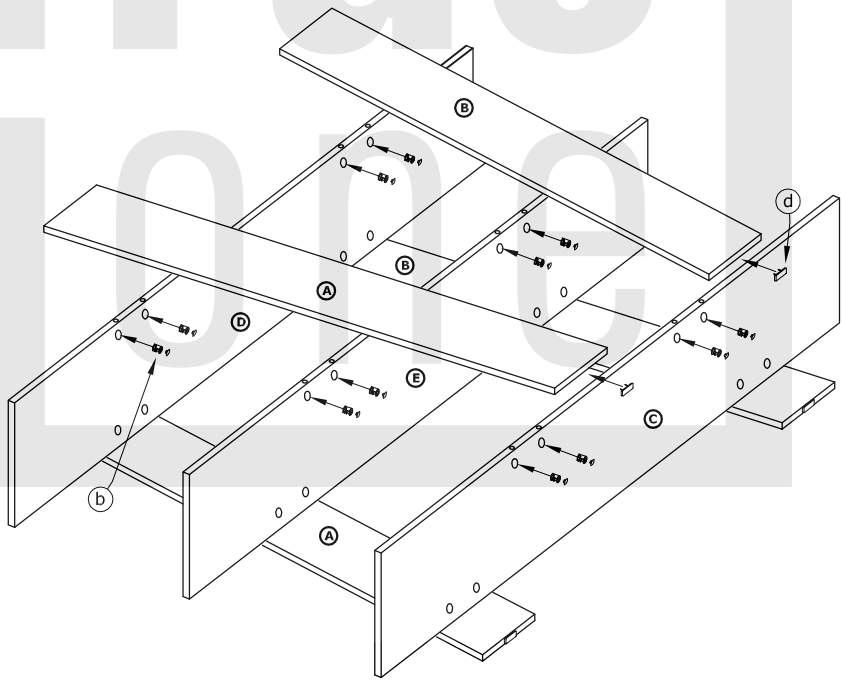

®

4

x 12	x 2
	
(b)	(d)



5

x 1	x 1	x 1
		
(c)	(e)	(f)

