

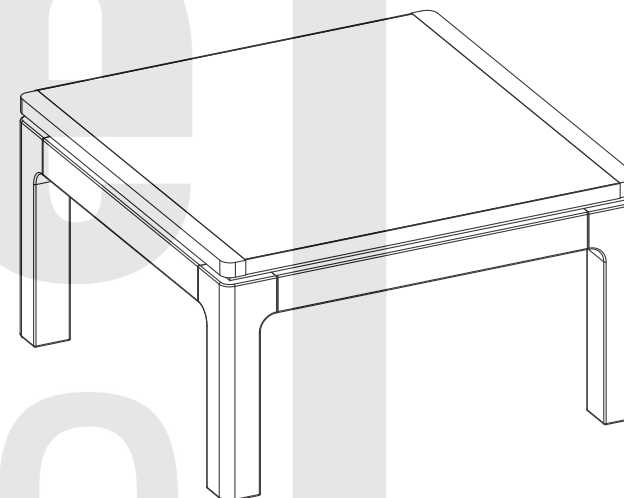

- (GB) Assembly instructions
- (DE) Montageanleitung
- (FR) Notice de montage
- (NL) Handleiding voor de montage
- (IT) Istruzioni di montaggio
- (HU) Szerelési útmutató
- (ES) Instrucciones de montaje
- (PL) Instrukcja montażu
- (CZ) Montážní návod
- (SK) Návod na montáž
- (HR) Montaže
- (TR) Montaj talimat
- (RO) Instrucțiuni de montaj
- (RU) Инструкции по монтажу

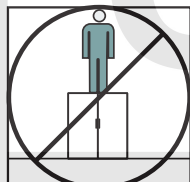

[https://www.szynaka.pl/pl/instrukcje\\_montazu](https://www.szynaka.pl/pl/instrukcje_montazu)

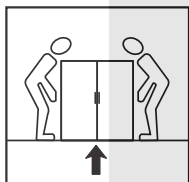
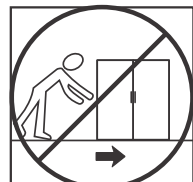
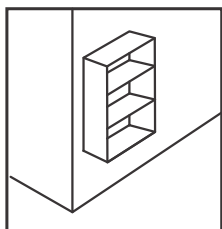
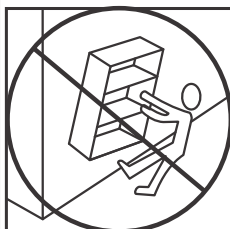

|    |    |    |    |    |    |    |
|----|----|----|----|----|----|----|
| Mo | Tu | We | Th | Fr | Sa | Su |
|    |    | 1  | 2  | 3  | 4  | 5  |
| 6  | 7  | 8  | 9  | 10 | 11 | 12 |
| 13 | 14 | 15 | 16 | 17 | 18 | 19 |
| 20 | 21 | 22 | 23 | 24 | 25 | 26 |
| 27 | 28 | 29 | 30 | 31 |    |    |

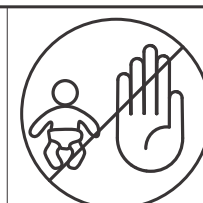
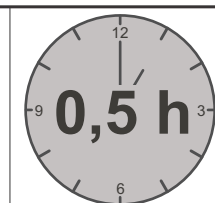
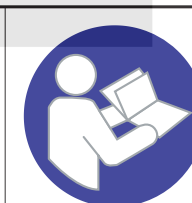
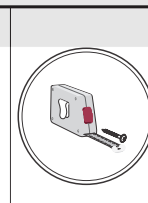
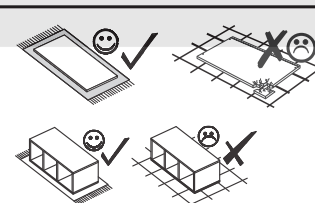
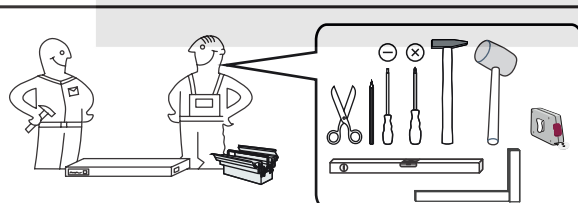
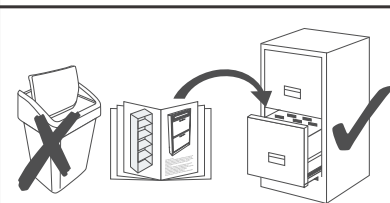

## Service • Assistenza • Dienstverlening • Serwis Servis • Szerviz • Servizio • Usluga • Нíđâčńńř • Нёёóář

|  |              |
|--|--------------|
| Name • Nom • Nome • Naam • Nazwa<br>Jméno • Názov • Név • Denumire<br>Nombre • Ime • Isim • Ířřarıřń | <b>PORTO</b> |
| Nr. • No. • N° • Ířěĺđ • Ć • Sz • Ne   |              |
| Typ • Type • Tip • Típus • Tipo • Нĉđ  | <b>41</b>    |
|  |              |
|  |              |

shop • geschäft • boutique • sklep • winkel • ёřřăřń  
negozio • bolt • tienda • obchod • dućan • mađaza • magazin

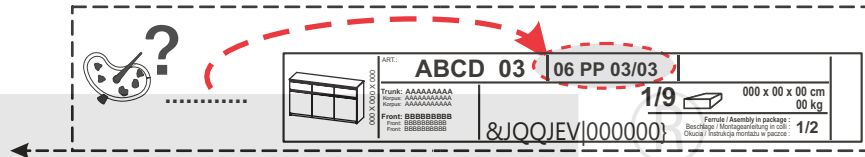
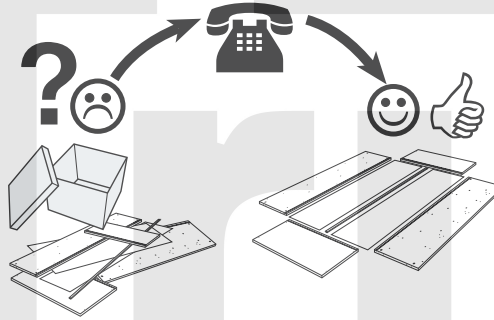

- G18** X...
- S16** 4x50 X...
- S11** 4x25 X...
- B1** fi 10x50 X...
- T25** X...
- M13** X...

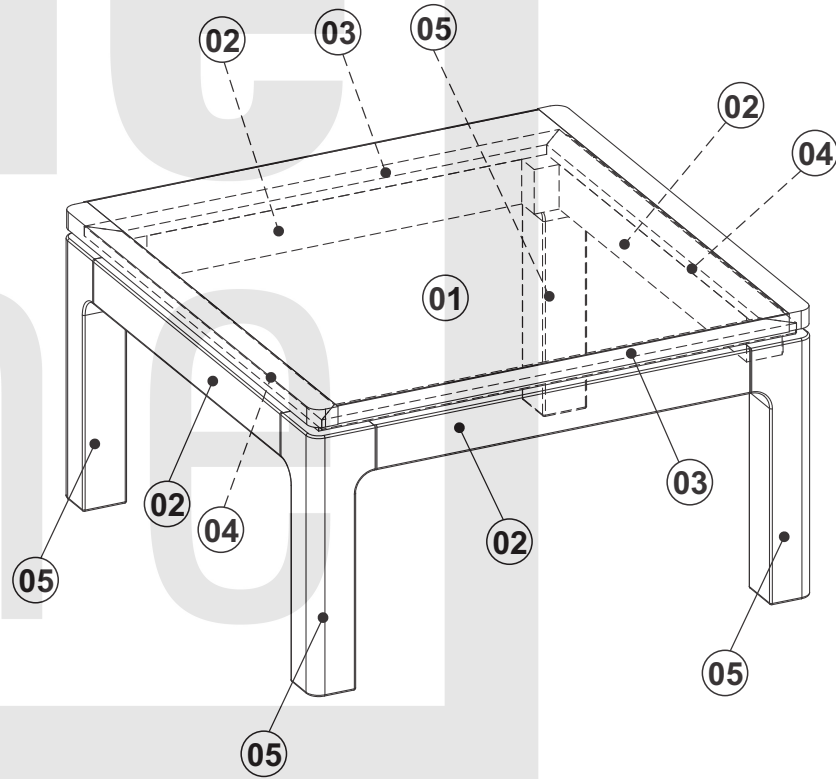

max.  
**10KG** **01**







