

x 3

(a)

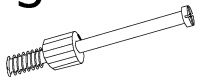

x 3

(b)

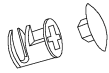

x 6

(c)

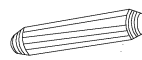

x 6 (3,5x16)

(d)



x 3

(e)



x 3

(f)



15 min

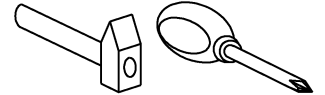
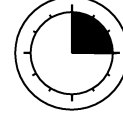

1 - FAZY MONTAŻU

A - OZNACZENIE ELEMENTÓW

a - OZNACZENIE AKCESORIÓW

1

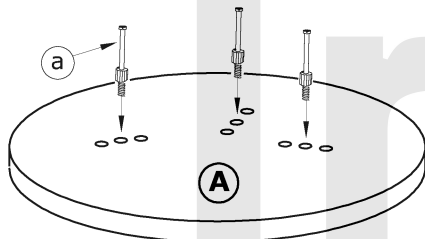

2

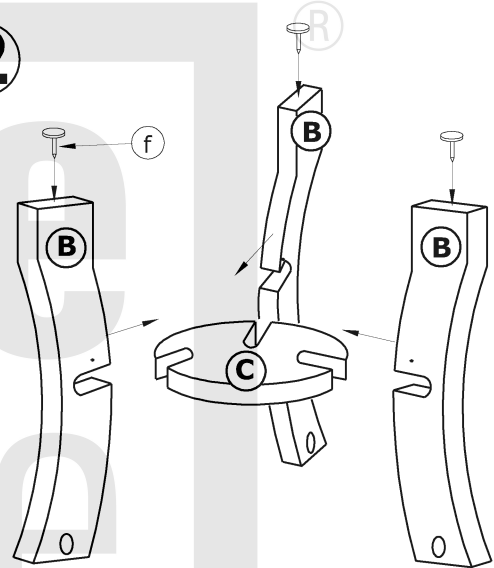

3

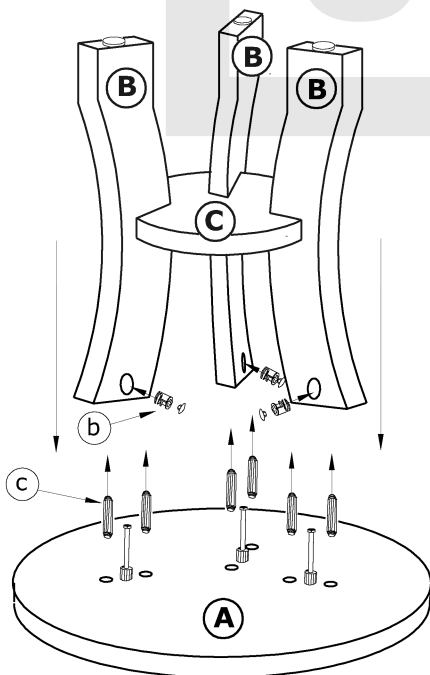

4

