



(GB) Assembly instructions

(PL) Instrukcja montażu

(DE) Montageanleitung

(CZ) Montážní návod

(FR) Notice de montage

(SK) Návod na montáž

(NL) Handleiding voor de montage

(HR) Montat'e

(IT) Istruzioni di montaggio

(TR) Montaj talimat

(HU) Szerelési útmutató

(RO) Instrucțiuni de montaj

(ES) Instrucciones de montaje

(RU) Инструкции по монтажу

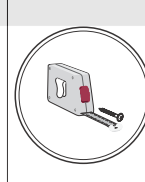
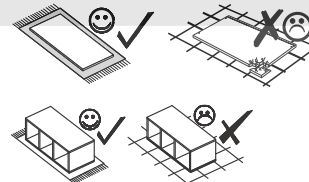
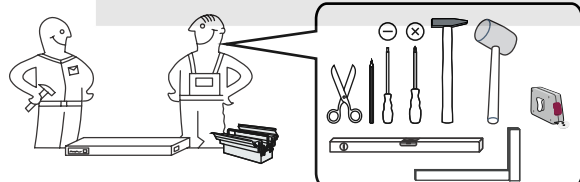
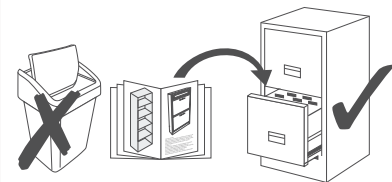
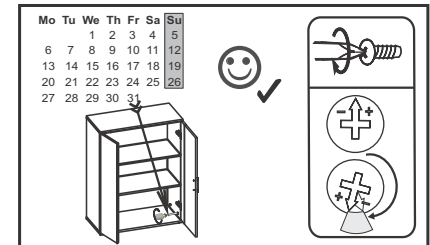
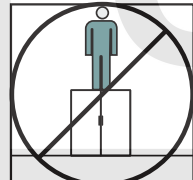
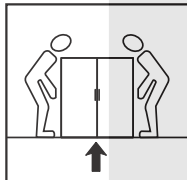
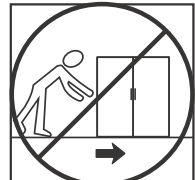
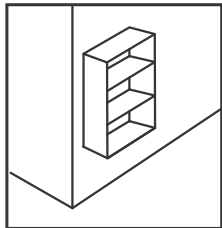
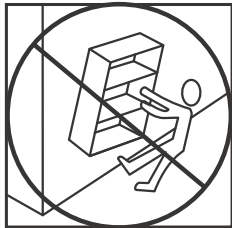
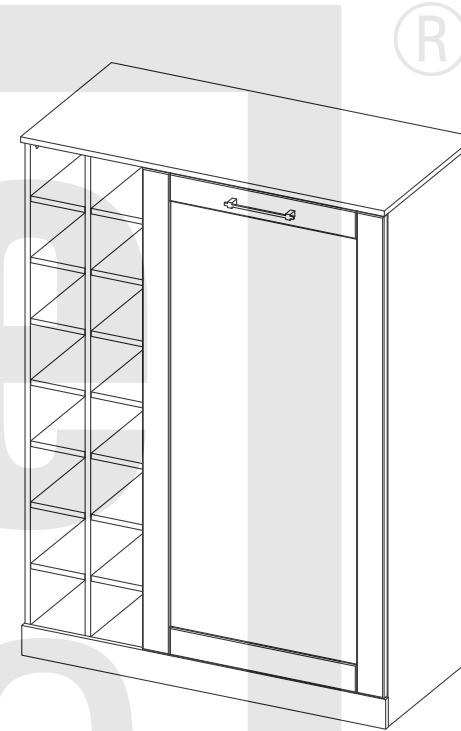

## Service • Assistenza • Dienstverlening • Serwis Servis • Szerviz • Servizio • Usluga •

Name • Nom • Nome • Naam • Nazwa Jméno • Názov • Név • Denumire Nombre • Ime • Isim	<b>COZY</b>
Nr. • No. • N° • říeřď • Ć • Sz • Ne	
Typ • Type • Tip • Típus • Tipo	<b>15</b>

shop • geschäft • boutique • sklep • winkel •  
negozio • bolt • tienda • obchod • dučan • mađaza • magazin

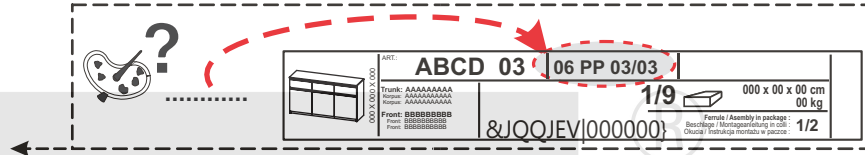
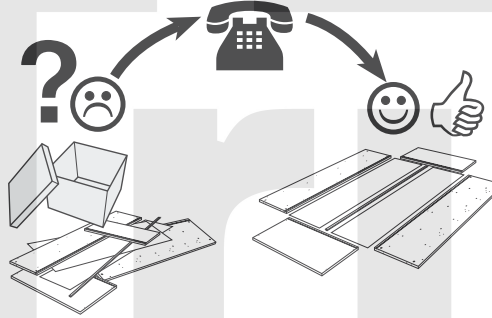

<b>M1</b> X...	<b>F1</b> X...
<b>T1</b> X...	<b>W10</b> X...
<b>B1</b> fi 8x28 X...	<b>K5</b> X...
<b>Z25</b> fi 35 KR0 X...	<b>P2</b> 3x16 X...
<b>Z25s</b> fi 35 KR0 X...	<b>F10</b> X...
<b>S9</b> 4x16 X...	<b>G1</b> X...
<b>D22</b> H0 X...	<b>P10</b> 3x13 X...
<b>J23</b> X...	

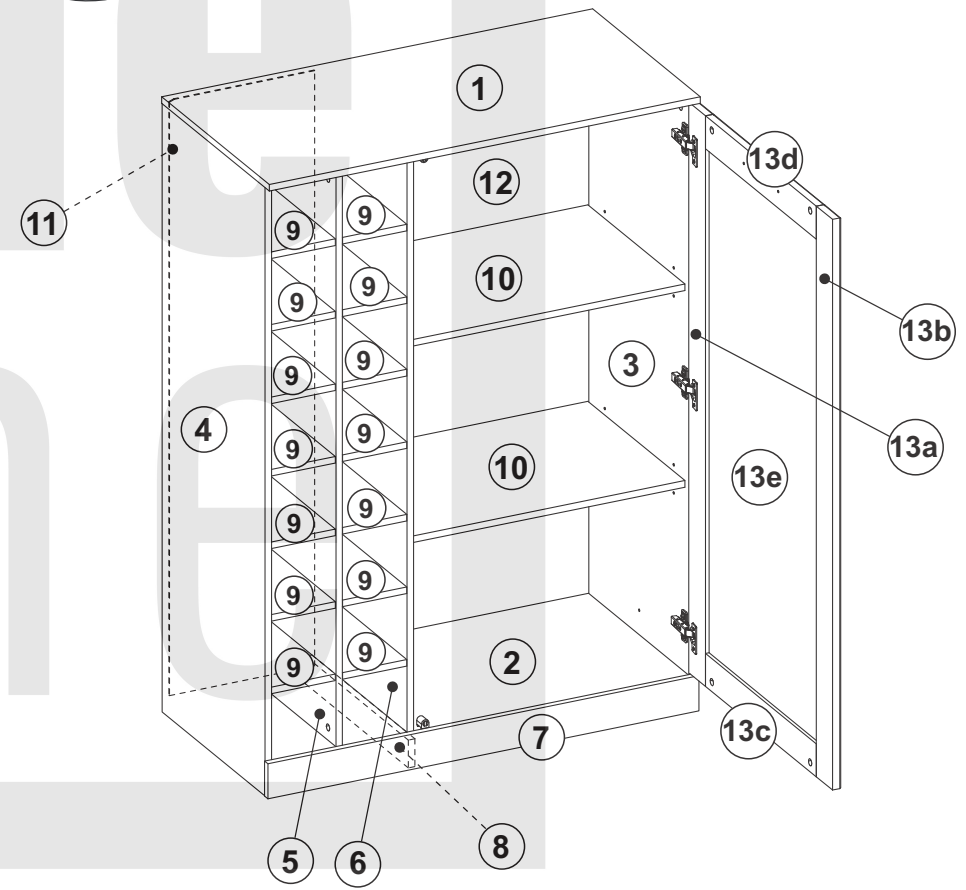

# 1

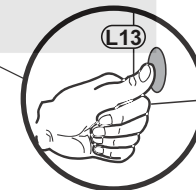
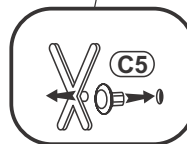
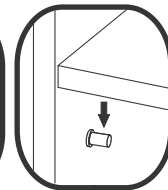
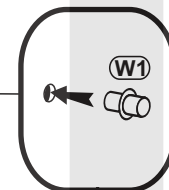
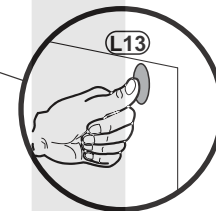
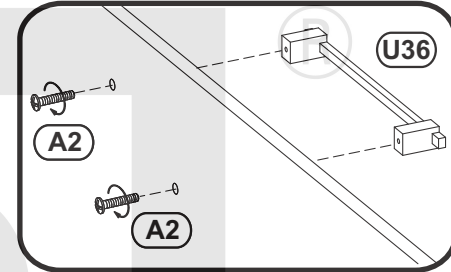
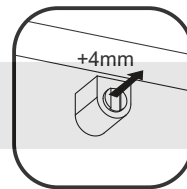
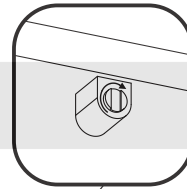
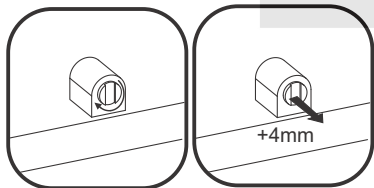
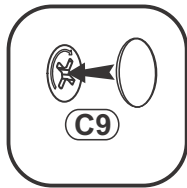
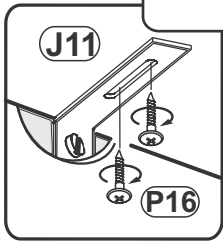
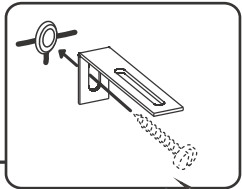

**W1** x8

**C9** x46  
fi 20

**C5** x2  
fi 5

**L13** x2  
SJ

**J11** x1

**P16** x2  
4x16

**U36** x1

**A2** x2  
M4x25

