

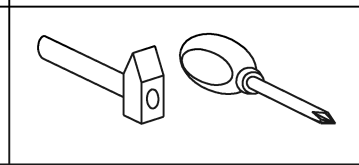

# MAX-STOLIK RTV

→ 160 ↑ 39 ↘ 40

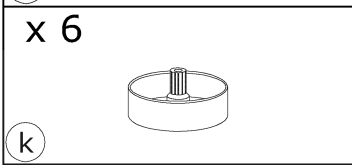
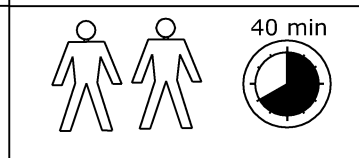
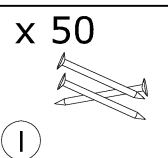
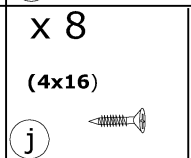
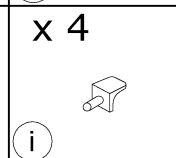
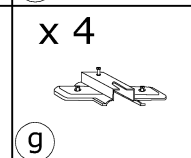
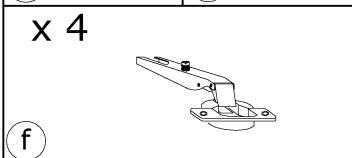
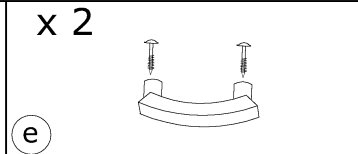
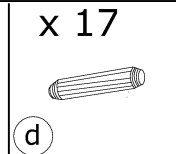
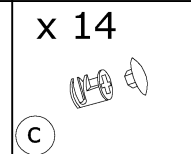
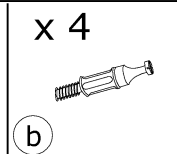
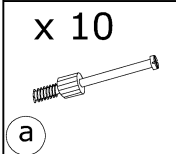
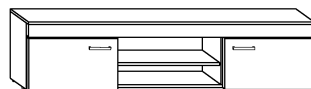

**1** - FAZY MONTAŻU

**A** - OZNACZENIE ELEMENTÓW

**a** - OZNACZENIE AKCESORIÓW

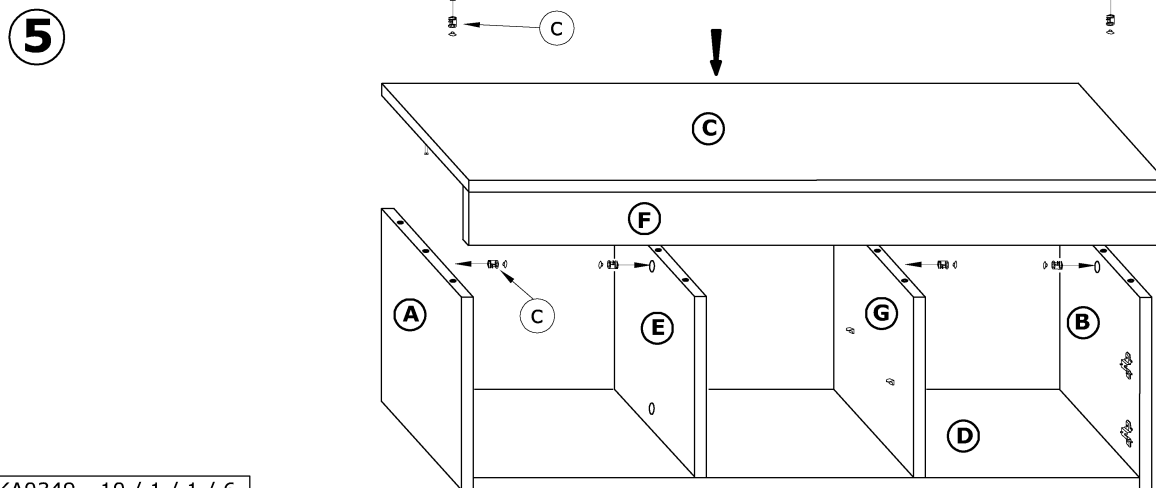
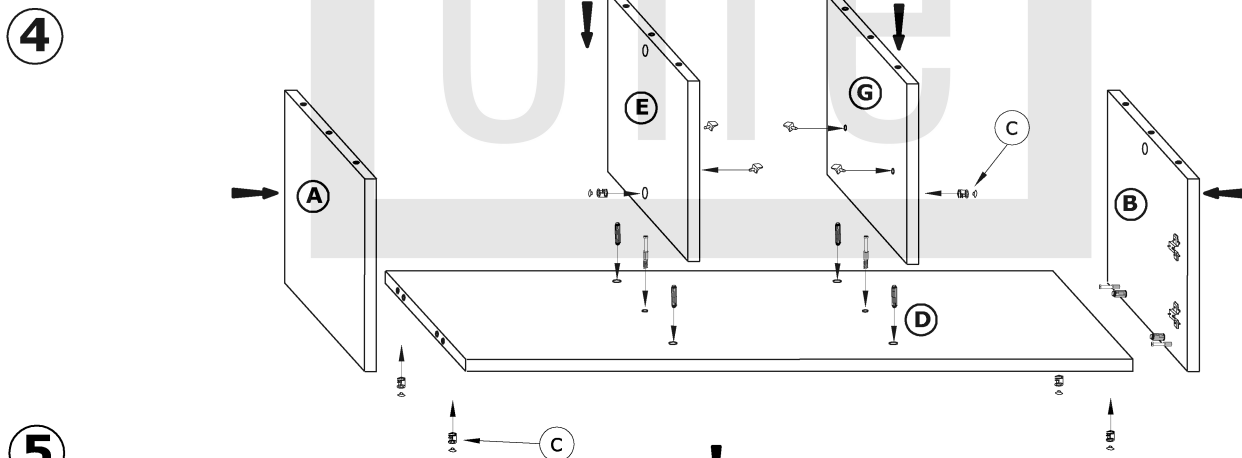
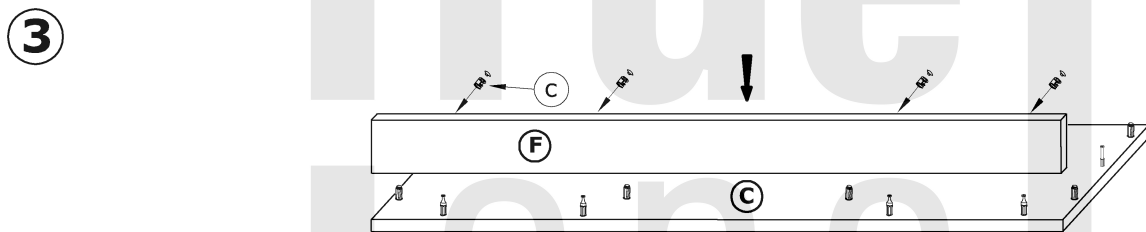
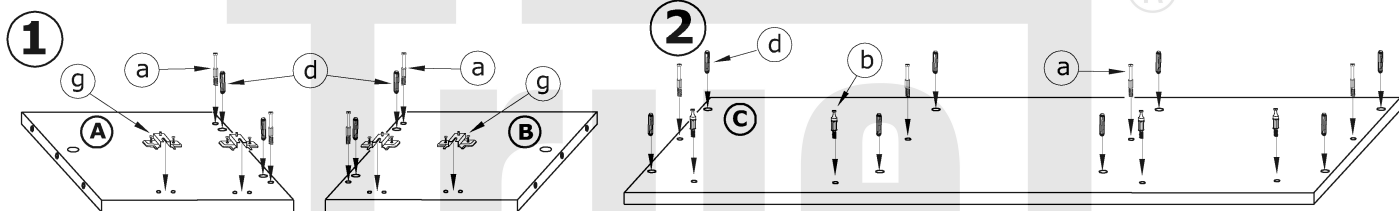

6

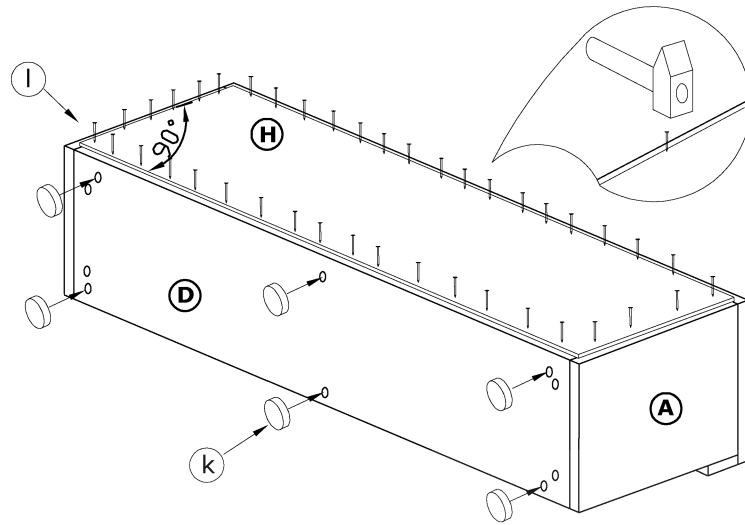

7

