

# KORA

# 7

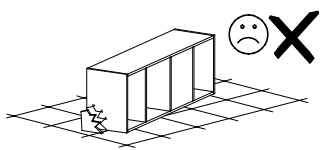

Narzędzia potrzebne do montażu

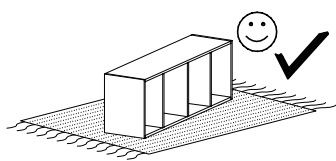
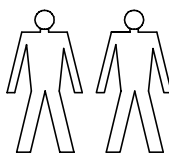
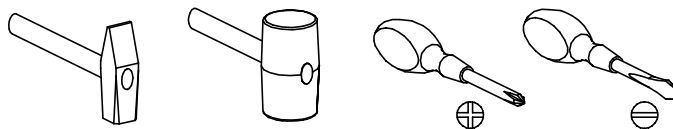

## UWAGA !!

MONTOWANIE USZKODZONYCH  
ELEMENTÓW POWODUJE UTRATĘ  
GWARANCJI

nr	D[mm]	S[mm]	G[mm]	Ilość
1	1607	450	65	1
2	1607	450	65	1
3	830	410	16	1
4	830	410	16	1
5	830	410	16	1
6	830	410	16	1
8	1537	426	2,5	2
9	432	380	16	2
10	771	450	16	1
11	771	450	16	1
12	635	190	16	4
13	350	150	16	4
14	350	150	16	4
15	560	150	16	4
16	590	355	2,5	4

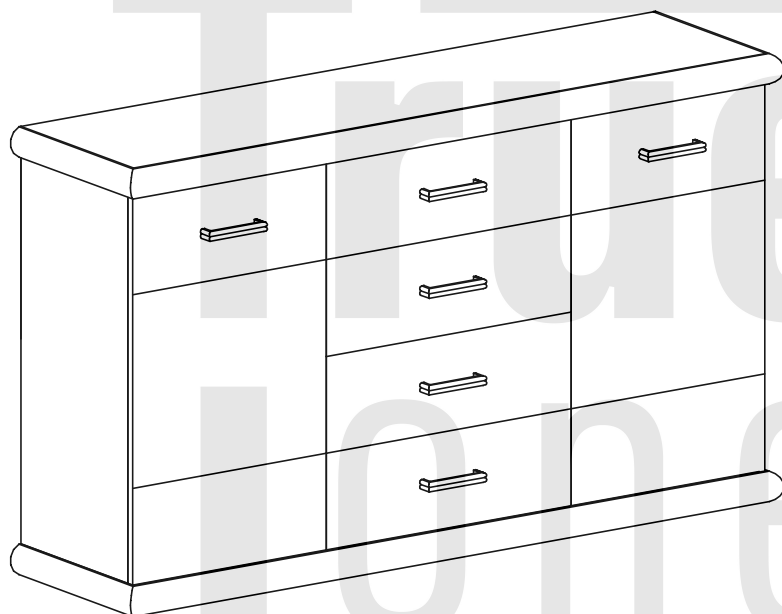

## UWAGA !!

Mebel zawiera  
elementy drewniane

W przypadku reklamacji proszę o podanie numeru pakowacza znajdującego się na kartonie

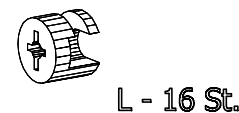
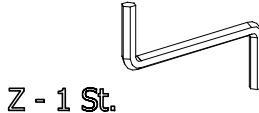
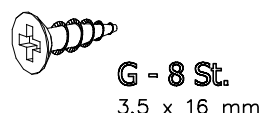
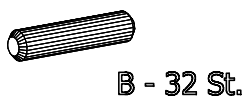
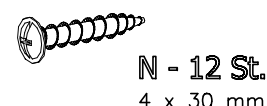
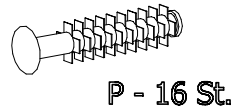
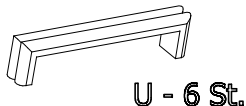
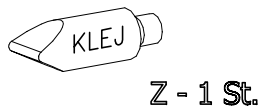
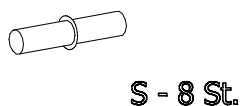
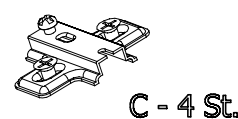
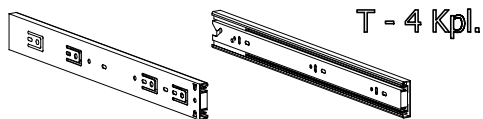
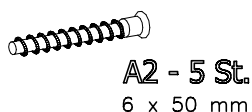
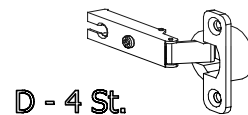
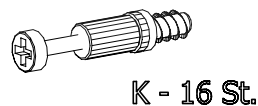
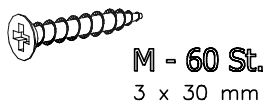
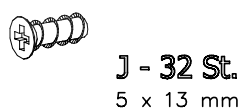
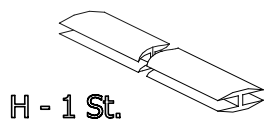

I

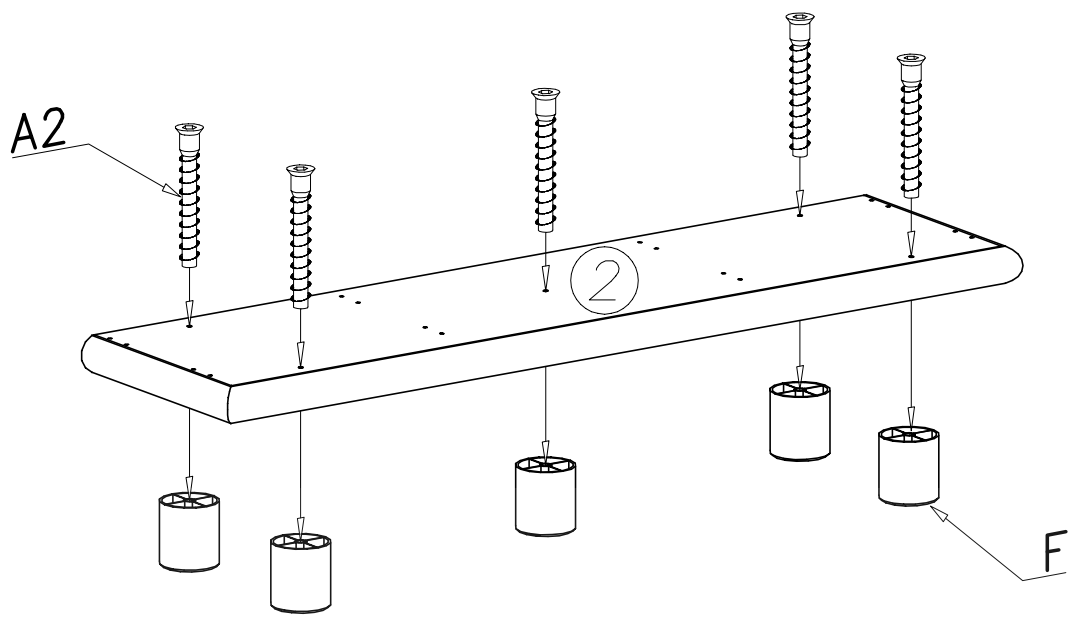

II

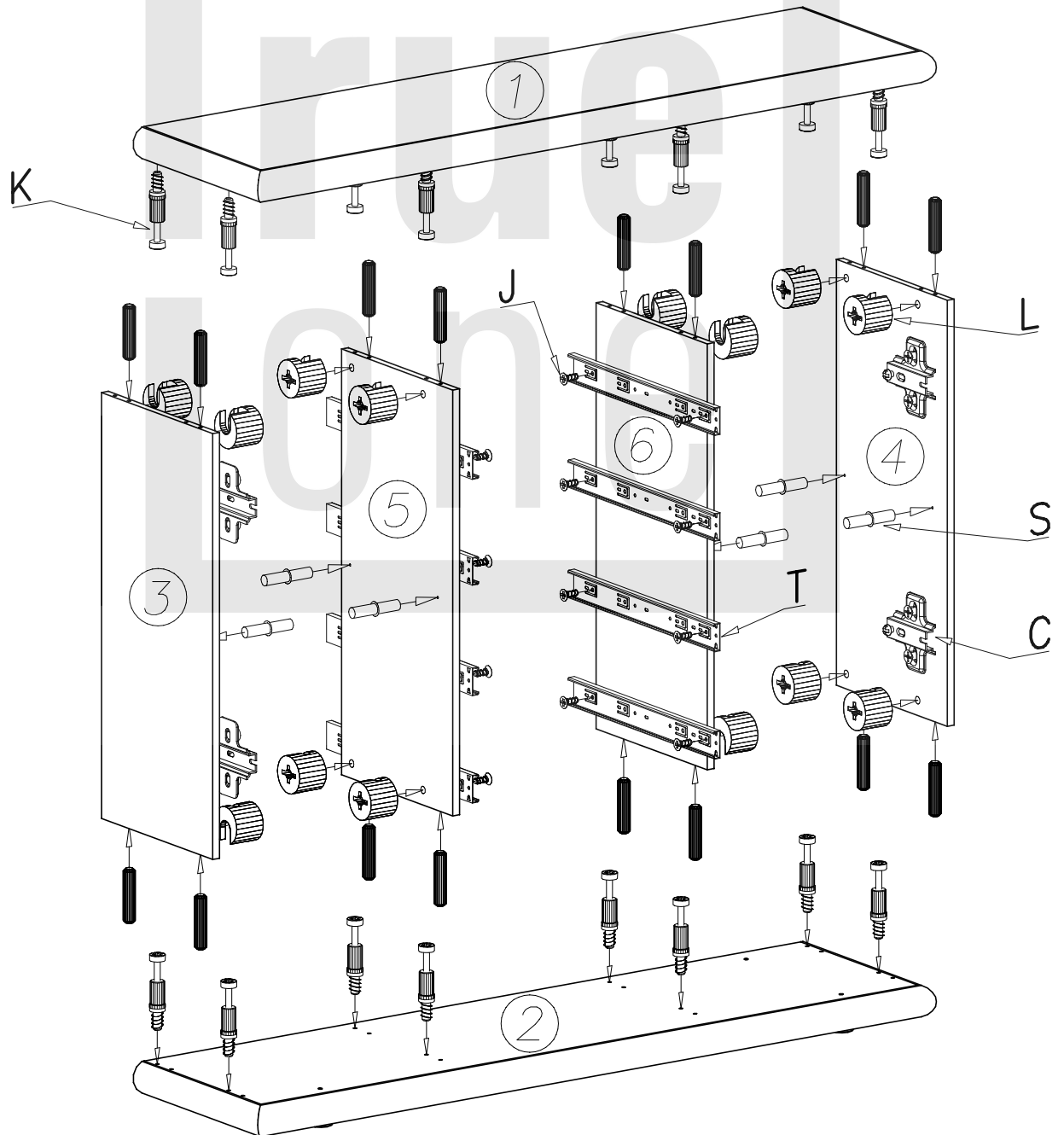

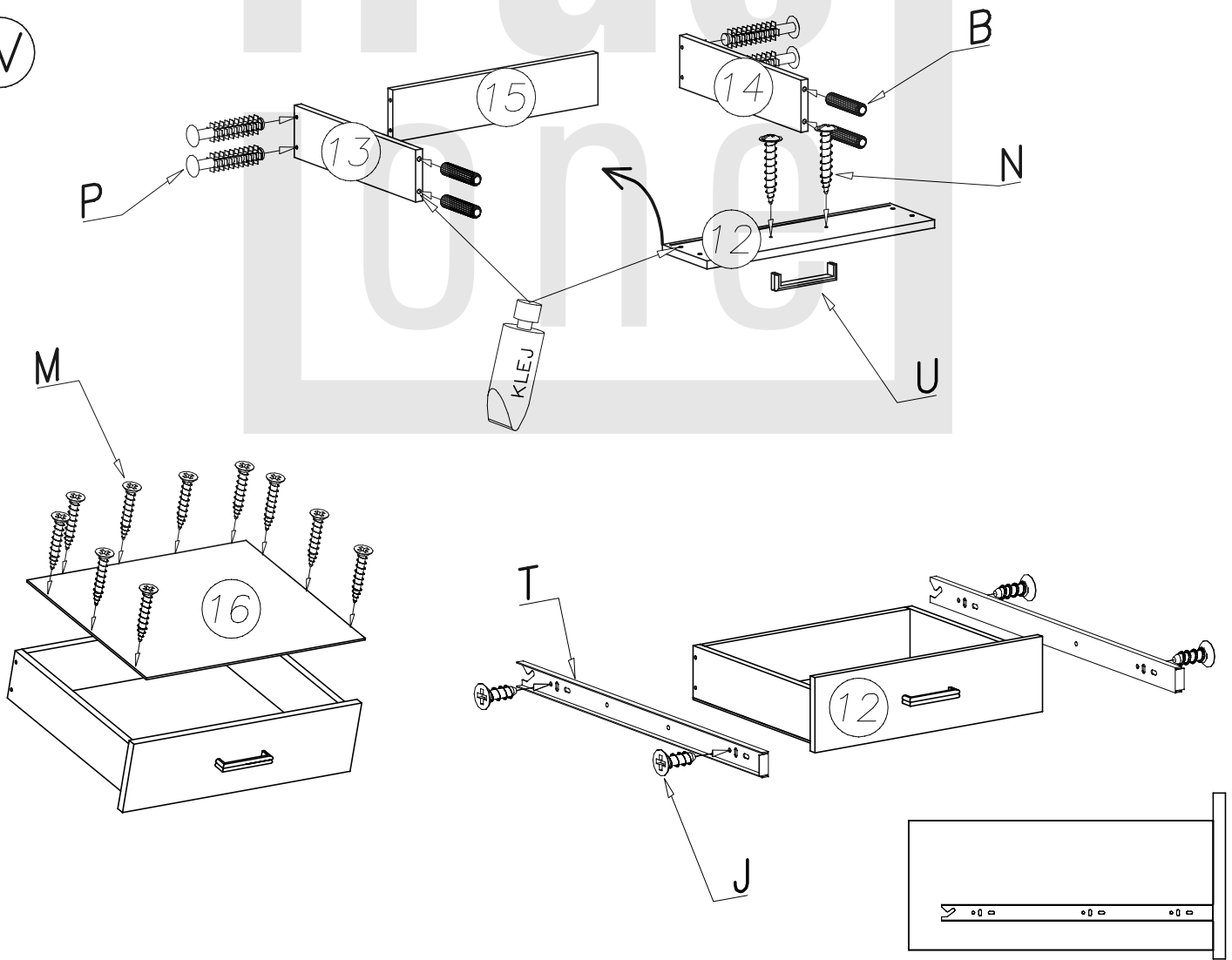
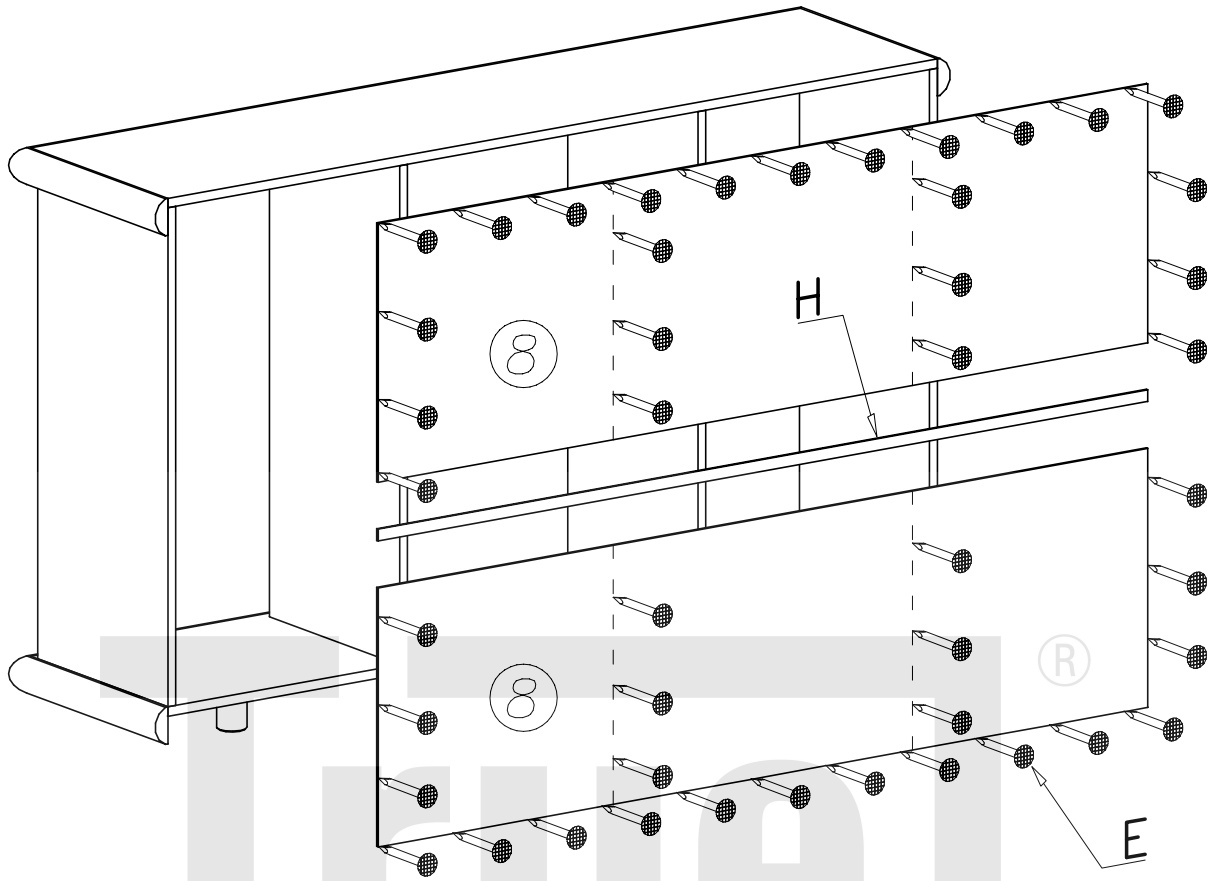

V

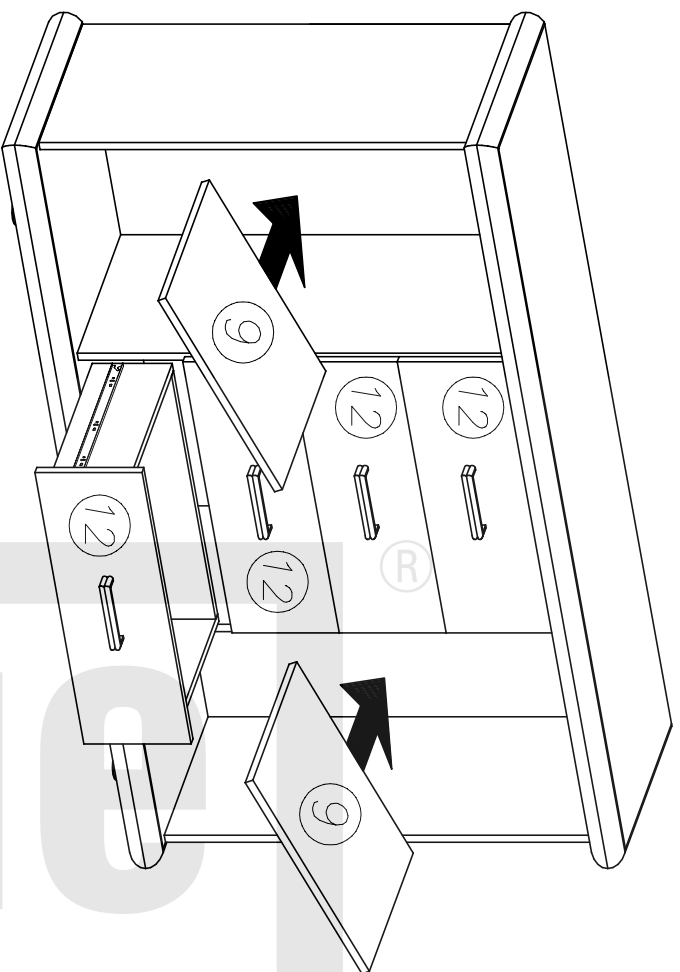

Meble zawierają elementy drewniane, których barwa i układ słoju są uzależnione od wielu czynników, dlatego mogą występować różnice w fakturze i barwie co nie stanowi wady produktu i nie wpływa na jego trwałość i funkcjonalność.

Listwy drewniane mogą ujawniać niewielkie zmiany w kształcie i wymiarach wywołane specyficznymi warunkami eksploatacji

- wilgotność, różnice temperatur etc.

VI

