

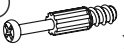























- B1**   $\phi$  8x28 x28
- T1**  x38
- M1**  x38
- C2**   $\phi$  20 x34
- W1**  x16
- W2**  x8
- J23**  x12
- F1**  x19
- P2**  3x16 x33
- G4**  x8
- L6**  x2
- Z2**  x2
- S5**  3,5x16 x8

- X9**  x7
- X19**  x2
- S8**  4x13 x14
- D4**  x7
- F10**  x5
- P17**  4x20 x5
- U35**  x1
- P2**  3x16 x2
- J11**  x1
- P13**  3,5x13 x2
-  

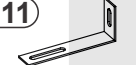
Nr	Ausmaß		St	Colli
1	596	340	5	2
2	1024	516	4	1
3	1901	75	18	1
4	1901	75	18	1
5	970	75	18	1
6	1960	382	15	1
7	1960	382	15	1
8	762	516	15	1
9	516	170	15	1
12	762	296	15	1
13	1134	296	15	1
17	1945	361	15	1
18	597	357	15	2
19	326	357	15	1
20	597	357	15	1
21	326	357	15	3
22	938	382	15	1
23	969	382	15	1
24	762	611	2	1
25	1959	340	2	1
26	611	1196	2	1

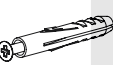

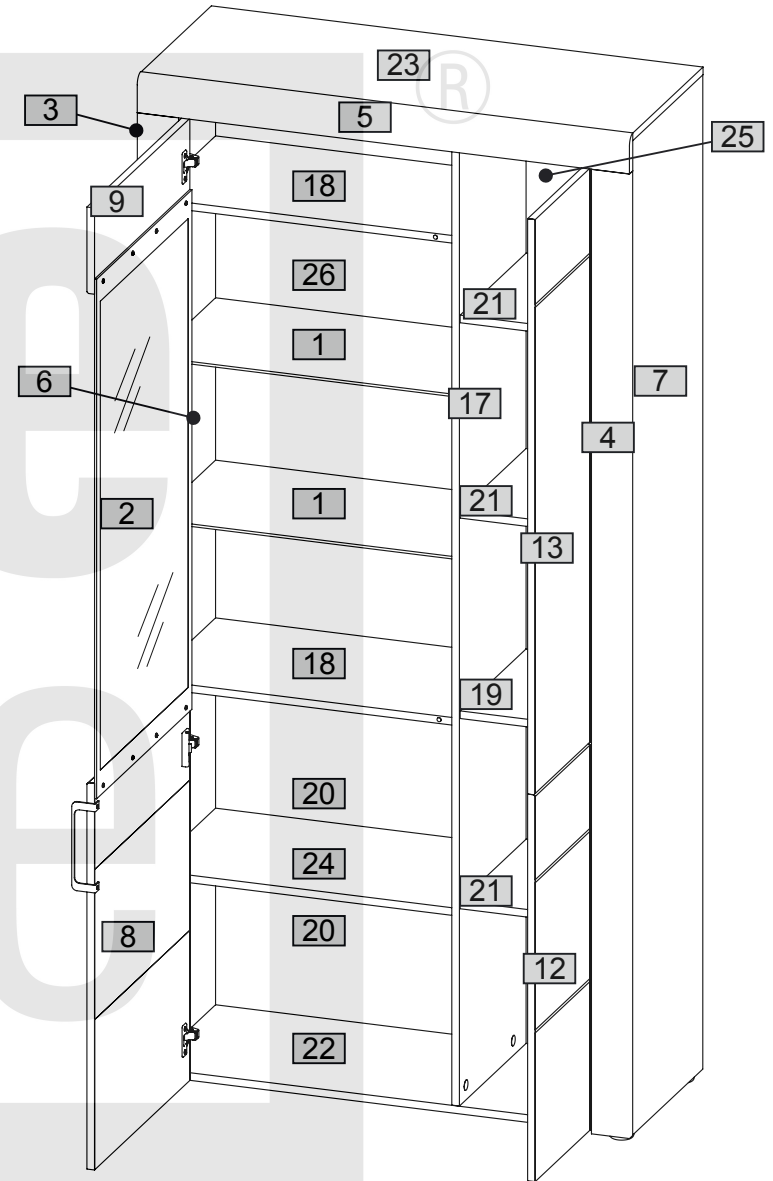
0 10 20 30 40 50 60 70 80 90 100 110 120 130 140 150 160 170 180 190 200



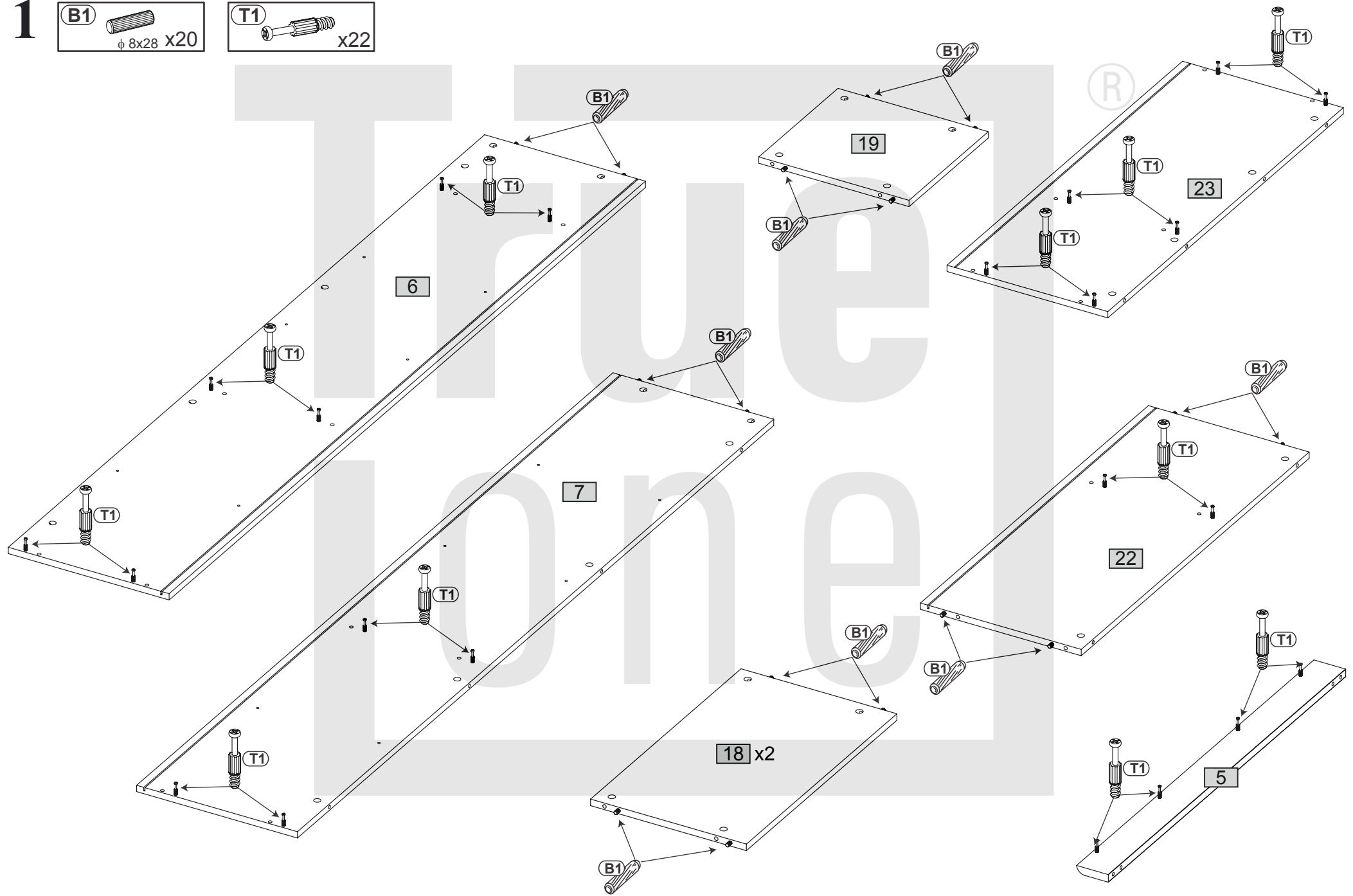
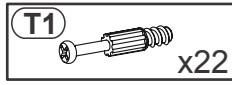
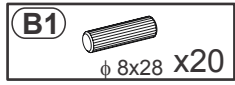

1



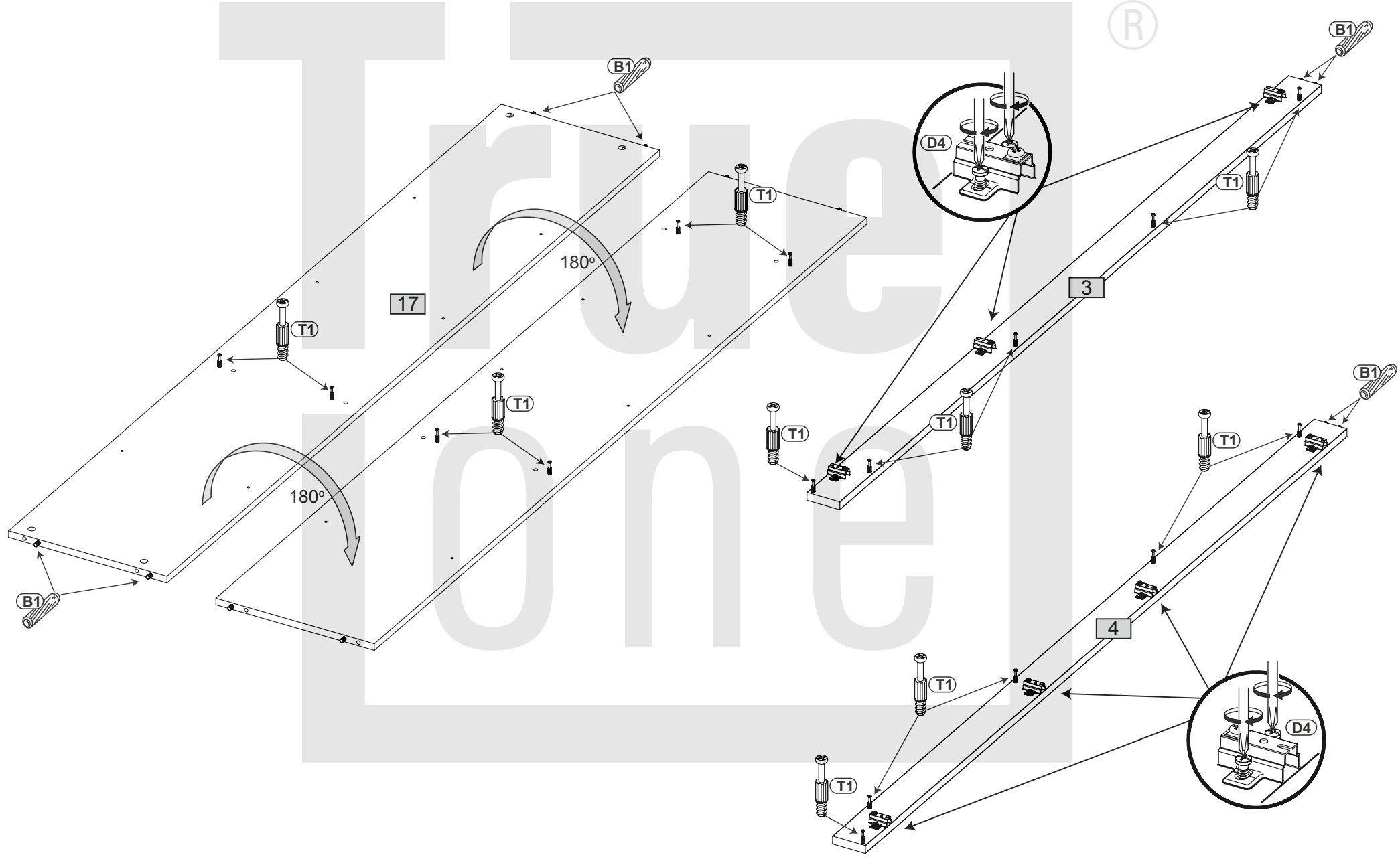
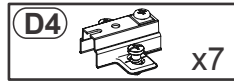
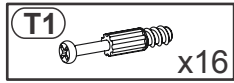
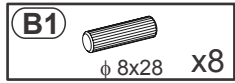

2

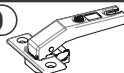

3

**X9**  x7    **S8**  4x13    x14

**G4**  x8    **P2**  3x16    x8

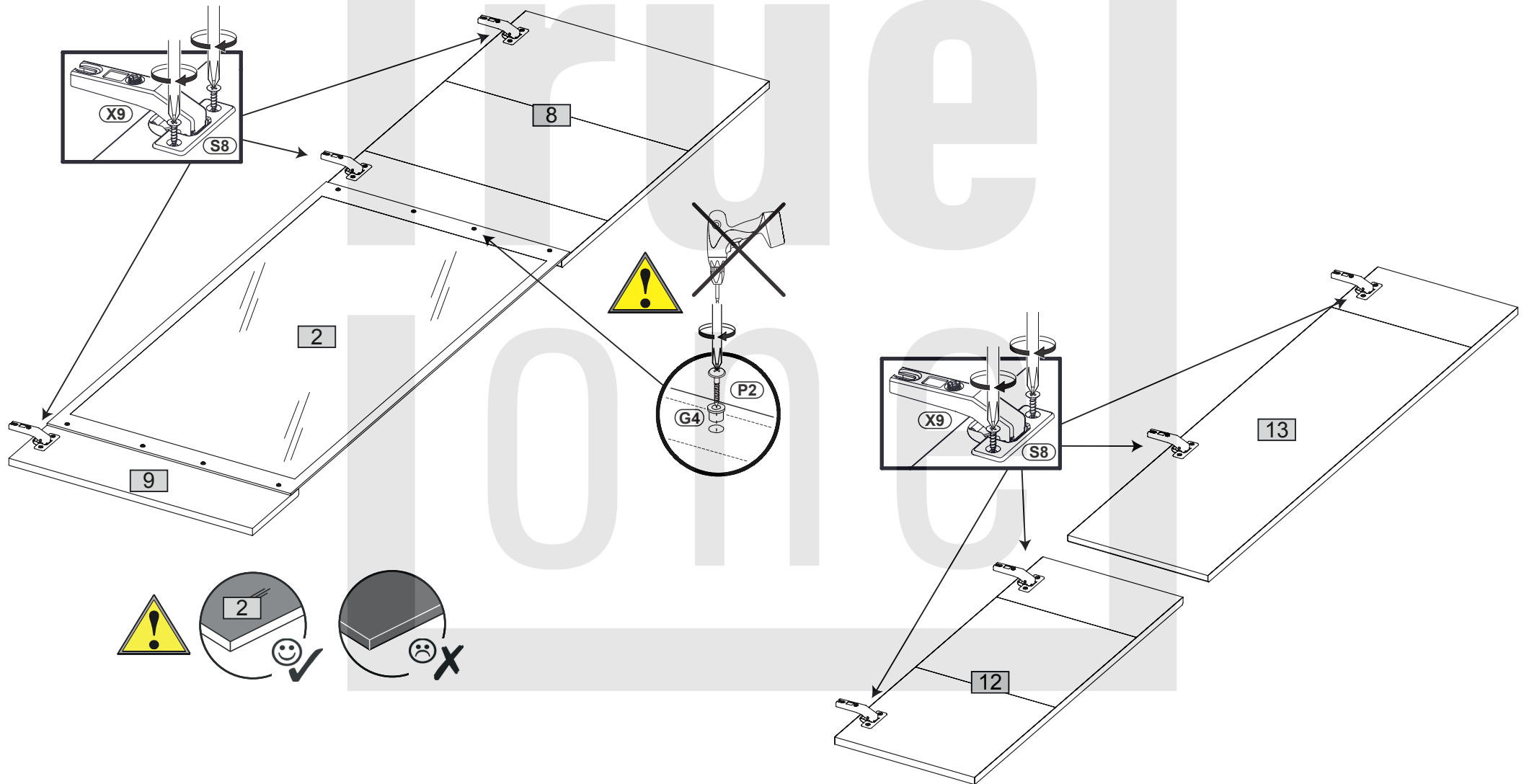

**4** **M1**  x8

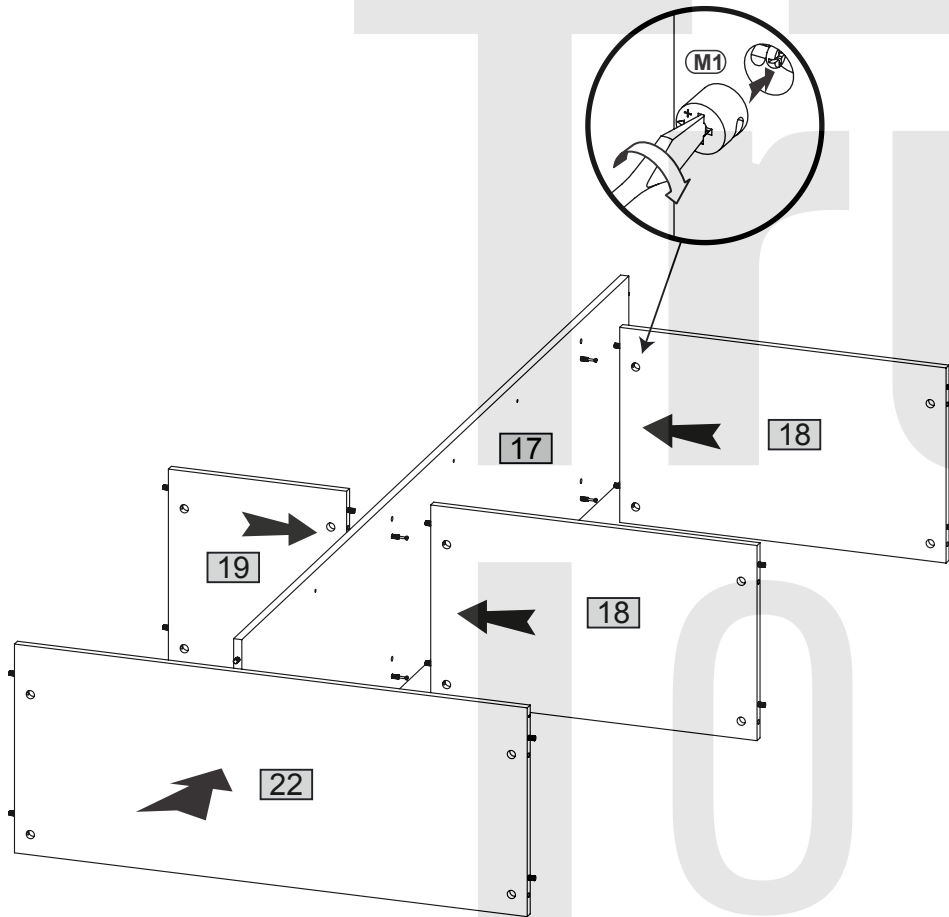

**5** **M1**  x10

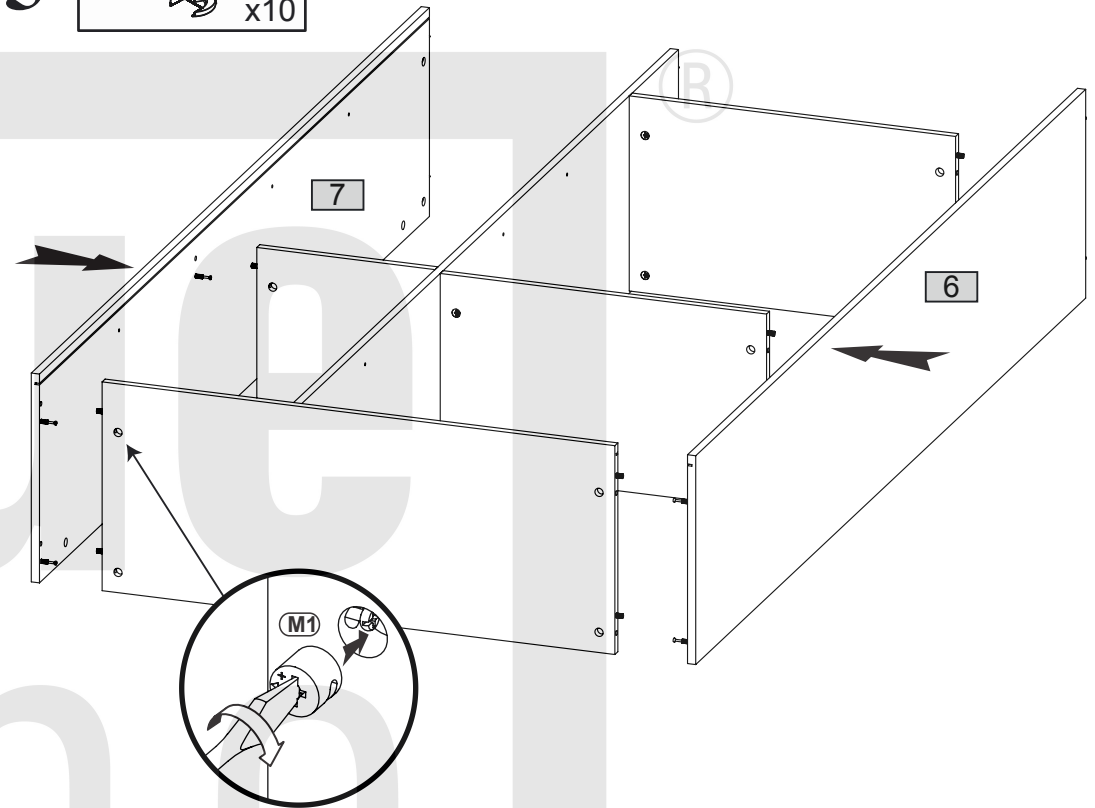

**6** **M1**  x4

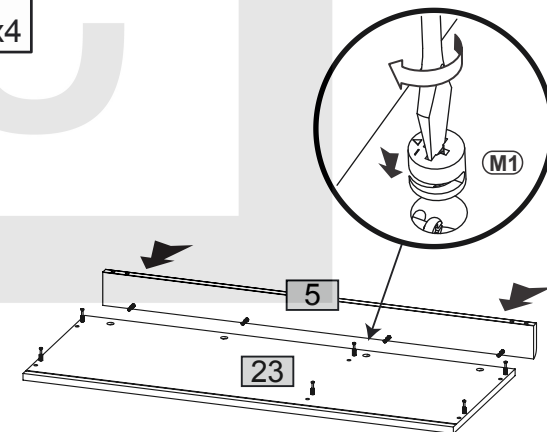

7

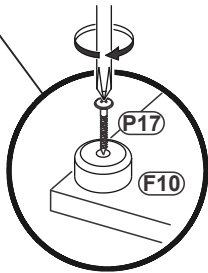
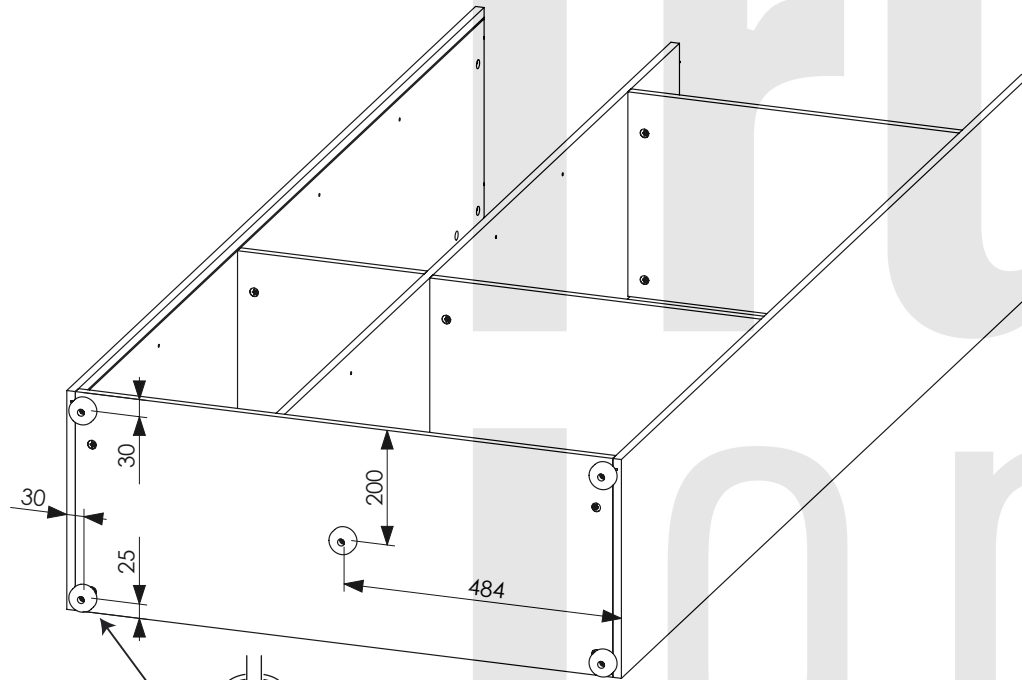
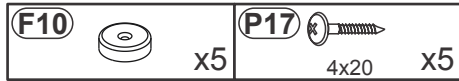

8

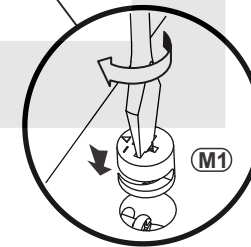
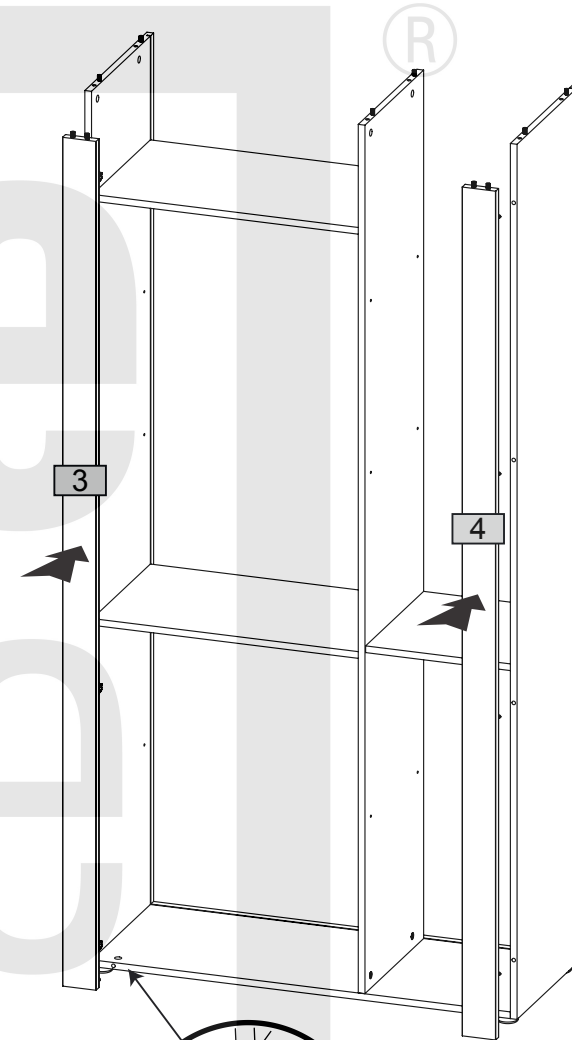

9

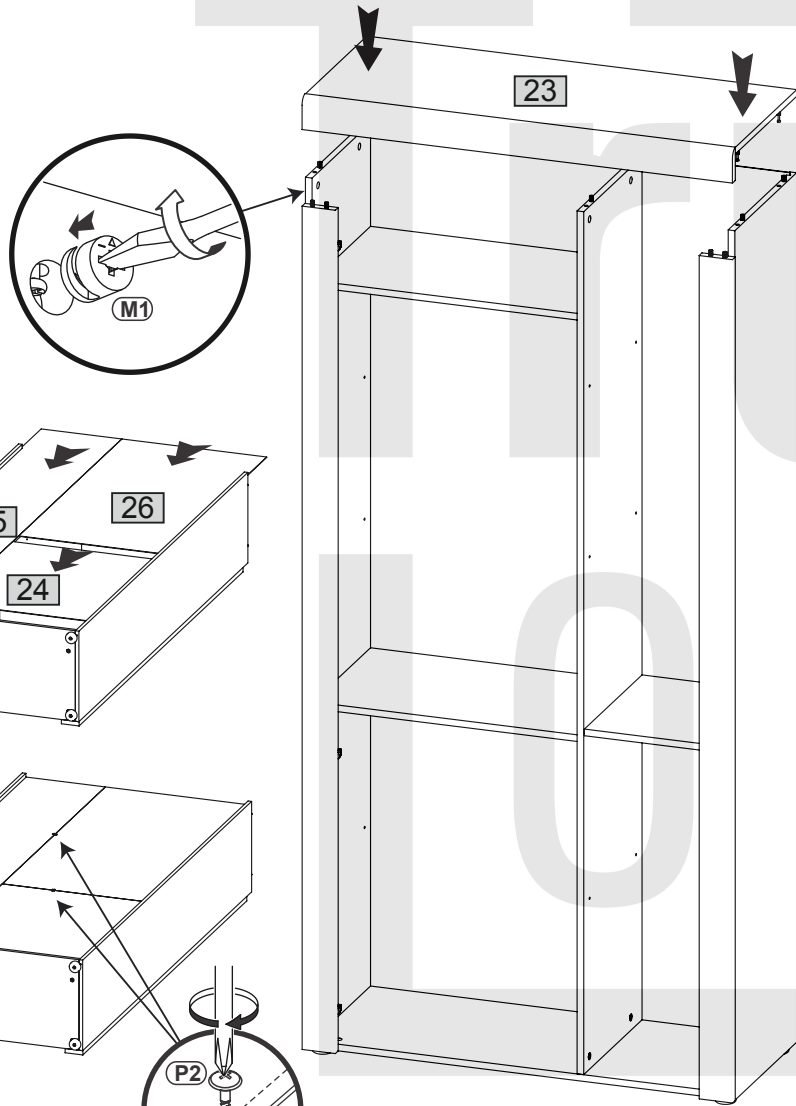
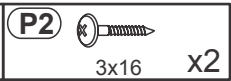

10

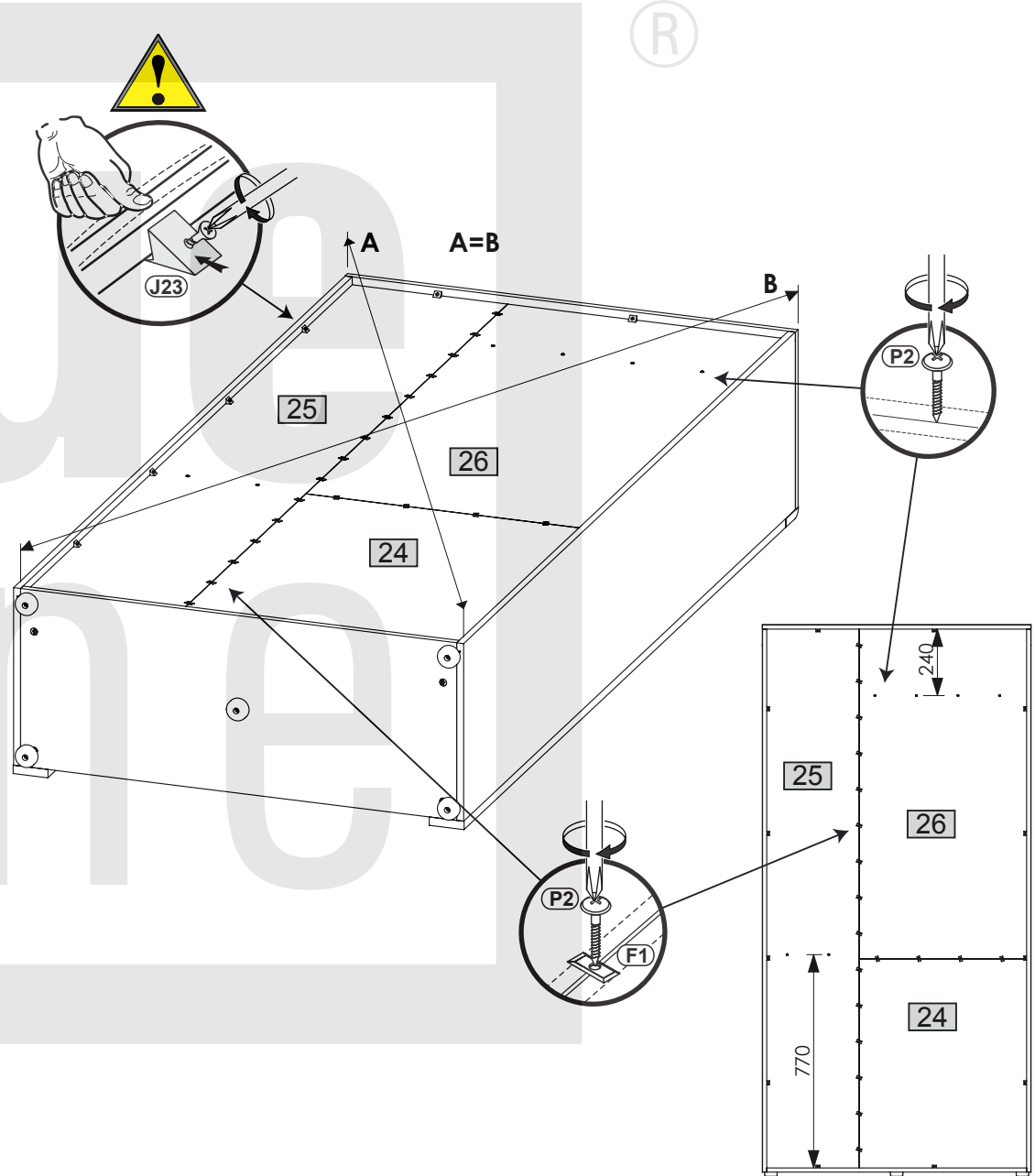
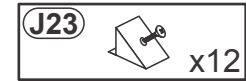
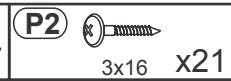



11

