

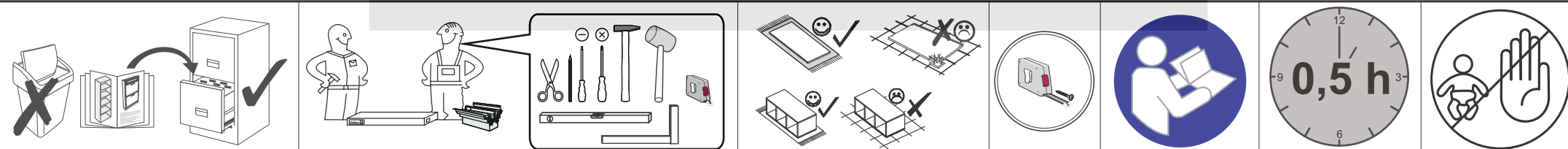

- (GB) Assembly instructions
- (DE) Montageanleitung
- (FR) Notice de montage
- (NL) Handleiding voor de montage
- (IT) Istruzioni di montaggio
- (HU) Szerelési útmutató
- (ES) Instrucciones de montaje
- (PL) Instrukcja montażu
- (CZ) Montážní návod
- (SK) Návod na montáž
- (HR) Montat'e
- (TR) Montaj talimat
- (RO) Instrucțiuni de montaj
- (RU) Инструкции по монтажу

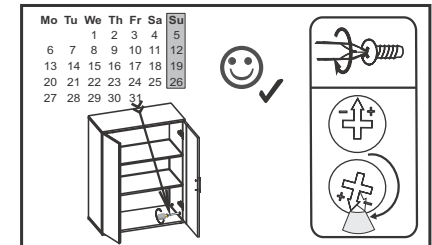
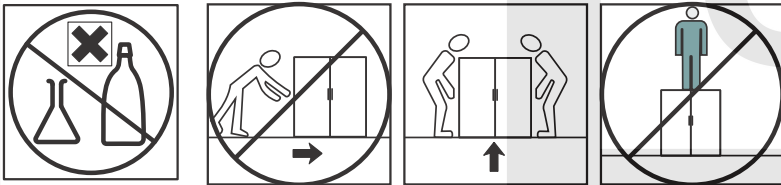
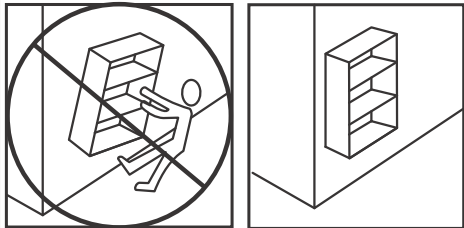

## Service • Assistenza • Dienstverlening • Serwis Servis • Szerviz • Servizio • Usluga •

Name • Nom • Nome • Naam • Nazwa  
Jméno • Názov • Név • Denumire  
Nombre • Ime • Isim

**COZY**

shop • geschäft • boutique • sklep • winkel •  
negozio • bolt • tienda • obchod • dučan • mađaza • magazin

Nr. • No. • N° • říeříd • Ć • Sz • Ne

Typ • Type • Tip • Típus • Tipo

**12**

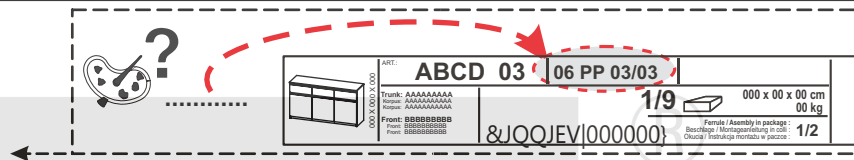
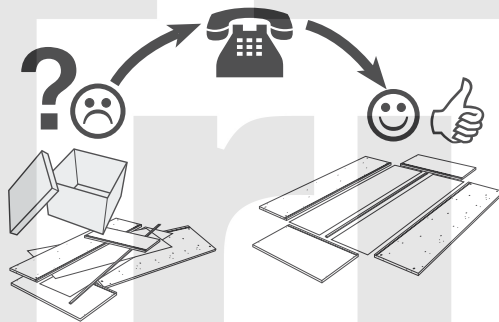
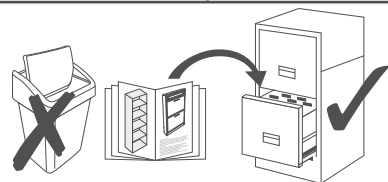

<b>M1</b>  X...	<b>W10</b>  X...
<b>T1</b>  X...	<b>K5</b>  X...
<b>B1</b>  fi 8x28 X...	<b>G5</b>  X...
<b>Z25</b>  fi 35 KR0 X...	<b>S4</b>  3x16 X...
<b>Z25s</b>  fi 35 KR0 X...	<b>F10</b>  X...
<b>S9</b>  4x16 X...	<b>G1</b>  X...
<b>D22</b>  H0 X...	<b>P10</b>  3x13 X...
<b>S10</b>  3,5x25 X...	

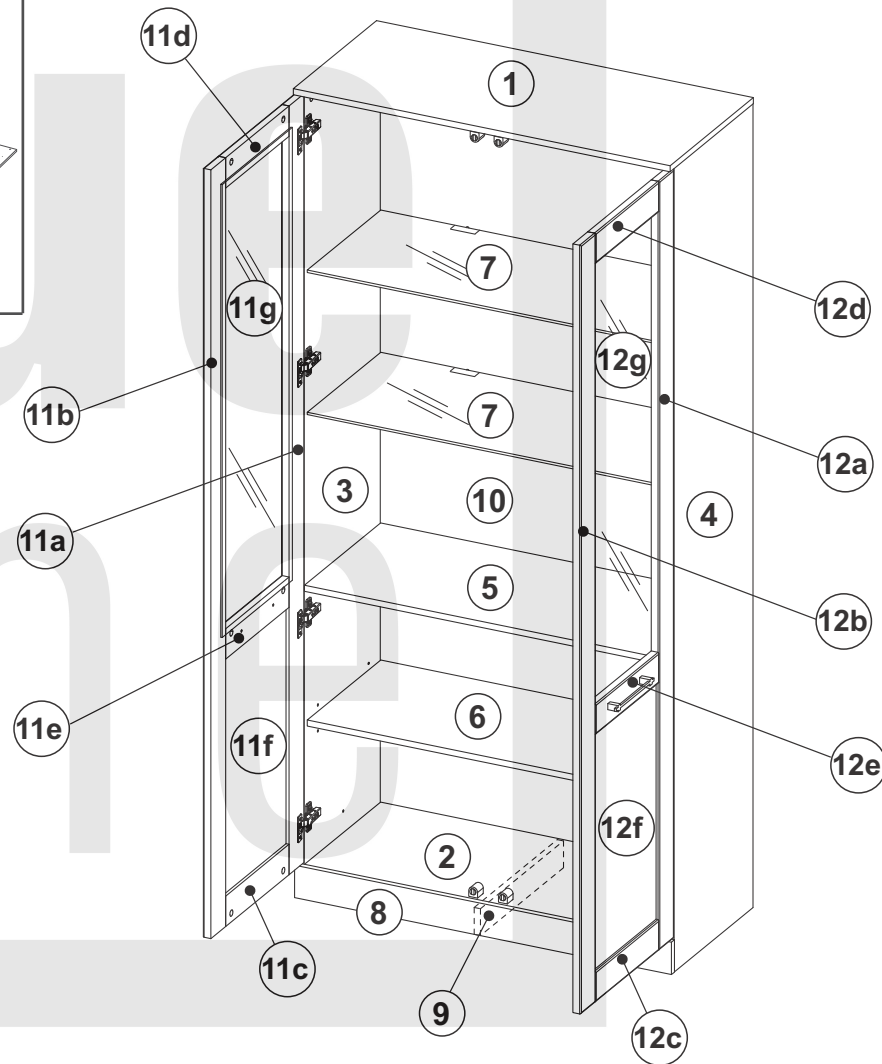

max.





max.



0 10 20 30 40 50 60 70 80 90 100 110 120 130 140 150 160 170 180 190 200

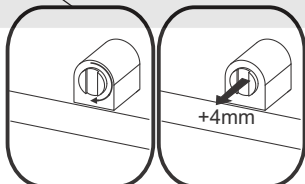
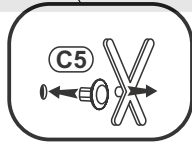
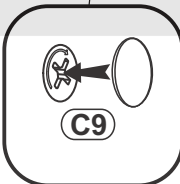
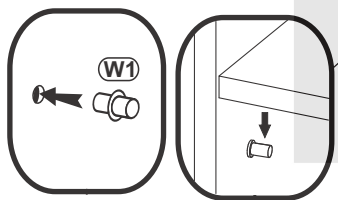
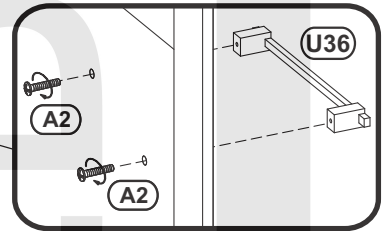
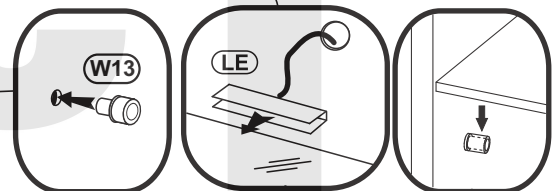
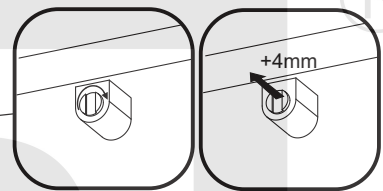
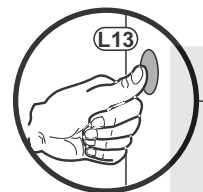
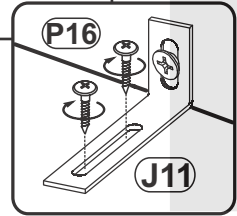
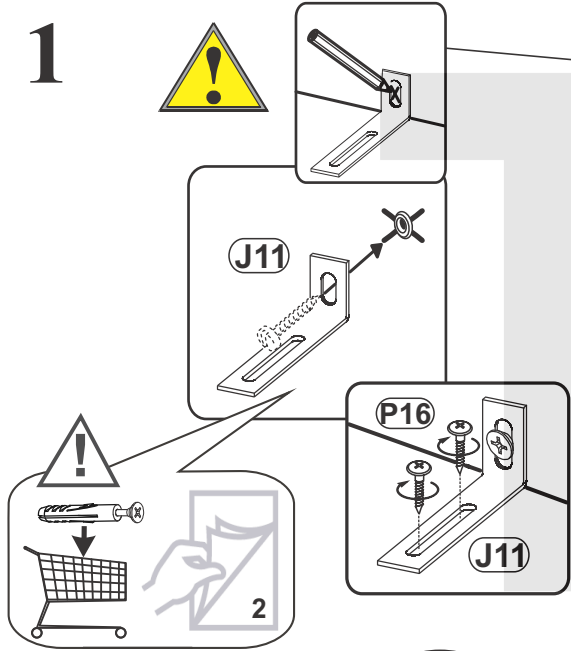
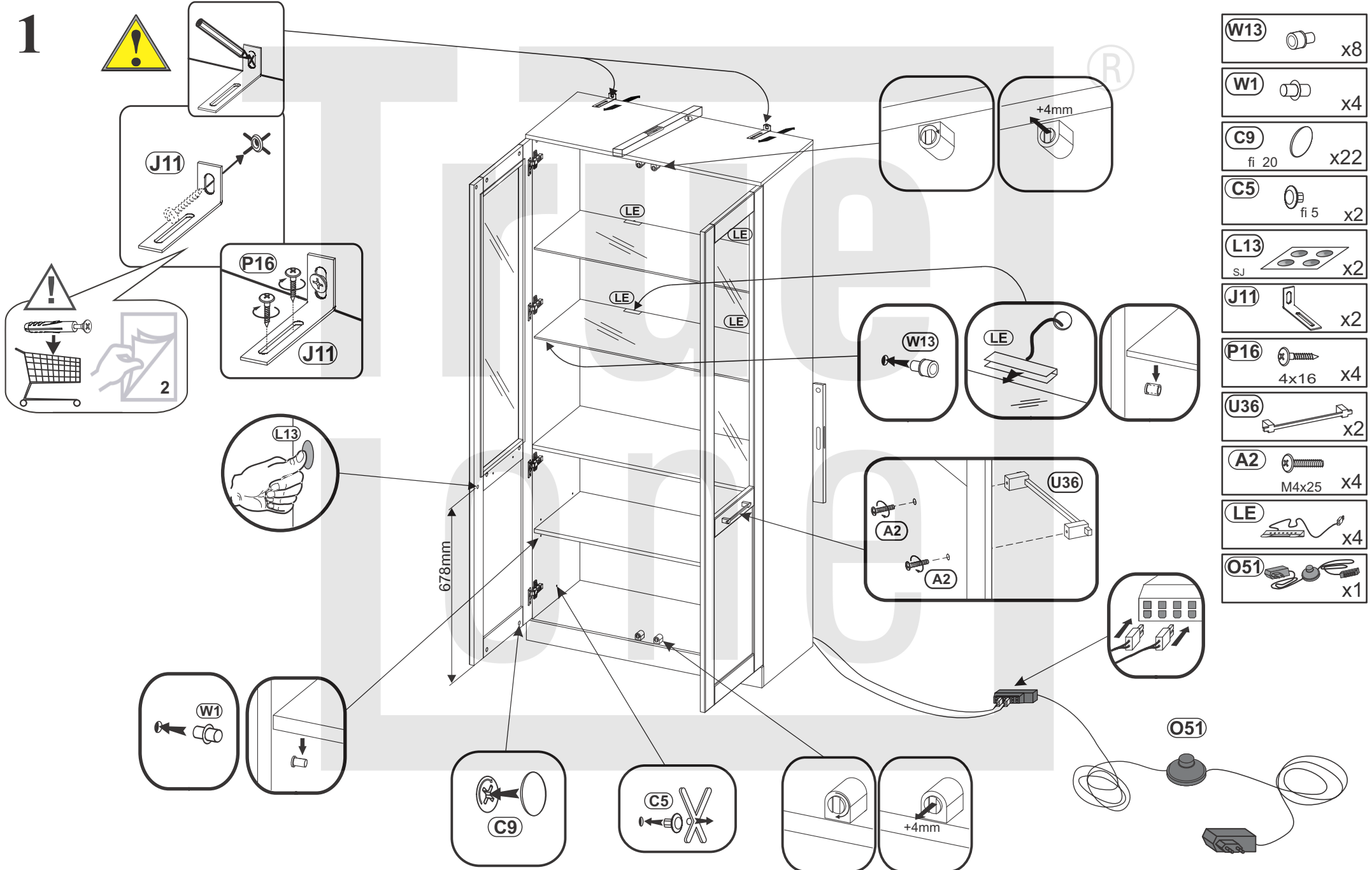





**W13**  x8

**W1**  x4

**C9**  fi 20 x22

**C5**  fi 5 x2

**L13**  SJ x2

**J11**  x2

**P16**  4x16 x4

**U36**  x2

**A2**  M4x25 x4

**LE**  x4

**O51**  x1

