

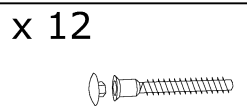

MAMBA - SZAFKA

→ 90 + 203 \ 55

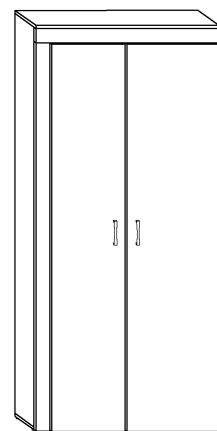

(a)

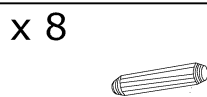

(b)

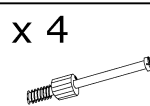

(c)

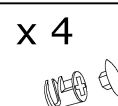

(d)

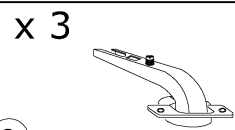

(e)

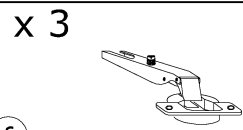

(f)

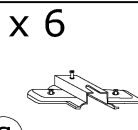

(g)

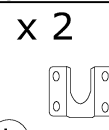

(h)

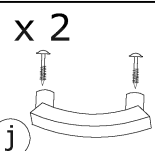

(j)

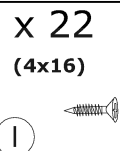

(l)

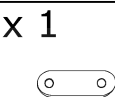

(m)

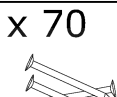

(n)

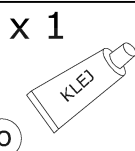

(o)

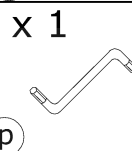

(p)

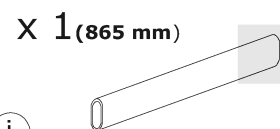
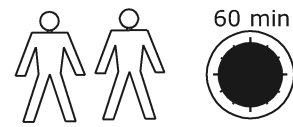

(i)

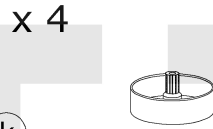

(k)



1 - FAZY MONTAŻU

A - OZNACZENIE ELEMENTÓW

a - OZNACZENIE AKCESORIÓW

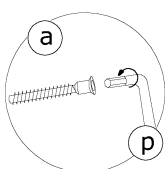
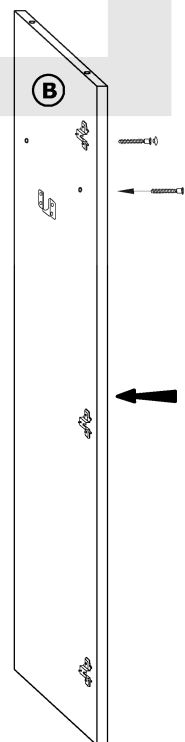
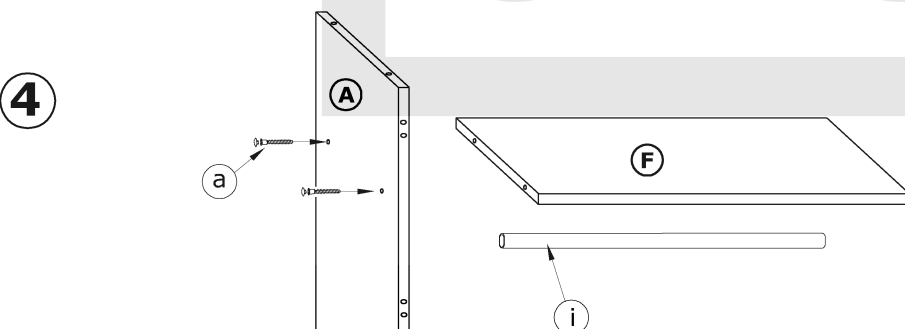
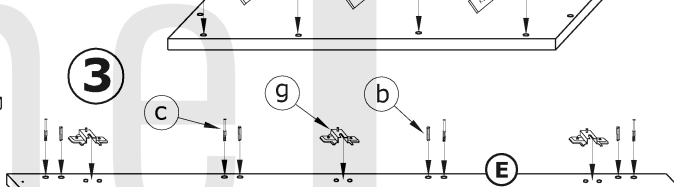
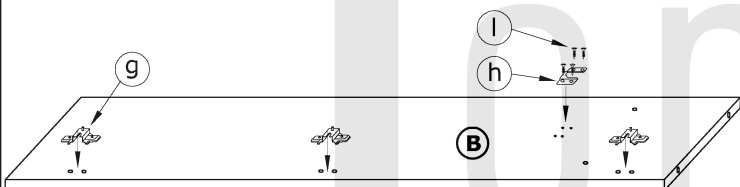
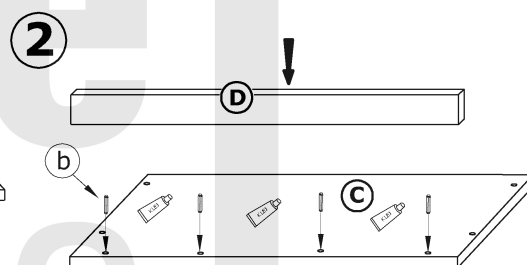
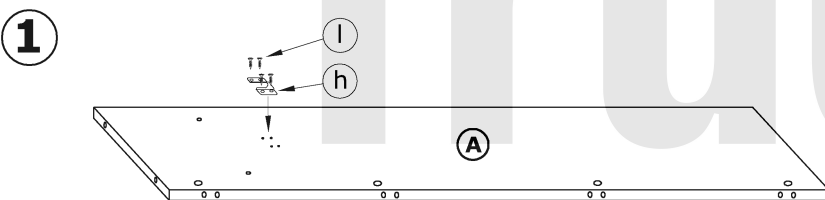

5

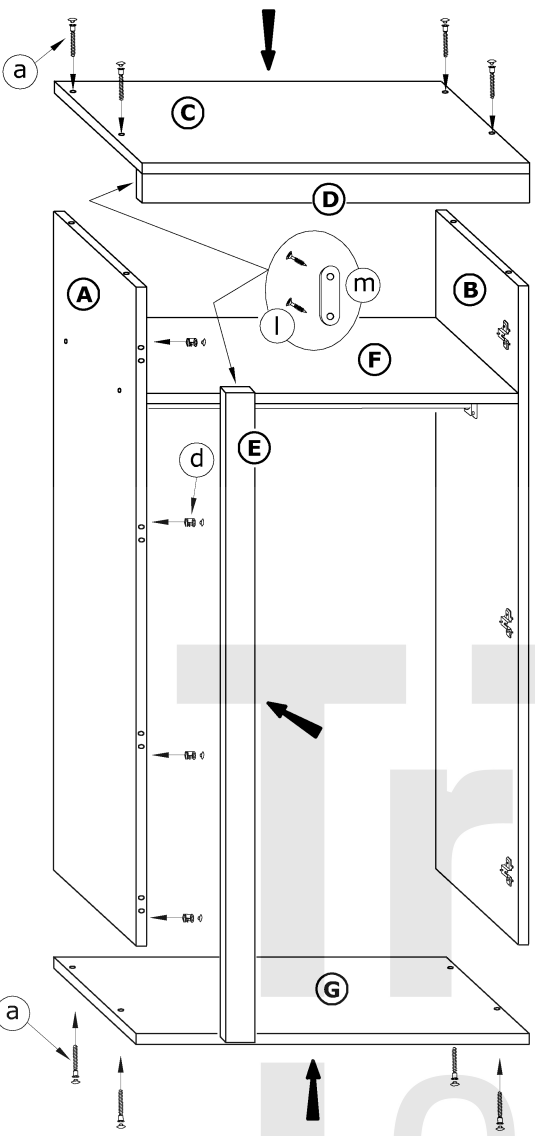

6

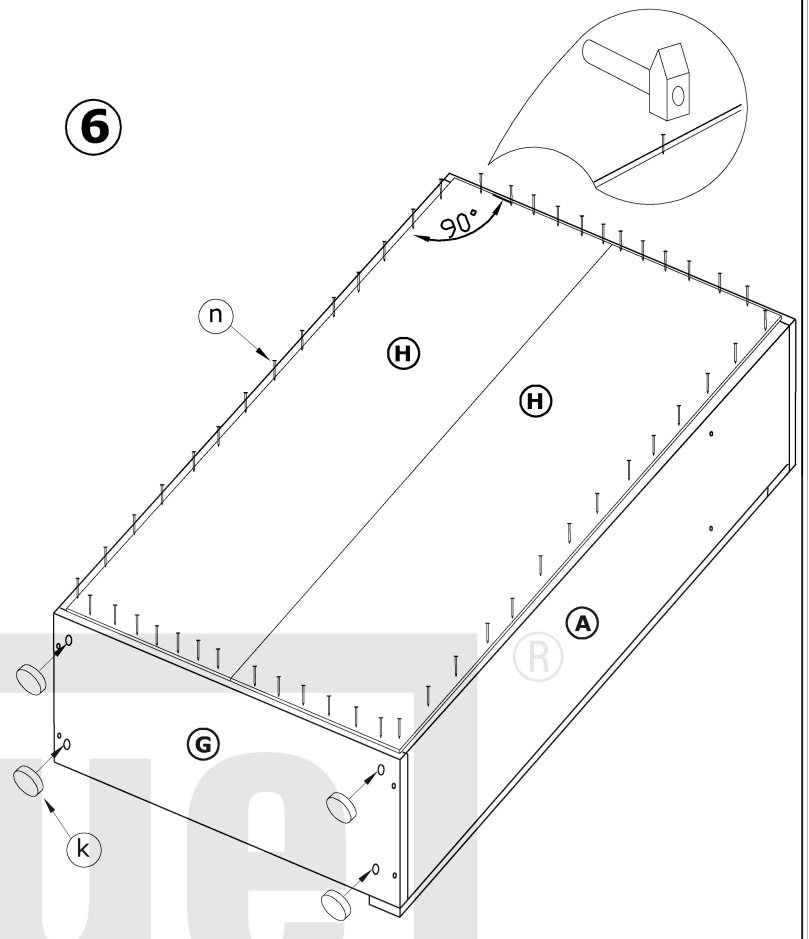

7

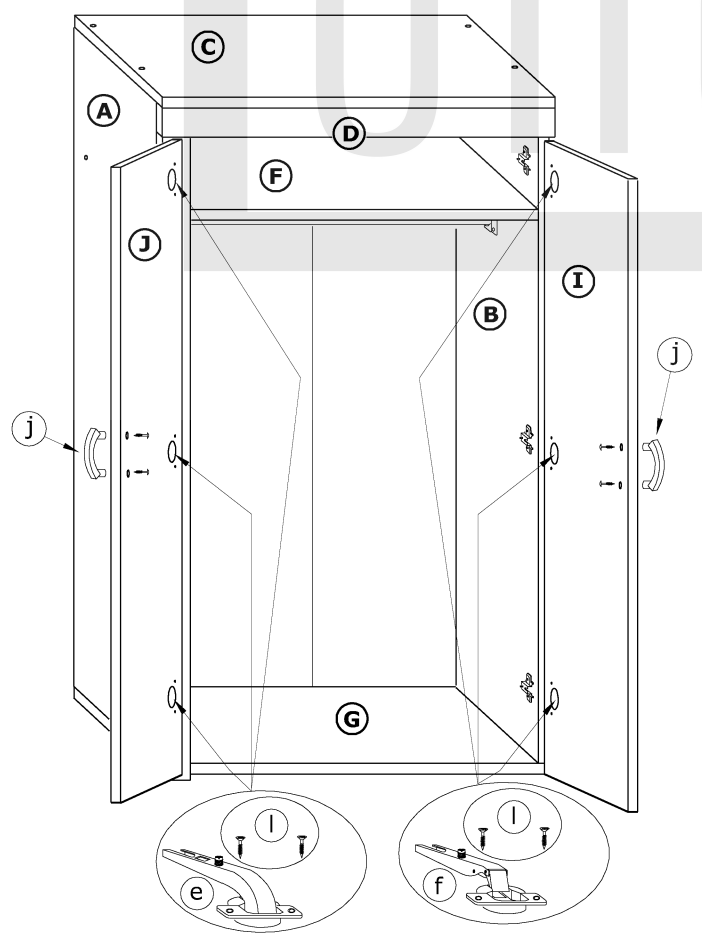

8

