

INDIANAPOLIS 1-2

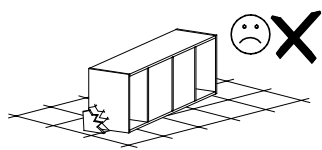

Narzędzia potrzebne do montażu

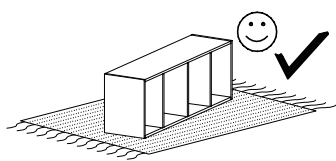
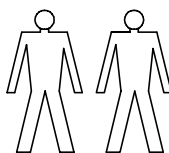
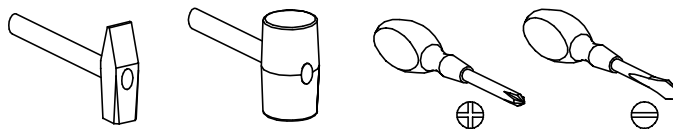

UWAGA !!

MONTOWANIE USZKODZONYCH
ELEMENTÓW POWODUJE UTRATĘ
GWARANCJI

nr	D[mm]	S[mm]	G[mm]	Ilość
1	527	563	16	2
2	563	176	16	1
3	563	176	16	1
4	1870	563	16	1
5	1870	80	16	1
6	1870	563	16	1
7	1870	80	16	1
8	527	80	16	1
9	560	580	48	1
10	1800	550	2,5	1
11	1583	395	16	1
12	395	190	16	1
13	500	150	16	1
14	500	150	16	1
15	340	150	16	1
16	505	370	2,5	1

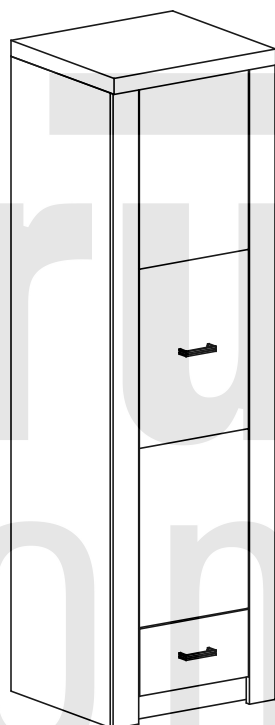

W przypadku reklamacji proszę o podanie numeru pakowacza znajdującego się na kartonie



S - 6 St.

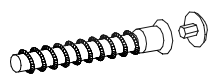

A - 8 St.

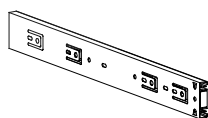

T - 1 Kpl.

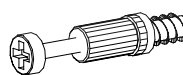

K - 14 St.



M - 18 St.
3 x 30 mm

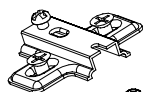

C - 3 St.

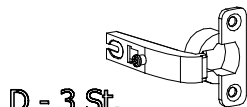

D - 3 St.



R - 1 St.
520 mm

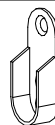

Y - 2 St.



J - 8 St.
5 x 13 mm

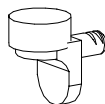

F - 1 St.



Z - 1 St.



U - 2 St.

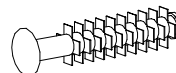

P - 4 St.

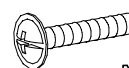

N - 4 St.
M4 x 25 mm



E - 30 St.



B - 34 St.



G - 10 St.
3,5 x 16 mm

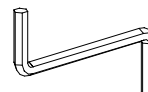

Z - 1 St.



L - 14 St.

1

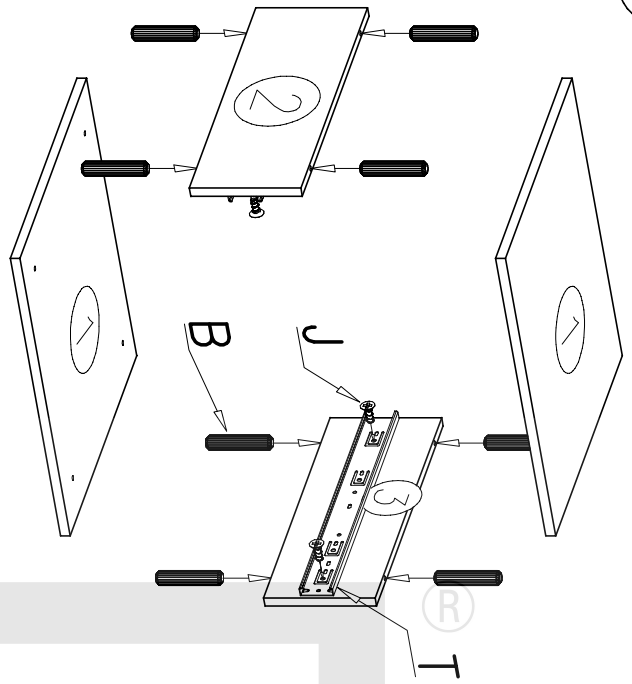
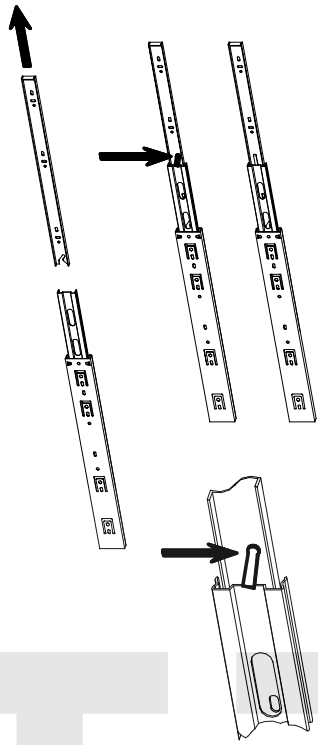
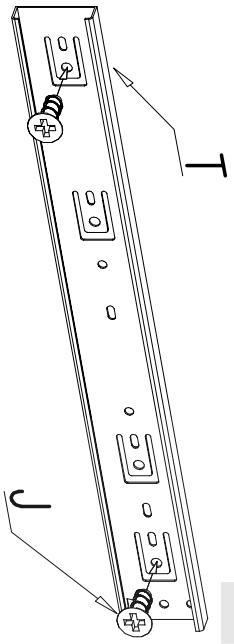

II

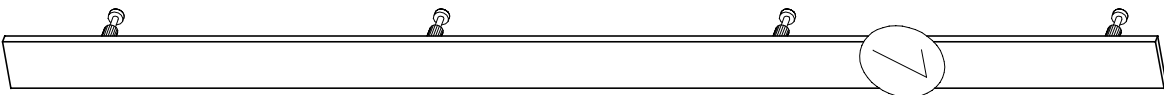
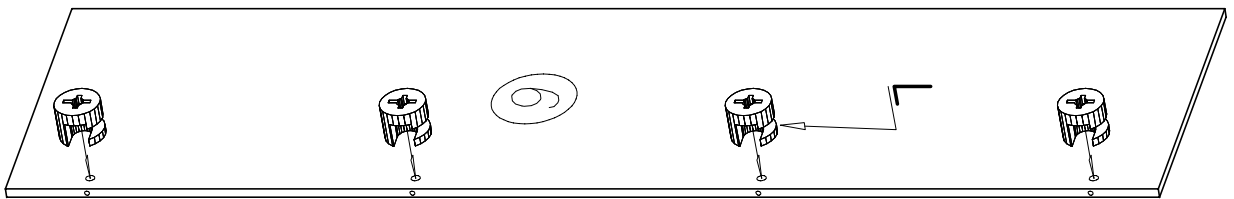
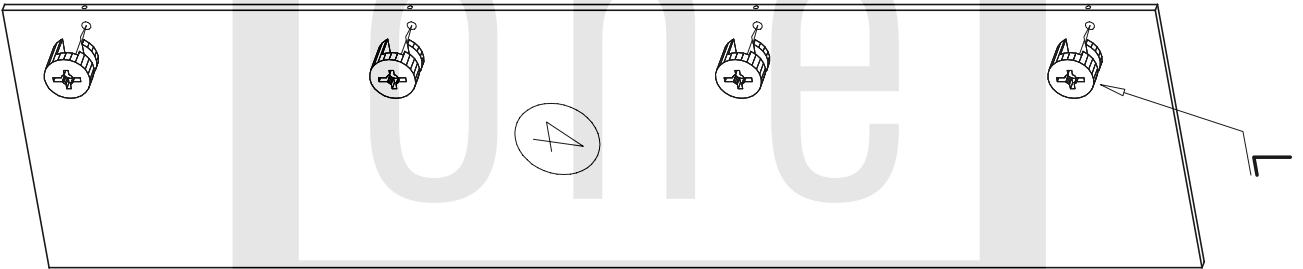
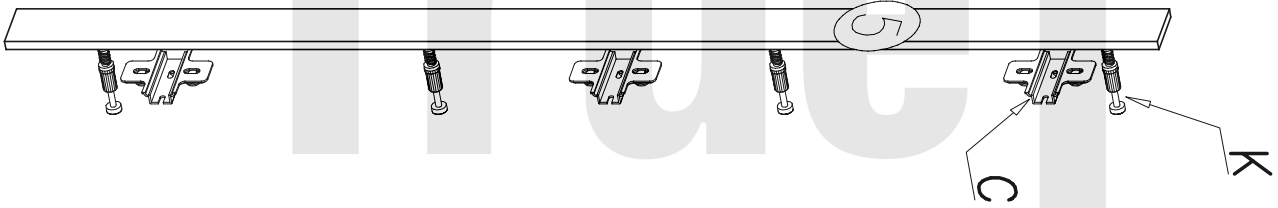

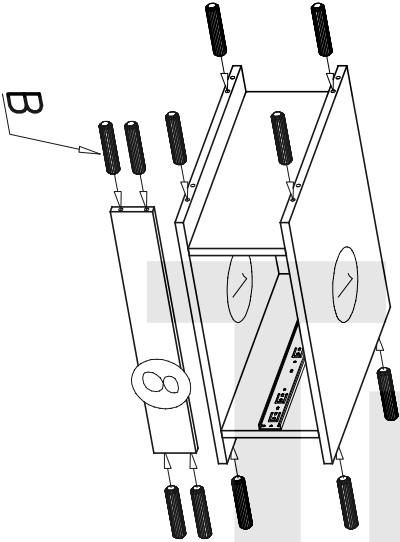
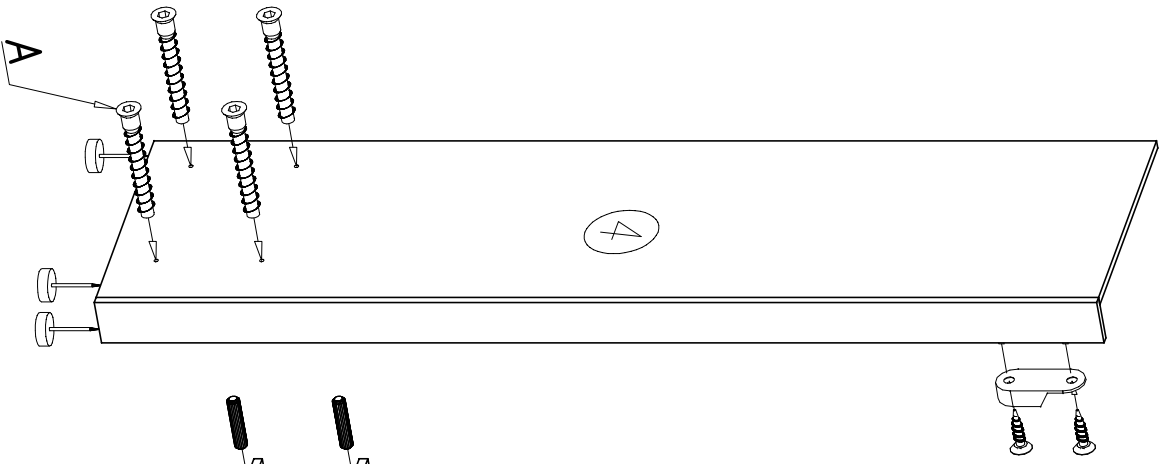

®

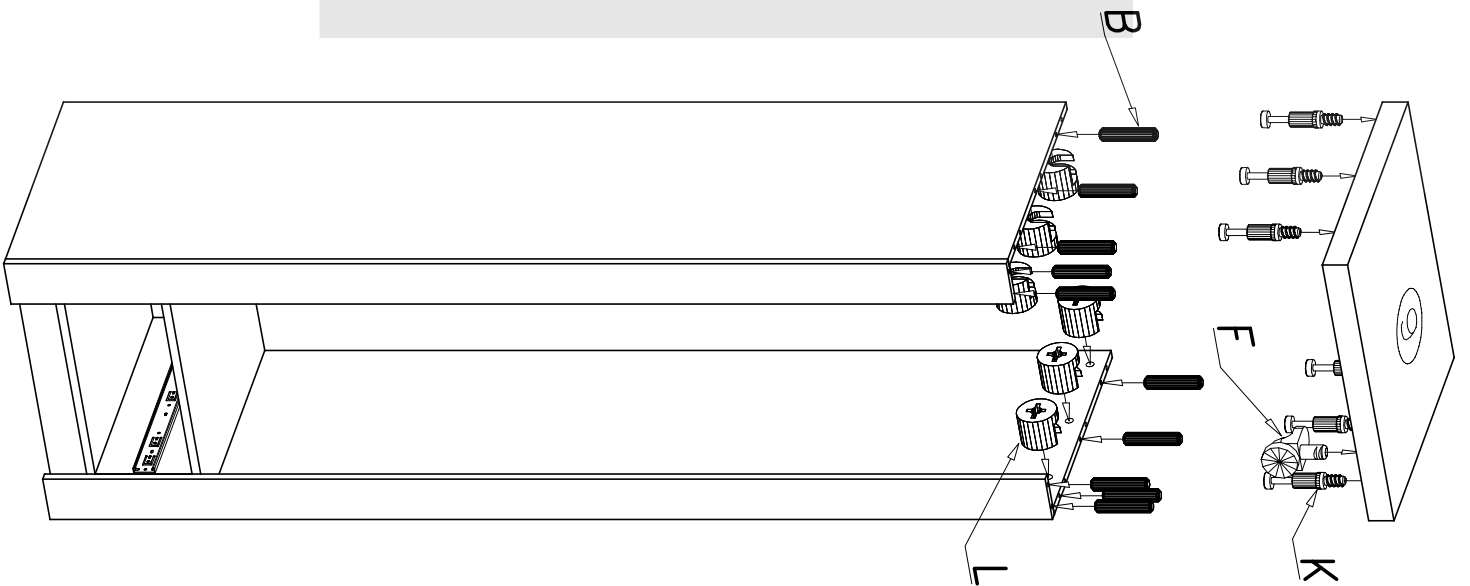
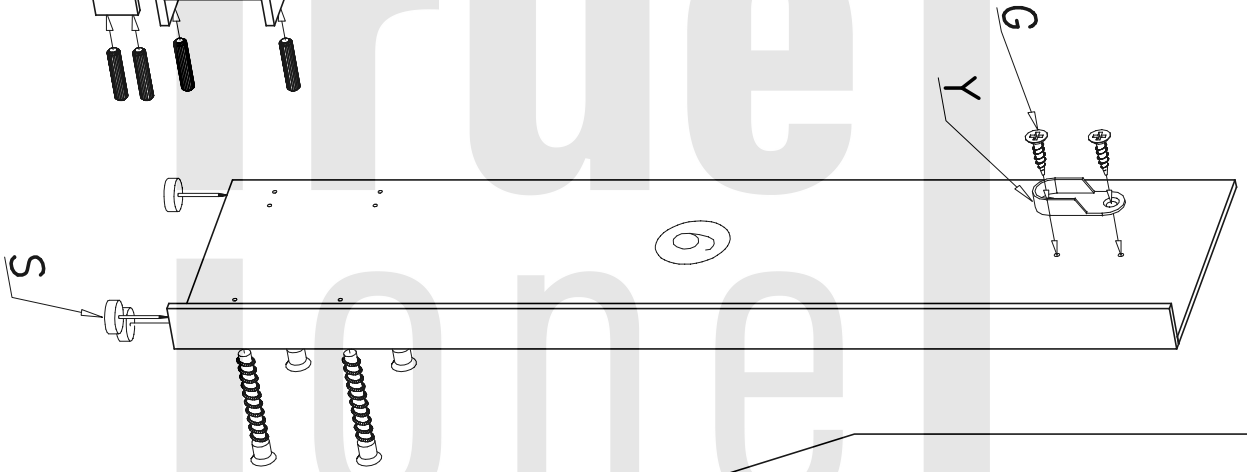

V

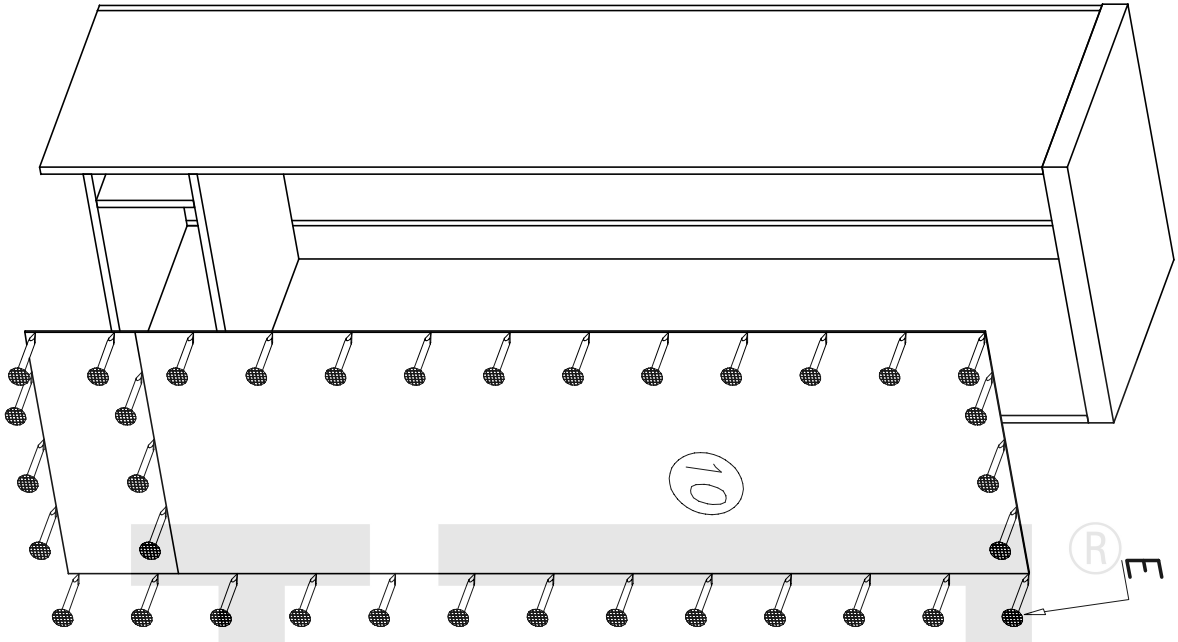

VI

