

# INDIANAPOLIS I-1

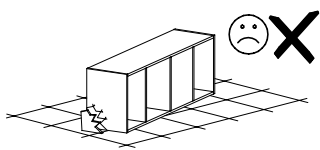

Narzędzia potrzebne do montażu

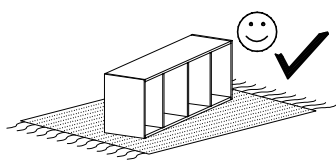
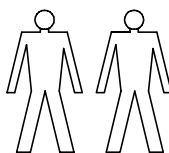
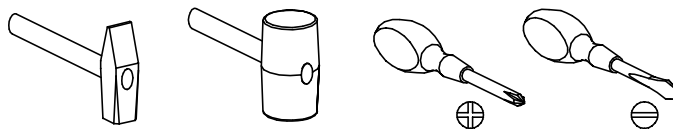

## UWAGA !!

MONTOWANIE USZKODZONYCH  
ELEMENTÓW POWODUJE UTRATĘ  
GWARANCJI

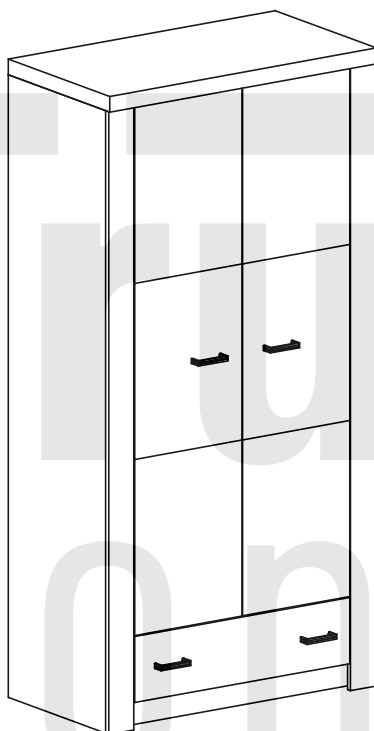

nr	D[mm]	S[mm]	G[mm]	Ilość
1	927	563	16	2
2	563	176	16	1
3	563	176	16	1
4	1870	563	16	1
5	1870	80	16	1
6	1870	563	16	1
7	1870	80	16	1
8	927	80	16	1
9	960	580	48	1
10	1800	475	2,5	2
11	1583	393	16	2
12	793	190	16	1
13	500	150	16	1
14	500	150	16	1
15	740	150	16	1
16	770	505	2,5	1
17	927	80	16	1

W przypadku reklamacji proszę o podanie numeru pakowacza znajdującego się na kartonie

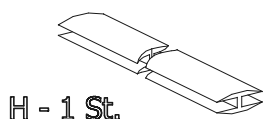

H - 1 St.



S - 7 St.



A - 12 St.

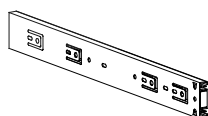

T - 1 Kpl.

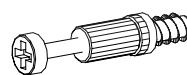
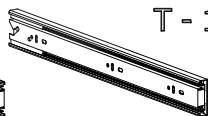

K - 14 St.



M - 25 St.  
3 x 30 mm

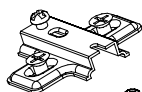

C - 6 St.

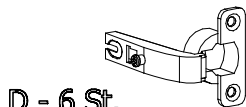

D - 6 St.

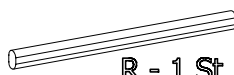

R - 1 St.  
920 mm

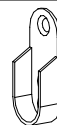

Y - 2 St.



J - 8 St.  
5 x 13 mm

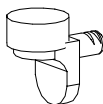

F - 2 St.



Z - 1 St.



U - 4 St.

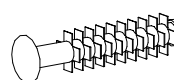

P - 4 St.

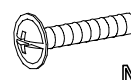

N - 8 St.  
M4 x 25 mm



E - 50 St.

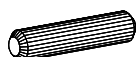

B - 34 St.



G - 22 St.  
3,5 x 16 mm

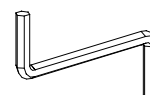

Z - 1 St.



L - 14 St.

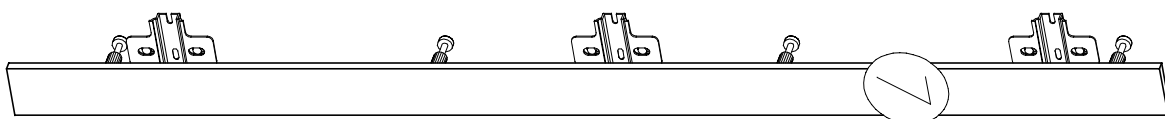
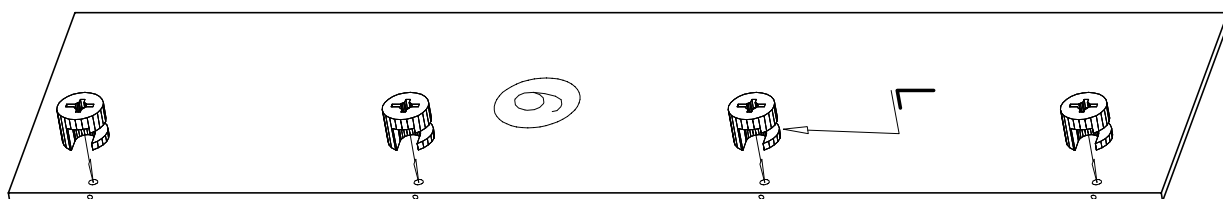
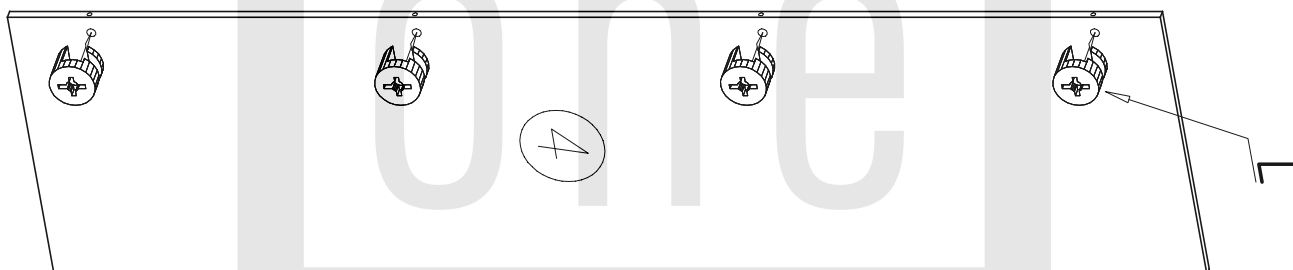
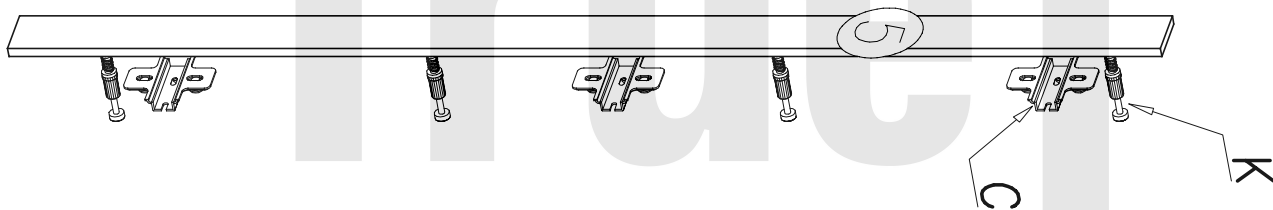
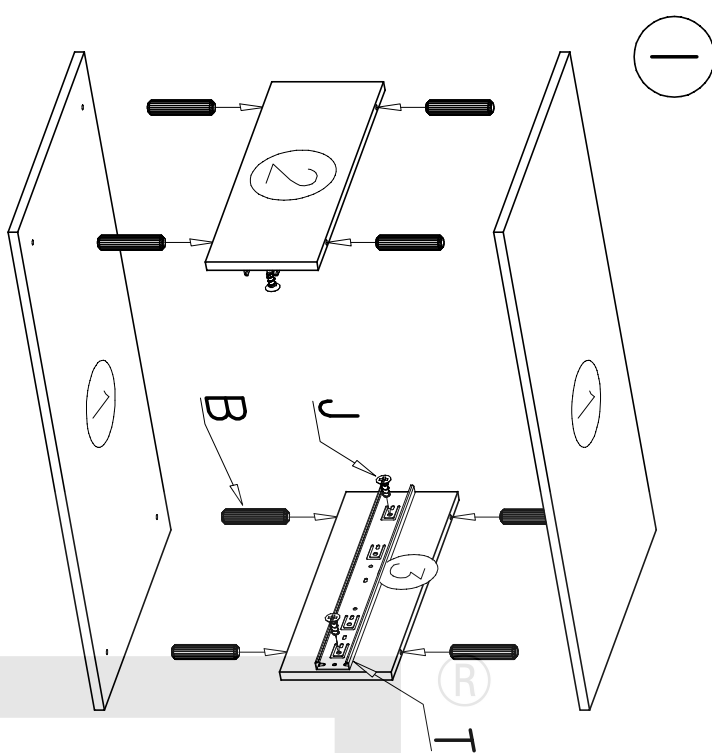
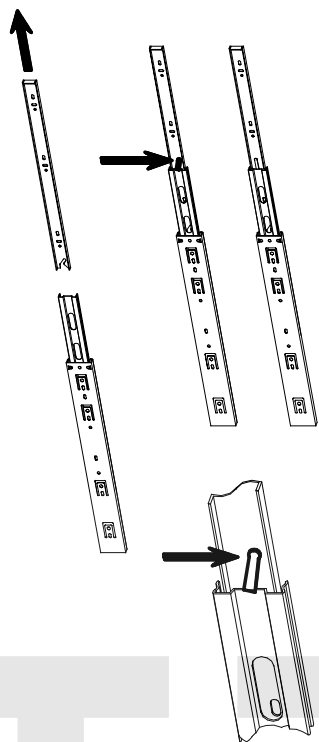
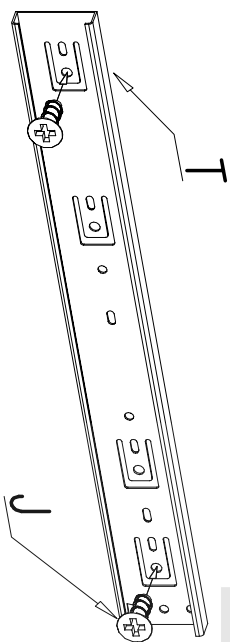

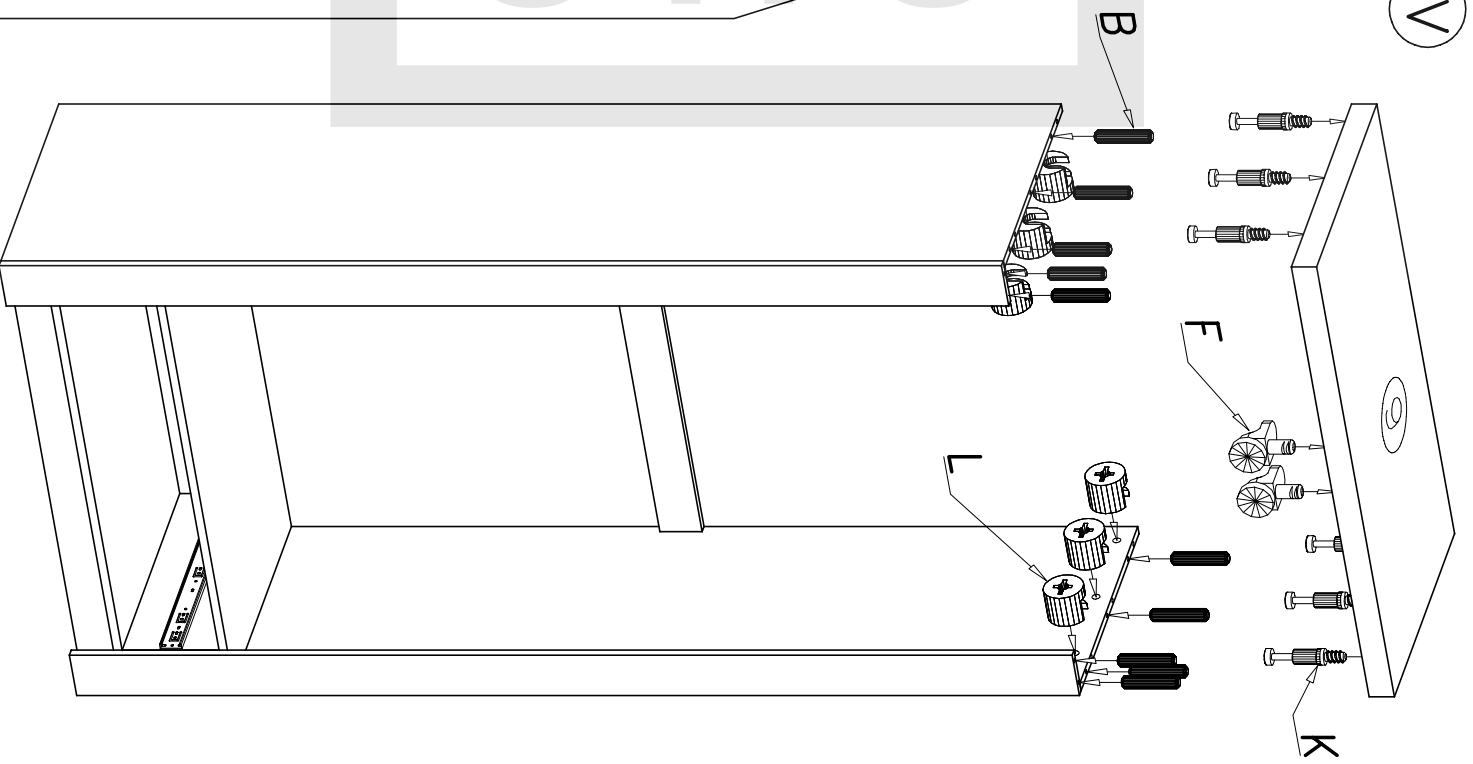
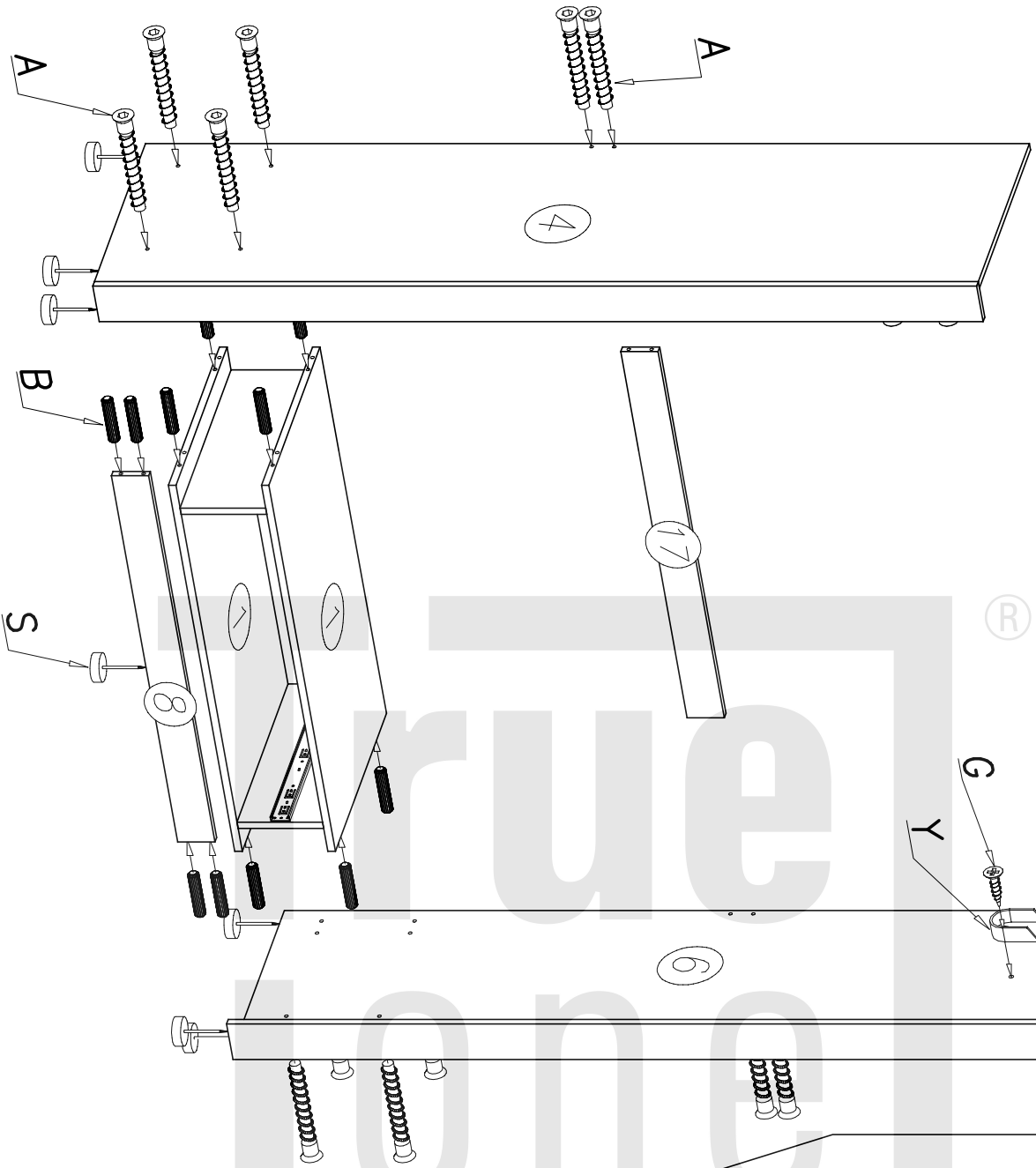

V

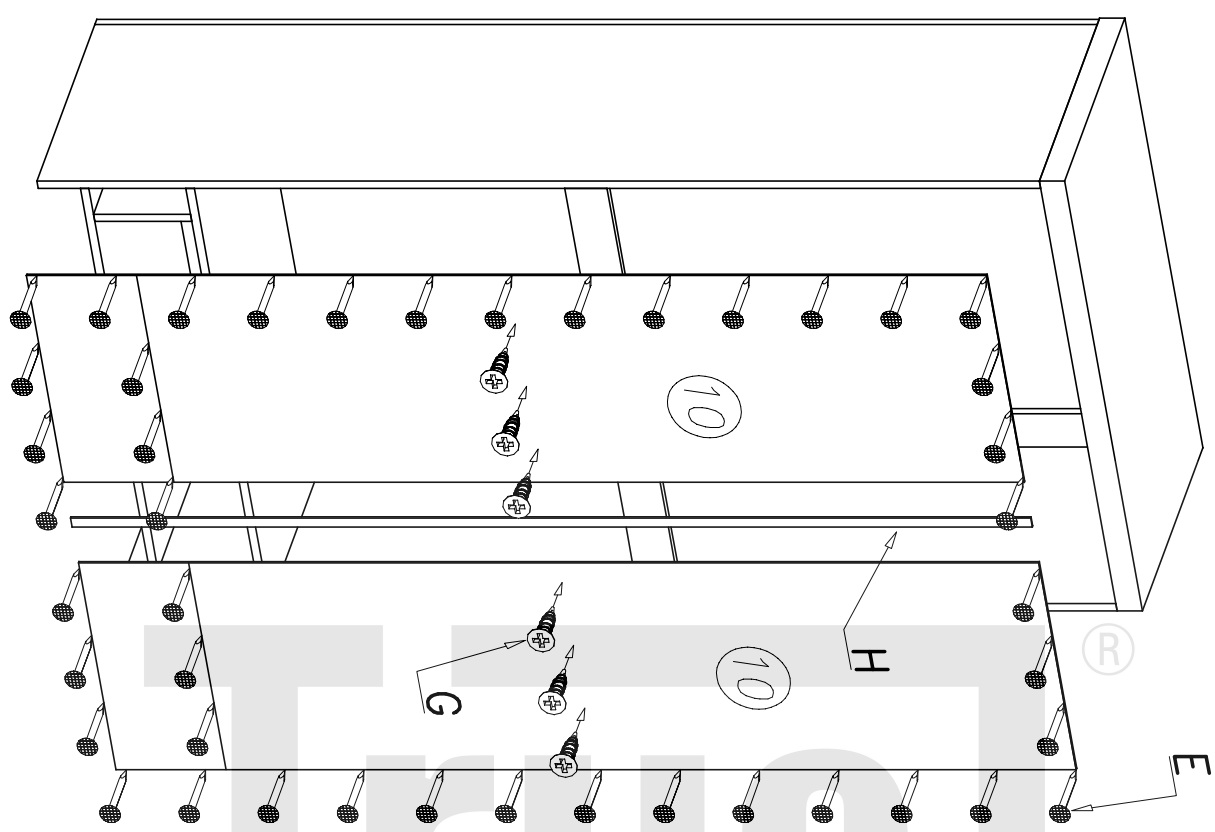

VI

